



Division 27

School District of Osceola County

Kevin McKenzie – RCDD / Kenny Shocklee – TIS
Revised November 1, 2021

SCHOOL DISTRICT OF OSCEOLA COUNTY

DIVISION 27

STANDARDS AND SPECIFICATIONS

TABLE OF CONTENTS

Section 27 00 00

COMMUNICATIONS SYSTEMS

Section 27 05 26

GROUNDING – BONDING

Section 27 05 28

PATHWAYS FOR COMMUNICATIONS SYSTEMS

Section 27 05 36

CABLE TRAYS FOR COMMUNICATIONS SYSTEMS

Section 27 11 10

TELECOMMUNICATIONS SPACES, EQUIPMENT AND FITTINGS

Section 27 13 13

COMMUNICATIONS COPPER BACKBONE CABLING

Section 27 13 23

COMMUNICATIONS OPTICAL FIBER BACKBONE CABLING

Section 27 15 13

COMMUNICATIONS HORIZONTAL COPPER CABLING

Section 27 15 43

COMMUNICATIONS FACEPLATES AND MODULES

Section 27 16 19

COMMUNICATIONS PATCH CORDS, STATION CORDS AND CROSS CONNECT CABLING

Section 27 21 33

WIRELESS ACCESS POINT SYSTEMS

Section 27 41 16

CLASSROOM AMPLIFICATION SYSTEM

Section 27 51 23

EDUCATIONAL INTERCOM AND PROGRAM CLOCK SYSTEM

Section 27 53 21

DISTRIBUTED ANTENNA SYSTEM – PUBLIC SAFETY

Section 28 10 00

ACCESS CONTROL

Section 28 20 00

VIDEO SURVEILLANCE

Section 28 30 00

INTRUSION DETECTION

PRE-APPROVED PRODUCT LIST
MASTER SYMBOLS
GENERAL NOTES
RESPONSIBILITY MATRIX
REVISION LOG

DETAILS

(FOR REFERENCE ONLY – NOT FOR GENERAL PUBLICATION)

ACCESS CONTROL
AUDIO ENHANCEMENT (ENCLOSURE)
BACKBOARD LAYOUT (CD / FD)
BALANCE BOX
BAS – SUPPORT OUTLET (DATA)
CAFETORIUM PROJECTOR PLATE
CAMERA BUILDOUT
CHARGING STATION (ADEPT4)
CHARGING STATION (JARS 1610)
CONDUIT – TRENCHING / BORING
DATA OUTLET (D4)
DATA OUTLET (CONDUIT)
EXTERIOR WAP BUILDOUT
GROUNDING BUS BAR
HANDHOLE (SMALL VAULT)
IDF (FD) CABINET
IDF (FD) RACK LAYOUT
IFSM OUTLET
IFSM CONDUIT-BOX ROUGHIN
IFSM TEACHING WALL CONFIGURATION
INTERIOR INTERCOM SPEAKER BUILDOUT
INTERIOR INTERCOM MESSAGE BOARD BUILDOUT
INTERIOR WAP BUILDOUT
INTERIOR WAP (WALL MOUNT) BUILDOUT
LABELING
MDF (CD) RACK LAYOUT
PROJECTOR PLATE ASSEMBLY
TEACHER STATION OUTLET
TEACHER STATION OUTLET (HUBBELL)
TERMINATION (568 A)
VAULT (COMMUNICATION)

SYSTEMS

(SEE DESIGN GUIDELINES – SDOC FACILITY DEPARTMENT)

(FOR REFERENCE ONLY – NOT FOR GENERAL PUBLICATION)

BACKBONE (BONDING) – RISER DIAGRAM
BACKBONE (CABLING / CONDUIT) – RISER DIAGRAM
CAFETORIUM AUDIO / VISUAL – BLOCK DIAGRAM
EMS / DAS – RISER DIAGRAM
GYMNASIUM SOUND SYSTEM – DIAGRAM
HIGH SCHOOL CAFETERIA (AUDIO / VISUAL) – BLOCK DIAGRAM
HIGH SCHOOL THEATER (AUDIO / VISUAL) – DIAGRAM
IDF (FD) SPACE CONFIGURATION – DIAGRAM
MDF (CD) SPACE CONFIGURATION – DIAGRAM
STADIUM SOUND SYSTEM – DIAGRAM
VIDEO WALL – DIAGRAM

TYPICAL ARCHITECTURAL / ENGINEERING DETAILS

(SEE DESIGN GUIDELINES – SDOC FACILITY DEPARTMENT)

(FOR REFERENCE ONLY – NOT FOR PUBLICATION)

BLACK BOX THEATER
CAFETORIUM (ELEMENTARY / MIDDLE)
CLASSROOM (ELEMENTARY)
CLASSROOM (ELEMENTARY SKILLS)
CLASSROOM (MIDDLE)
CLASSROOM (MIDDLE SKILLS – CONFIGURATION A)
CLASSROOM (MIDDLE SKILLS – CONFIGURATION B)
CLASSROOM (PORTABLE) W/ TEACHING WALL
CLASSROOM (PORTABLE) W/O TEACHING WALL
CONFERENCE ROOM
FRONT OFFICE SUITE (INCLUDING LOBBY)
GYMNASIUM
HIGH SCHOOL CAFETERIA
KITCHEN (INCLUDING SERVING AREA)
MEDIA CENTER
MUSIC SUITE
THEATER (HIGH SCHOOL)

[REMAINDER OF PAGE INTENTIONALLY LEFT BLANK]

COMMUNICATIONS SYSTEMS

PART 1 GENERAL:

1.1 INTRODUCTION:

- A. This document specifies School District of Osceola County (SDOC) requirements for a strategic direction for the physical connection of communications devices within SDOC facilities. A properly designed and constructed Structured Cabling System (SCS) will be adaptable to change over the life of SDOC facilities.
- B. The Contractor will meet certain qualifications listed under **Section 1.8 – QUALIFICATIONS**. The Contractor will be responsible for the execution of all work to install a complete, warranted, Structured Cabling System. Execution of work includes delivery, storage, preparation, installation, field-testing, and project completion tasks.
- C. The Contractor will comply with all current applicable codes, standards and regulations for all the work performed.
- D. The Structured Cabling System (SCS) will meet or exceed the performance requirements expressed in these documents. Contractors will be responsible for testing 100% of the cable runs and submitting the results to the manufacturer for a twenty-five (25) year applications warranty.
- E. The design and construction of the telecommunications system will:
 - 1. Provide telecommunications structure based on recognized standards to support efficient, long- lasting, and cost-effective operations.
 - 2. Reduce the amount of time required to install new Networks or to reconfigure existing local area Networks.
 - 3. Provide the flexibility to operate multiple high bandwidth technologies on a single structured cabling system.
 - 4. Eliminate the cost of installing non-standard, proprietary, and vendor-specific cabling by providing standards-based cabling systems that will support a wide variety of equipment.
 - 5. Allow for the growth of anticipated high speed, high bandwidth Networks that may be required by future specialized applications.

1.2 RELATED DOCUMENTS:

- A. Division 27 Sections that apply to this Section are:
 - 1. Section 27 05 26 Grounding & Bonding for Communications Systems
 - 2. Section 27 05 28 Pathways for Communications Systems
 - 3. Section 27 05 36 Cable Trays for Communications Systems
 - 4. Section 27 11 10 Telecommunications Spaces, Equipment and Fittings
 - 5. Section 27 13 13 Communications Copper Backbone Cabling
 - 6. Section 27 13 23 Communications Optical Fiber Backbone Cabling
 - 7. Section 27 15 13 Communications Horizontal Copper Cabling
 - 8. Section 27 15 43 Communications Faceplates and Modules
 - 9. Section 27 16 19 Communications Patch Cords and Station Cords
 - 10. Section 27 21 33 Wireless Access Point System
 - 11. Section 27 41 16 Classroom Amplification System
 - 12. Section 27 51 23 Educational Intercom and Program Clock System
 - 13. Section 27 53 21 Distributed Antenna System – Public Safety

1.3 STANDARDS AND CODES:

1. Effective telecommunications and networking cannot be accomplished without adherence to standards. Additionally, cabling infrastructure costs cannot be contained without adherence to sound installation and management practices. To ensure that the future telecommunications and connectivity needs of School District of Osceola County are met in a cost-effective manner, these documents confirm the support of the ANSI/TIA and IEEE standards for telecommunications.
2. American National Standards Institute, (ANSI) / Telecommunications Industry Association, (TIA) / Insulated Cable Engineers association, (ICEA) / Electronic Industries Alliance, (EIA):
 - a) ANSI/TIA-568.0-D
Generic Telecommunications Cabling for Customer Premises
 - b) ANSI/TIA-568.1-D
Commercial Building Telecommunications Infrastructure Standard
 - c) ANSI/TIA-568.2-D
Balanced Twisted-Pair Telecommunication Cabling and Components Standard
 - d) ANSI/TIA-568.3-D
Optical Fiber Cabling & Components Standard
 - e) ANSI/TIA-568.4-D
Coaxial Cabling Component Standard
 - f) ANSI/TIA/EIA-569-D
Commercial Building Standards for Telecommunications Pathways and Spaces
 - g) ANSI/TIA-607-C
Commercial Building Grounding and Bonding Requirements for Telecommunications
 - h) ANSI/TIA-942-A
Telecommunications Infrastructure for Data Centers
 - i) ANSI/TIA-1005-A
Industrial Telecommunications Infrastructure Standard
 - j) ANSI/TIA- 4966
Telecommunications Infrastructure Standard for Educational Facilities
 - k) ANSI/TIA-5017
Telecommunications Physical Network Security Standard
 - l) ANSI/ICEAS-83-596
Fiber Optic Premises Distribution Cable
 - m) ANSI/TIA/EIA-598
Color Coding of Optical Fiber Cables
 - n) ANSI/ICEAS-87-640
Fiber Optic Outside Plant Distribution Cable
 - o) ANSI/TIA/EIA-492AAAC
Detail Specification for 850nm Laser-Optimized 50um Core Diameter/125 um Cladding Diameter Class 1a Graded Index Multimode Optical Fibers
 - p) ANSI/TIA-492AAAE

Detail Specification for 50-um Core Diameter/125-um Cladding Diameter Class 1a Graded-Index Multimode Optical Fibers with Laser-Optimized Bandwidth Characteristics Specified for Wavelength Division Multiplexing

- q) ANSI/TIA/EIA-492CAAA
Detail Specification for Class Iva Dispersion-Unshifted Single Mode Optical Fibers
- r) ANSI/TIA/EIA-758
Customer-Owned Outside Plant Telecommunications Cabling Standard
- s) ANSI/TIA/EIA-526-7
Optical Power Loss Measurements of Installed Single Mode Fiber Plant: OFSTP-7
- t) ANSI/TIA/EIA-526-14-A
Optical Power Loss Measurements of Installed Multimode Fiber Plant: OFSTP-14A
- u) ANSI/TIA/EIA-TSB-125
Guidelines for Maintaining Optical Fiber Polarity Through Reverse-Pair Positioning
- v) ANSI/TIA/EIA-TSB-140
Additional Guidelines for Field Testing Length, Loss, and Polarity of Optical Fiber Cabling Systems
- w) ANSI/TIA/EIA-606-B
Administration Standard for Commercial Telecommunications Infrastructure
- x) ANSI/EIA-310-D
Cabinets, Racks, Panels, and Associated Equipment
- y) ANSI/TIA/EIA-604(SERIES)
FOCIS Fiber Optic Connector Intermateability Standard
- z) TIA-862-B
Structured Cabling Infrastructure Standard for Intelligent Building Systems
- aa) TIA-TSB-5021
Guidelines for the use of Installed Category 5e and Category 6 Cabling to Support 2.5GBASE-T AND 5GBASE-T

B. National Fire Protection Association, Inc., NFPA 70:

- 1. National Electric Code (NEC), latest edition:
 - a) NEC Article 250: Grounding
 - b) NEC Article 386: Surface Metal Raceways
 - c) NEC Article 388: Surface Non-Metallic Raceways
 - d) NEC Article 800: Communications Circuits
 - e) NEC Article 770: Optical Fiber Cables and Raceway

C. UNDERWRITER'S LABORATORY, INC. (UL)

- a) UL-5A: Standard for Non-Metallic Raceways and Fittings
- b) UL-5: Standard for Surface Metal Raceways and Fittings
- c) UL-5C: Standard for Surface Raceways and Fittings for use with Data, Signal, and Control Circuits
- d) UL-50: Standard for Enclosures for Electrical Equipment
- e) UL-94-V0: Tests for Flammability of Plastic Materials
- f) UL-498: Attachment Plugs and Receptacles

- g) UL-1479: Fire Tests of Through-Penetration Firestops (In Accordance with ASTM E814).
 - h) UL-1863: Standard for Safety of Communications Circuit Accessories
- D. NATIONAL ELECTRICAL MANUFACTURER'S ASSOCIATION (NEMA)
- a) ANSI/NEMA WD-6-2002: Wiring Devices – Dimensional Requirements
 - b) NEMA 250-2003: Enclosures for Electrical Equipment
- E. INTERNATIONAL STANDARDS ORGANIZATION (ISO) / International Electrotechnical Commission, (IEC)
- a) ISO/IEC 11801, Information Technology – Generic Cabling for Customer Premises
 - b) ISO/IEC 18010, Information Technology – Pathways and Spaces for Customer Premises Cabling
 - c) ISO/IEC 14763-1, Information Technology – Implementation and Operation of Customer Premises Cabling – Part 1: Administration
- F. FEDERAL COMMUNICATIONS COMMISSION (FCC) Title 47, Code of Federal Regulations, Part 68: Connection of Terminal Equipment to the Telephone Network
- G. U.S. PUBLIC LAW 336. 101ST CONGRESS, ADA: Americans with Disabilities Act of 1992.
- H. INSTITUTE OF ELECTRICAL AND ELECTRONICS ENGINEERS (IEEE)
- a) IEEE 802.3AF, Data Terminal Equipment (DTE) Power Over Media Dependent Interface (MDI) 15.4 WATTS
 - b) IEEE 802.3AT, Data Terminal Equipment (DTE) Enhanced Power Over Media Dependent Interface (MDI) 25 WATTS
 - c) IEEE 802.3BT, Data Terminal Equipment (DTE) Enhanced Power Over Media Dependent Interface (MDI) 60 WATTS
 - d) IEEE 802.3BZ-2016: IEEE Standard for Ethernet Amendment 7: Media Access Control Parameters, Physical Layers, and Management Parameters for 2.5 Gb/S and 5 Gb/S Operation
 - e) IEEE 802.3BP 1000BASE-T1 - Physical Layer Specifications and Management Parameters for 1 Gb/S Operation over a Single Twisted-Pair Copper Cable
 - f) IEEE 802.3BQ, IEEE Standard for Ethernet Amendment 3: Physical Layer and Management Parameters for 25 Gb/S and 40 Gb/S
 - g) IEEE 802.3AE, Specification for 10 Gbit/S Ethernet Operation Over Optical Fiber.
- I. Telecommunications Distribution Methods Manual, latest edition, Building Industry Consulting Services International (BICSI)
- J. Information Technology Systems Installation Methods Manual latest edition, Building Industry Consulting Services International (BICSI).
- 1.4 APPROVED PRODUCT MANUFACTURERS:
- A. The manufacturer of premise cable systems, that School District of Osceola County is using as basis of design in this document, as required for construction of the cabling infrastructure per contract documents shall be:
 - 1. Hubbell Premise Wiring
 - B. Product substitutions from other manufacturers shall require the approval of the Project Technology Designer (Project Electrical Engineer and Registered Communication Distribution Designer (RCDD)) and SDOC Technology Services Department Representative 10 business days prior to bid opening.
- 1.5 DESIGN CRITERIA:
- A. School District of Osceola County requires the following design criteria / standards:
 - 1. The project lead designer (Architect / Engineer) shall employ a BICSI Registered Communications Distribution Designer (RCDD) to serve as Technology Designer.
 - a) The Technology Designer (RCDD) shall review the technology infrastructure for adherence to all applicable standards and specifications.

- b) The Technology Designer (RCDD) shall perform periodic site visits to observe progress and ensure quality / performance during all phases of technology construction. These phases shall include, but are not limited to:
 - 1) Underground Rough-in
 - 2) Interior Rough-in / Mock-up
 - 3) Above Ceiling
 - 4) Telecom Space Build-out
 - 5) Substantial Completion
 - 6) Final Completion
 - 7) Systems Operational Testing
 - c) The Technology Designer (RCDD) shall perform a substantial completion inspection and develop a punch list of items to be corrected by the contractor.
 - d) The Technology Designer (RCDD) shall receive and review all cable certification test results (both copper UTP and Fiber Optic) provided by the contractor.
 - e) The Technology Designer (RCDD) shall conduct a final walkthrough with the owner's representative and the contractor to verify test results (10% retest) and punch list correction(s) for project acceptance.
2. All Technology drawings shall be an integrative set, (T-sheets), utilizing SDOC approved master symbols and general notes – **NO EXCEPTIONS**.
 3. All structured cabling, pathways, spaces, devices and assemblies shall be reflected on Technology drawings including, but not limited to:
 - a) IP camera locations – interior and exterior
 - b) Wireless Access Point locations – ceiling space above 11 feet shall include WAP locations at 10 feet maximum – interior and exterior
 - c) Intercom locations and components – interior and exterior
 - d) Classroom Amplification locations and components
 - e) Audio-visual presentation systems
 - f) Access Controls:
 - 1) Panels locations
 - 2) Door Controller locations
 - g) Fire Alarm monitoring – panel / locations / fiber optic or copper requirements
 - h) HVAC monitoring – including chiller plant control panels / auxiliary control panels / fiber optic or copper requirements / locations
 - i) DAS / EMS systems – including antenna locations / pathways / components / headend location / auxiliary locations
 - j) Lighting sensor locations – grayed out but present on all Technology drawings
 4. It is the Technology Design Consultant's (RCDD) responsibility to coordinate with the electrical engineer to ensure all technology power and lighting requirements are integrated into the electrical drawings.
 5. It is the Technology Design Consultant's (RCDD) responsibility to coordinate with the architect to ensure all technology furniture, fixture and equipment (FF&E) requirements are integrated into the FF&E drawings.
 6. All climate-controlled spaces shall incorporate a minimum of one (1) D2 data outlet with electrical outlet within 12 inches of data outlet unless otherwise noted (U.O.N).
 7. All electrical outlets shall incorporate a USB convenience outlet for student usage (minimum 3 outlets per classroom / office location) unless otherwise noted (U.O.N).

8. All electrical outlets associated with data outlets and / or electronic components shall not be controlled by occupancy sensors – **NO EXCEPTIONS**
9. All materials, equipment, and installation shall be Contractor provided unless otherwise noted (U.O.N).

1.6 STRUCTURED CABLING SYSTEM (SCS):

- A. School District of Osceola County requires following the general cabling industry practice of using a SCS. Other cabling systems may be installed in addition to the SCS, but as a minimum, School District of Osceola County requires that a SCS be installed. A properly designed SCS allows the Contractor to fulfill the telecommunications needs without knowing specifically what electronic equipment will be utilized. The SCS is geared for long-term stability and flexibility and is based on the idea of cabling buildings once. The SCS approach allows the cable and telecommunications outlets to remain unchanged as connections and services vary.
- B. There are typically five major components of the SCS as follows:
 1. Section 27 00 00 Communications
 2. Section 27 10 00 Structured Cabling
 3. Section 27 20 00 Data Communications
 4. Section 27 40 00 Audio-Video Communications
 5. Section 27 50 00 Distributed Communications and Monitoring Systems

1.7 SCOPE:

- A. School District of Osceola County requires a uniform cabling plan in each building for data, wireless, signage and video distribution to allow for flexible changes, office renovations, equipment migrations and constant upgrades. This cabling system will be based on industry standard SCS's that are not proprietary and conform to current ANSI/TIA Commercial Cabling Standards.

1.8 QUALIFICATIONS:

- A. Telecommunications Installer:
 1. Qualifications for System Installer:
 - a) The Contractor will have experience in the installation and testing of similar systems as specified herein and will have completed at least two projects of similar size and scope within the last 24 months. The Contractor will provide references upon request (including the project name, address, date of implementation, client name, title, telephone number, and project description).
 - b) All members of the installation team must be certified by the manufacturer as having completed the necessary training to complete their part of the installation. All personnel will be adequately trained in the use of such tools and equipment as required.
 - c) The Contractor bidding on communication systems specified herein will be certified by the connectivity manufacturer to install, service, and warranty the specified product prior to the time of bid and throughout the duration of the installation. Manufacturer certifications will not be project specific and should be valid for all projects completed by Contractor.
 - d) The Contractor must be certified to install a certified fire-stop system.
 - e) The Contractor will own and maintain tools, installation equipment, and test equipment necessary for successful installation and testing of optical fiber, Category 6, and 6a premise distribution systems.
 - f) The Contractor must maintain a state issued Contractor's license, as required by the state.
 - g) The Contractor installing the structured cabling will have a Registered Communication Distribution Designer (RCDD) and a Project Superintendent.
 - 1) The installation company will have an RCDD on staff performing the role of Project Manager, to be available for consultation and to attend project meetings. In addition, the Contractor will appoint a site superintendent to provide onsite support and make decisions regarding the scope of work and changes required by the work. The same person may function as both.
 - h) The Contractor will have an RCDD on staff that will ultimately be responsible for this project. The RCDD will have sufficient experience in this type project and be able to lend adequate technical support to

the field forces during installation, during the warranty period and extended warranty periods or maintenance contracts. The credentials (current BICSI certification) must be available.

- i) The Contractors' Project Manager and site superintendent will act as primary points of contact for activities regarding this project.
- j) School District of Osceola County authorized personnel may, with full cooperation of the Contractor, visit installations to observe equipment operations and consult with references. Specified visits and discussion will be arranged through the Contractor; however, the Contractor's RCDD and Project Superintendent must both be in attendance to answer or discuss any questions or issues that are brought up. The Contractor will make notes and distribute them to School District of Osceola County authorized personnel within 48 hours.
- k) The site superintendent will be required to make on-site decisions regarding the scope of the work and changes required by the work. The site superintendent will be on the jobsite whenever work is being performed or workers are present.
- l) The Project Manager will notify the Project Technology Designer (Project Electrical Engineer and Registered Communications Distribution Designer (RCDD)), and SDOC Technology Services Department Representative of change requests and inspections. Final approval for change requests must be obtained from Project Technology Designer (RCDD) and SDOC Technology Services Department Representative prior to commencement of work.
- m) Contractor's installation team will take **pride and ownership** of all aspects of the installation.

1.9 QUALITY ASSURANCE:

- A. Manufacturer:
 - 1. Firms regularly engaged in manufacture of the materials, called out for in this section, whose products have been in satisfactory use in similar service for not less than 3 years.
- B. The Contractor will install work in accordance with the latest School District of Osceola County Requirements, the latest BICSI Information Technology Systems Installation Methods Manual, Telecommunications Distribution Methods Manual, TIA/EIA Standard Commercial Building Telecommunications Cabling Standard, systems planning and design manual.
- C. The Contractor who is installing the materials and installing the system will be trained by the referenced manufacturer in the proper installation practices. The Contractor will have proper tools and test equipment to insure a good and proper installation.
- D. Installed UTP and fiber cabling systems, pathways and distribution facilities will adhere to manufacturer's instructions, contract drawings and specifications, and applicable codes, standards and regulations.
- E. Installed UTP cabling systems and field test results will strictly adhere to requirements of ANSI/TIA-568-0.D, ANSI/TIA-568-1.D and ANSI/TIA/EIA-568-2.D.
- F. Installed optical fiber cabling systems and field test results will strictly adhere to requirements of ANSI/TIA-568-0.D AND ANSI/TIA/EIA-568-3.D.
- G. Where applicable, all equipment, components, accessories and hardware will be UL listed for the intended purpose of the installation.
- H. All critical internal manufacturing operations for installed products will have documented in-process inspection and testing according to ISO9001.
- I. Installed products will be manufactured by an ISO9001 certified facility.
- J. Installed products will be free from defects in material or workmanship from the manufacturer and will be of the quality indicated.
- K. All methods of construction that are not specified in the contract documents will be subject to control and approval by the Project Technology Designer (RCDD) and SDOC Technology Services Department Representative.
- L. Inspection Requests shall be requested a **minimum of three (3) business days** prior to inspection date.
- M. Installed products will be lot-traceable by date code.

1.10 SUBMITTALS:

- A. The Contractor will submit shop drawings, a bill of material and product data to the Project Technology Designer (RCDD), School District of Osceola County Project Manager, and School District of Osceola County Technology Services Department Representative for review and approval prior to commencement of work.
- B. The Contractor will submit two (2) similar project references.
- C. The Contractor will submit the project's RCDD's credentials.
- D. The Contractor will submit a list of JLA cleared employees that will be on-site for the project. This list will be updated to accommodate fluctuations in the work force.
- E. All JLA cleared employees will be registered with the School District of Osceola County's Human Resources Department.
- F. The Contractor will submit the certificates from the Manufacturer for each worker that will be working on the project.
- G. The Contractor will indicate installation details, cable routing, system configuration, and outlet numbering on all technology shop drawings.
- H. The Contractor will submit appropriate product data for each component to be supplied.
- I. The Contractor will submit manufacturer's installation instructions
- J. The Contractor will submit three copies and an electronic PDF file of a complete, bound, project record manual consisting of the following:
 - 1. Product cut sheets for products supplied
 - 2. The certificate of calibration for each tester used on the project, dated no more than one (1) year from the date of use
 - 3. Test reports for horizontal cabling
 - 4. Test reports for backbone cabling – including fiber optic cabling
 - 5. Manufacturer's warranties
 - 6. As-built drawings
 - a) The As-built drawings will accurately record location of service entrance conduit, termination backboards, outlet boxes, labeling, cable raceways, cable trays, penetrations, mechanical fire barriers, pull boxes, vaults, and equipment racks electronically using AutoCAD's latest version.

1.11 WARRANTIES:

- A. The Contractor will furnish a manufacturer's warranty of products, applications and workmanship for 25 years from the date of acceptance by School District of Osceola County. Products and workmanship will carry warranties equal to or greater than the warranty from the date of acceptance by the state.
- B. Materials and workmanship will be fully guaranteed by the Contractor for 25 years from transfer of title against defects. The defects which may occur, as the result of faulty materials or workmanship within 25 years after installation and acceptance by School District of Osceola County will be corrected by the Contractor at no additional cost to School District of Osceola County.
- C. The Contractor will promptly, at no cost to School District of Osceola County, correct or re-perform (including modifications or additions as necessary) nonconforming or defective work within 25 years after completion of the project.
- D. The Contractor will procure equipment and materials that carry warranties against defects and workmanship whenever available. The Contractor will transfer to School District of Osceola County additional warranties offered by the manufacturers, at no additional cost to School District of Osceola County.
- E. The Contractor's obligation under its warranty is limited to the cost of repair of the warranted item or replacement thereof, at the Contractor's option. Insurance covering said equipment from damage or loss is to be borne by the Contractor until full acceptance of equipment and services.
- F. At the end of the project, the telecommunications Contractor will provide one set of the revised as-built drawings accurately showing all termination locations, cable routing, and labeling.

G. As-Built Document Requirements:

1. (1) Hard Copy of the Drawings and Test Reports as well as (1) Complete Data File of the Drawings and Test Reports including the Summary Reports on a Flash Drive

1.12 MATERIALS:

- A. Contractor will be an authorized installing agent / company with full warranty privileges for the following premise distribution enterprise cabling systems (and approved partners) solutions:
 1. Hubbell Premise Wiring
- B. Product substitutions from other manufacturers will require the approval of the Project Technology Designer (Project Electrical Engineer and Registered Communication Distribution Designer (RCDD)) and SDOC Technology Services Department Representative 10 business days prior to bid opening.
- C. All materials will be UL or ETL listed and verified and will be marked as such.
- D. Products will be regularly catalogued items of the manufacturer and will be supplied as a complete unit in accordance with the manufacturer's standard specifications with any optional items required for proper installation unless otherwise noted.
- E. All materials used on this project will be new. Used and refurbished equipment is not permitted. Provide equipment to site in original packaging whenever practical.

1.13 DELIVERY, STORAGE AND HANDLING LOGISTICS:

- A. Material will be delivered to the site in the original packing.
- B. Materials delivered to the construction site will be stored in a dry, secure area, preferably indoors. Storage temperature of materials will adhere to manufacturer's recommendations. Movement of packaged materials will be in a manner to avoid damage of contents. On-site storage, either indoors or trailer, will have permission of School District of Osceola County Staff, and will not interfere with other construction activity.
- C. Installation of Category rated cable will be within the recommended temperature range specified by the manufacturer. Cable installation temperature range between 50°F and 80°F is recommended. Cabling should only be installed in facilities that are not exposed to the elements.
- D. The Contractor is responsible for scheduling all deliveries and providing proper receipt, handling, and storage of all materials. Protect all equipment from physical damages (dents, scratches, dust, water, **paint**, chemicals, and temperature extremes) and vandalism, or theft. The Contractor will replace any damaged or stolen equipment. The Contractor is responsible for all equipment until final project acceptance by School District of Osceola County.
- E. The Contractor is responsible for cleaning the worksite every business day and removing debris from the facility.

1.14 COORDINATION WITH OTHER TRADES:

- A. Coordinate layout of work with other trades. Make minor adjustments in locations required for coordination. Locations of structural systems, heating work and plumbing lines will take preference over locations of conduit lines where conflict occurs. Structural systems, heating work, and plumbing lines will not interfere with or otherwise impede the routing of communication cabling with cable tray, raceways, or other pathways dedicated to communications. All potential issues will be brought to the attention of the General Contractor, Construction Manager, Architect, Engineer, Project Technology Designer (RCDD), and SDOC Technology Services Department Representative immediately, before proceeding with installation.
- B. Other than minor issues, adjustments will be submitted to the General Contractor, Construction Manager, Architect, Engineer, Project Technology Designer (RCDD), and SDOC Technology Services Department Representative for approval before proceeding with the work.
- C. Coordinate locations, arrangement, mounting, and support of all communications provisions with Division 26 Representative, Project Technology Designer (RCDD), SDOC Technology Services Department Representative that:
 1. Allow maximum possible headroom unless specific mounting heights that reduce headroom are indicated.
 2. Provide for ease of disconnecting the equipment with minimum interference to other installations.

3. Allow right of way for piping and conduit installed at required slope.
4. Coordinate that connecting raceways, cables, and cable trays will be clear of obstructions and of the working and access space of other equipment.
5. Coordinate installation of required supporting devices and set sleeves in cast-in-place concrete, masonry walls, and other structural components as they are constructed.
6. Coordinate sleeve selection specified in Division 07 and Division 26.
7. Coordinate location of access panels and doors for electrical items that are behind finished surfaces or otherwise concealed.
8. Coordinate the gauge cables to be used in the telecommunications grounding system.

PART 2 PRODUCTS:

Not Used

PART 3 EXECUTION:

Not Used

END OF SECTION 27 00 00

[REMAINDER OF PAGE INTENTIONALLY LEFT BLANK]

GROUNDING & BONDING FOR COMMUNICATIONS SYSTEMS

PART 1 GENERAL:

1.1 INTRODUCTION:

- A. The purpose of this section is to enable the installation of generic telecommunications bonding systems within a premise that will allow for the safest and best way to protect the telecommunications system and equipment.
- B. The bonding and grounding systems within a building are intended to have one electrical potential for the safety of people and equipment throughout the facility.
- C. Whereas the primary purpose of the electrical grounding system is safety, the telecommunication's grounding system is intended to provide enhanced equipment protection and system performance.
- D. While the bonding and grounding of the electrical service entrance is outside the scope of the referenced standard, coordination between electrical and telecommunications bonding systems is essential for the proper application of this standard.
 - 1. Electrical rooms, electrical panel board(s) and connection to the Electrical Distribution Panel are not part of the telecommunications infrastructure, but they are depicted in this standard because they are integral to the telecommunications bonding system.

1.2 RELATED DOCUMENTS:

- A. Division 27 Sections that apply to this Section are:
 - 1. Section 27 00 00 Communications
 - 2. Section 27 05 28 Pathways for Communications Systems
 - 3. Section 27 05 36 Cable Trays for Communications Systems
 - 4. Section 27 11 10 Telecommunications Spaces, Equipment and Fittings
 - 5. Section 27 13 13 Communications Copper Backbone Cabling
 - 6. Section 27 13 23 Communications Optical Fiber Backbone Cabling
 - 7. Section 27 15 13 Communications Copper Horizontal Cabling
 - 8. Section 27 15 43 Communications Faceplates and Modules
 - 9. Section 27 16 19 Communications Patch Cords and Station Cords
 - 10. Section 27 21 33 Wireless Access Point Systems
 - 11. Section 27 41 16 Classroom Amplification System
 - 12. Section 27 51 23 Educational Intercom and Program Clock System
 - 13. Section 27 53 21 Distributed Antenna System – Public Safety

1.3 STANDARDS AND CODES:

- A. Refer to Section 27 00 00 – Communications
- B. Refer to Division 01 – Reference Standards and General Conditions of the Contract
- C. Complies with both ANSI/TIA-607-C and NEC Article 250. The most stringent rules apply.

1.4 APPROVED PRODUCT MANUFACTURERS:

- A. The manufacturer of the materials in this section, that School District of Osceola County is using as basis of design in this document, as required for construction of the cabling infrastructure per contract documents shall be:
 - 1. Hubbell Premise Wiring

- B. Product substitutions from other manufacturers shall require the approval of the Project Technology Designer (Project Electrical Engineer and Registered Communication Distribution Designer (RCDD)) and SDOC Technology Services Department Representative 10 business days prior to bid opening.

1.5 SUBMITTALS:

A. Shop Drawings:

- 1. Shop drawing will indicate the location of cable routes, bundle sizes, and penetrations (including cable trays, mechanical firestops, and interior / exterior sleeving), and will require the approval of the Project Technology Designer (Project Electrical Engineer and Registered Communication Distribution Designer (RCDD)) and SDOC Technology Services Department Representative prior to implementation.

B. Submit Manufacturer's Cut Sheets for the following: Refer to Section 27 00 00 – Communications Submittal.

- 1. Major items not included in the product section of the specification.
- 2. Submit Manufacturer's Cut Sheets for the following:
 - a) PBB busbar (TMGB)
 - b) SBB busbar (TGB)
 - c) RBB busbar (rack busbars)
 - d) UL497 Primary Protector for Communication Circuits
 - e) Advanced Solid-state primary telecommunications five pin surge protection module
 - f) Advance High speed fused solid state secondary surge protection module
 - g) Irreversible Crimp Style – Two-hole lugs
 - h) No. 750 kmil to No. 6 AWG conductors (products used in system)
 - i) Report of field tests and observations.

1.6 QUALITY ASSURANCE:

A. Manufacturers:

- 1. Firms regularly engaged in manufacture of electrical connectors, terminals and fittings of types and rating required, and ancillary grounding materials, including stranded cable, copper braid and bus, ground rods and plate electrodes, whose products have been in satisfactory use in similar service for not less than 3 years.

B. Installer:

- 1. Qualified with at least 3 years of successful installation experience on projects with technology groundwork similar to that required for this project.

C. Listing and labeling:

- 1. Provide products specified in this Section that are listed and labeled. The terms "listed" and "labeled" shall be defined as they are in the National Electric Code, Article 100.

D. Listing and Labeling Agency Qualifications:

- 1. A "Nationally Recognized Testing Laboratory" (NRTL) as defined in OSHA Regulation 1910.7.

E. Component Standard:

- 1. Components and installation shall comply with NFPA 70, "National Electric Code" (NEC).

F. UL Compliance:

- 1. Comply with applicable requirements of UL Standards Nos. 467 and 869 pertaining to electrical and electronic grounding.

G. IEEE Compliance:

- 1. Comply with applicable requirements of IEEE Standard 142 and 241 pertaining to electrical and electronic grounding.

1.7 DEFINITION:

A. TBC (Telecommunications Bonding Conductor):

1. The TBC bonds the PBB to the service equipment (power) ground.
- B. PBB (Primary Bonding Busbar):
1. The PBB serves as the dedicated extension of the building grounding electrode system for the telecommunications infrastructure. The PBB also serves as the central attachment point for the TBB(s) and equipment. Typically installed in the entrance facility or entrance room, and is bonded to the service equipment (power) ground by the TBC (Telecommunication Bonding Conductor).
- C. SBB (Secondary Bonding Busbar):
1. The SBB is the bonding connection point for telecommunications systems and equipment in the area served by a distributor. A copper ground reference busbar, typically installed in Telecommunication Rooms (TR) and is bonded to the PBB by the TBB. The SBB references metallic entities in the TR space to ground.
- D. RBB (Rack Bonding Busbar):
1. The RBB is a busbar that is placed inside or on the equipment cabinets or racks. It is used to bond the cabinets / rack / active electronics / shielded products to the system. It is connected to the system by being attached to the RBC.
- E. TBB (Telecommunications Bonding Backbone):
1. An insulated copper conductor extending from the PBB to each SBB. The TBB is a conductor that interconnects all SBBs with the PBB. The intended function of a TBB is to reduce or equalize potential differences.
- F. TEBC (Telecommunications Equipment Bonding Conductor):
1. The TEBC connects the busbar to equipment racks/cabinets. More than one TEBC may be installed in a distributor. The TEBC shall be a continuous copper conductor that is sized not less than a #6 AWG or as the largest size equipment grounding conductor in the ac branch power circuit(s) serving the racks / cabinet lineup.
- G. BBC (Backbone Bonding Conductor):
1. When there are multiple TBBs, the BBC is employed to interconnect them through the associated busbars, either on the same floor in a multi-story building or in the same general area of a single-story building.
- H. RBC (Rack Bonding Conductor):
1. A conductor, typically a #6 AWG, that attaches from the TEBC to RBB.
- I. Primary Surge Protection (Building Entrance Application):
1. A device whose primary function is to protect building entrance terminations from surge voltage usually incorporating a 110-block style connection system and 5-pin module fuse system for analog copper cabling applications.
- J. Secondary Surge Protection (Intra-Building Application):
1. A device whose primary function is a secondary surge protection termination from surge voltage usually incorporating a 66-block style connection system and cross pin module fuse system for analog copper cabling applications.

1.8 WARRANTIES:

- A. Refer to Section 27 00 00 for general details.

1.9 MATERIALS:

- A. All materials shall be UL or ETL listed and verified and shall be marked as such.
- B. Products shall be regularly catalogued items of the manufacturer and shall be supplied as a complete unit in accordance with the manufacturer's standard specifications with any optional items required for proper installation unless otherwise noted.
 1. All materials used on this project shall be new. Used and refurbished equipment is not permitted. Provide equipment to site in original packaging wherever practical.

1.10 DELIVERY, STORAGE AND HANDLING LOGISTICS:

- A. Material shall be delivered to the site in the original packing.
- B. Materials delivered to the construction site shall be stored in a dry, secure area, preferably indoors. Storage temperature of materials shall adhere to manufacturer's recommendations. Movement of packaged materials shall be in a manner to avoid damage of contents. On-site storage, either indoors or trailer, shall have permission by the School District of Osceola County Staff, and shall not interfere with other construction activity.
- C. Installation of cables shall be within the recommended temperature range specified by the manufacturer. Cable installation temperature range between 50°F and 80°F is recommended. Cables should only be installed in facilities that are not exposed to the elements.
- D. The contractor is responsible for scheduling all deliveries and providing proper receipt, handling, and storage of all materials. Protect all equipment from physical damages (dents, scratches, dust, water, paint, chemicals, and temperature extremes) and vandalism, or theft. The contractor shall replace any damaged or stolen equipment. The contractor is responsible for all equipment until final project acceptance by owner.
- E. The contractor is responsible for cleaning the worksite every business day and removing debris from the facility.

1.11 COORDINATION WITH OTHER TRADES:

- A. Coordinate layout of work with other trades. Make minor adjustments in locations required for coordination. Locations of structural systems, heating work and plumbing lines shall take preference over locations of conduit lines where conflict occurs. Structural systems, heating work, and plumbing lines shall not interfere with or otherwise impede the routing of communication cabling with cable tray, raceways, or other pathways dedicated to communications. All potential issues shall be brought to the attention of the General Contractor, Construction Manager, Architect, Engineer, Project Technology Designer (RCDD), and SDOC Technology Services Department Representative immediately, before proceeding with installation.
- B. Other than minor issues, adjustments shall be submitted to the General Contractor, Construction Manager, Architect, Engineer, Project Technology Designer (RCDD), and SDOC Technology Services Department representative for approval before proceeding with the work.
- C. Coordinate locations, arrangement, mounting, and support of all communications provisions with Division 26 Representative, Project Technology Designer (RCDD), SDOC Technology Services Department representative that:
 - 1. Allow maximum possible headroom unless specific mounting heights that reduce headroom are indicated.
 - 2. Provide for ease of disconnecting the equipment with minimum interference to other installations.
 - 3. Allow right of way for piping and conduit installed at required slope.
 - 4. Coordinate that connecting raceways, cables, and cable trays will be clear of obstructions, the working and access space of other equipment.
 - 5. Coordinate installation of required supporting devices and set sleeves in cast-in-place concrete, masonry walls, and other structural components as they are constructed.
 - 6. Coordinate sleeve selection and application with selection and application of fire stopping specified in Division 07 and Division 26.
 - 7. Coordinate location of access panels and doors for electrical items that are behind finished surfaces or otherwise concealed.
 - 8. Coordinate the gauge cables to be used in the telecommunication grounding system.

PART 2 PRODUCTS:

2.1 REFERENCE PART NUMBERS:

- A. Bidder shall confirm all reference part numbers, listed within Division 27's Pre-Approved Product List, as current and suitable for the items described and specified and shall file a formal RFI for all perceived discrepancies prior to bidding.
- B. All materials associated with reference parts shall be included so as to constitute a complete and functional system, whether or not specifically identified, itemized, and quantified.

2.2 COMPONENTS:

- A. Busbars:
1. Primary Busbar (PBB):
 - a) The PBB shall be provided with holes for use with correctly matched listed lugs and hardware. No solid busbars that require the contractor to drill holes will be permitted.
 - b) The busbars shall be made of copper or copper alloys having a minimum of 95% conductivity when annealed as specified by the International Annealed Copper Standard (IACS). Aluminum or Tin-plated busbars are not allowed.
 - c) Dimensions: 4.0"W X 20"L X .25"T
 - d) The busbar must be UL listed and tested by a Nationally Recognized Testing Laboratory.
 - e) The busbar will be insulated from its support and maintain a 2" minimum clearance from the wall.
 2. Secondary Busbar (SBB):
 - a) The SBB must be provided with holes for use with correctly matched listed lugs and hardware. No solid busbars that require the contractor to drill holes will be permitted.
 - b) The busbars shall be made of copper or copper alloys having a minimum of 95% conductivity when annealed as specified by the International Annealed Copper Standard (IACS). Aluminum or Tin-plated busbars are not allowed.
 - c) Dimensions: 2.0"W X 10"L X .25"T
 - d) The busbar must be UL listed and tested by a Nationally Recognized Testing Laboratory.
 - e) The busbar will be insulated from its support and maintain a 2" minimum clearance from the wall.
 3. Rack Busbar (RBB):
 - a) The RBB must be provided with holes for use with correctly matched listed lugs and hardware. No solid busbars that require the contractor to drills holes will be permitted.
 - b) The busbars shall be made of copper or copper alloys having a minimum of 95% conductivity when annealed as specified by the International Annealed Copper Standard (IACS). Aluminum or Tin-plated busbars are not allowed.
 - c) The busbar must be UL listed and tested by a Nationally Recognized Testing Laboratory.
 - d) No copper tapes will be allowed.
- B. Primary / Secondary Surge Protection System:
1. Primary Surge Protection (Building Entrance Termination):
 - a) UL497 Primary Protector for Communication circuits.
 - b) 16 AWG Powder Coated Steel Construction
 - c) Equipped with an internal 26 AWG FuseLink
 - d) External Ground Connectors Accept #6 – #14 AWG wire
 - e) Industry Standard 5 Pin Design
 - f) Exceeds UL497 Primary Protection Standards
 - g) 110 Connector Accepts #22 – #26 AWG wire
 2. Secondary Surge Protection (Intra-Building Termination):
 - a) Exceeds UL497B isolated loop circuit protector
 - b) Used in conjunction with Primary Surge Protection (UL497)
 - c) Protection modules elements switch from normal high impedance state to low impedance state upon detection of surge – returns to high impedance state after surge passes.
 - d) Modules require MGB ground rail (66 block application)
- C. Lugs:
1. All lugs will be solid copper construction.

2. UL and CSA Listed.
 3. All lugs will be long barrel, color coded, irreversible crimp style, and have two holes.
- D. Cable:
1. Color: **Green**
 2. All bonding conductors shall be copper and may be insulated. When conductors are insulated, they shall be listed for the application (plenum or riser).
 3. Bare copper conductors may be used in plenum areas, but they must be protected.
 4. Bend radius – 8 inches.
 5. A minimum angle of 90° shall be used.

PART 3 EXECUTION:

3.1 PLACEMENT OF SURGE PROTECTION SYSTEMS:

A. Primary Surge Protection:

1. The desirable location of the Primary Surge Protector is in the Telecommunication Entrance Room.
2. There should be a single Primary Surge Protector per building.
3. For buildings with more than one primary analog copper cable entrance, the user is urged to consult with a licensed engineer for guidance on locating the Primary Surge Protector.
4. A practical location for the Primary Surge Protector is at the entrance location of the analog copper cable entrance (where provided) and clear of other cabling and grounding infrastructure.
5. The vertical location of the Primary Surge Protector should be determined by considering whether the bonding conductors are routed in an access floor or overhead cable support.
6. The placement of the Primary Surge Protector should be installed for the shortest and straightest practical routing to the Telecommunications Bonding Conductor (TBC) and the primary protector grounding conductor.

B. Secondary Surge Protection:

1. The desirable location of the Secondary Surge Protector is in the Telecommunication Room.
2. There should be a single Secondary Surge Protector per floor.
3. For buildings with more than three secondary analog copper cable entrances, the user is urged to consult with a licensed engineer for guidance on locating the Secondary Surge Protector.
4. A practical location for the Secondary Surge Protector is at the entrance location of the analog copper cable entrance (for each floor) and clear of other cabling and grounding infrastructure.
5. The vertical location of the Secondary Surge Protector should be determined by considering whether the bonding conductors are routed in an access floor or overhead cable support.
6. The placement of the Secondary Surge Protector should be installed for the shortest and straightest practical routing to the Telecommunications Bonding Conductor (TBC) and the primary protector grounding conductor.

3.2 PLACEMENT OF BUSBARS:

A. PBB (TMGB):

1. The desirable location of the PBB is in the Telecommunications Entrance Room.
2. There should be a single PBB per building.
3. For buildings with more than one electrical service entrance, each of which serves telecommunication equipment, the user is urged to consult with a licensed engineer for guidance on locating the PBB.
4. The PBB shall be located at least 3 feet away from the panel board (electrical power panel) and shall be installed to maintain clearances required by applicable electrical codes.
5. A practical location for the PBB is off to the side of the panel board (where provided) and clear of other cabling and grounding infrastructure.

6. The vertical location of the PBB should be determined by considering whether the bonding conductors are routed in an access floor or overhead cable support.
 7. When a panel board for telecommunication equipment is not installed in the Telecommunications Entrance Room, the PBB should be located near the backbone cabling and associated terminations.
 8. The placement of the PBB should be installed for the shortest and straightest practical routing of the Telecommunications Bonding Conductor (TBC) and the primary protector grounding conductor.
 9. The PBB shall be insulated from its support using an insulator that is listed for the purpose by a Nationally Recognized Testing Laboratory (NRTL).
 10. A minimum of 2 inches separation from the wall is recommended to allow access to the rear of the busbar.
 11. The PBB should serve telecommunication equipment that are located within the same room or space.
 12. The PBB serves as the central bonding busbar for the telecommunications bonding infrastructure.
 13. All equipment located in the entrance facility will be attached to the PBB.
 14. All cables that enter the Entrance Facility with an armored jacket will be bonded to the PBB.
 15. All ladder rack(s), Basket tray(s) and conduit(s) that leave the entrance facility will be bonded to the PBB.
 16. The busbar shall be cleaned, and an antioxidant should be applied prior to fastening connectors to the busbar.
 17. All hardware (bolts, washers and nuts) that attaches to the PBB will be stainless steel.
- B. SBB (TGB):
1. The desired location of the SBB is in the Campus or Floor Distribution Rooms.
 2. The SBB shall be located at least 3 feet away from the panel board (electrical power panel) and shall be installed to maintain clearances required by applicable electrical codes.
 3. The vertical location of the SBB should be determined by considering whether the bonding conductors are routed in an access floor or overhead cable support.
 4. When a panel board for telecommunication equipment is not installed in the Telecommunications Entrance Room, the SBB should be located near the backbone cabling and associated terminations.
 5. The SBB shall be insulated from its support using an insulator that is listed for the purpose by a Nationally Recognized Testing Laboratory (NRTL).
 6. A minimum of 2 inches separation from the wall is recommended to allow access to the rear of the busbar.
 7. The SBB should serve telecommunication equipment that is located within the same room or space.
 8. Where a panel board is located in the same room or space as the SBB that panel board's ACEG bus (when equipped) or the panel board enclosure shall be bonded to the SBB.
 9. When a panel board for telecommunications equipment is not in the same room or space as the SBB, that SBB should be bonded to the panel board that feeds the distributor.
 10. The TBBs and other SBBs within the same space shall be bonded to the SBB with a conductor the same size as the TBB. In all cases, multiple SBBs within a room shall be bonded together with a conductor the same size as the TBB or with splice bars.
 11. Where a backbone bonding conductor (BBC) is required, it shall be bonded to the SBB.
 12. The TEBC will be attached to the SBB.
 13. All metallic pathways for telecommunications cabling located within the same room or space as the SBB shall be bonded to the SBB.
 14. All ladder rack(s), Basket tray(s) and conduit(s) that are used within the distributor will be bonded to the SBB.
 15. The busbar shall be cleaned, and an antioxidant should be applied prior to fastening connectors to the busbar.
 16. All hardware (bolts, washers and nuts) that attaches to the SBB will be stainless steel.

C. RBB:

1. The RBB shall be installed horizontally or vertically on the rack using insulators which provide a minimum of 0.75 in separation.
2. The RBB shall be bonded to either the rack bonding conductor or to the Telecommunications Equipment Bonding Conductor and to the rack.
3. All the equipment within the rack or enclosure will be bonded to the RBB.
4. Any shielded products that enter the rack or enclosure will be bonded to the RBB.
5. The busbar shall be cleaned, and a compatible antioxidant should be applied prior to fastening connectors to the busbar.
6. All hardware (bolts, washers and nuts) that attaches to the RBB will be stainless steel.

3.3 INSTALLATION OF TBC (TELECOMMUNICATIONS BONDING CONDUCTOR):

- A. Shall be done by licensed electrician.
- B. Shall be sized to the largest cable used in the bonding system.
- C. Grounding cable runs from the Electrical Distribution Panel to the PBB.

3.4 INSTALLATION OF THE TBB (TELECOMMUNICATION BACKBONE):

- A. Determine the length from the PBB to the farthest SBB. You may have multiple risers, with varying lengths.
- B. Multiple TBBs are permitted.
- C. Use the table and size the conductor for each TBB (Table 1).
- D. Run the grounding cable from the PBB to the farthest SBB on an individual run. Terminate both sides with a lug and attach to the busbars.
- E. At each level, where there is a busbar along that length: use c-tap or h-tap to join a cable to the TBB (of equal size of the TBB) and run to the SBB. Terminate a lug on the end and attach to the SBB.
- F. TBB conductors shall be protected from physical and mechanical damage. All joints shall be adequately supported and protected from damage.
- G. The TBB conductors should be installed without splices, however, where splices are necessary, the number of splices should be minimized.
- H. Splices shall be accessible and be located in telecommunication rooms. Joined segments of a TBB shall be joined by means of a listed exothermic weld, listed irreversible compression-type connectors, or equivalent.
- I. Metallic cable shield(s), concrete reinforced steel, water pipe or any metal pathway for cable (e.g., conduit) shall not be used as a TBB.
- J. Structural metal is bonded to the building's grounding electrode system it may be used in place of a TBB.
 1. Before utilizing structural metal in place of a TBB, ensure the structural metal is electrically continuous or can be made so.
 2. A two-point continuity test should be performed on the structural metal to verify electrical continuity and acceptable resistance along

TABLE 1 TBB/GE - LENGTH TABLE	
Linear Length ft.	Size (AWG)
Less than 13	6
14 - 20	4
21 - 26	3
27 - 33	2
34 - 41	1
42 - 52	1/0
53 - 66	2/0
67 - 84	3/0
85 - 105	4/0
106 - 125	250 kcmil
126 - 150	300 kcmil
151 - 175	350 kcmil
176 - 250	500 kcmil
251 - 300	600 kcmil
301+	750 kcmil

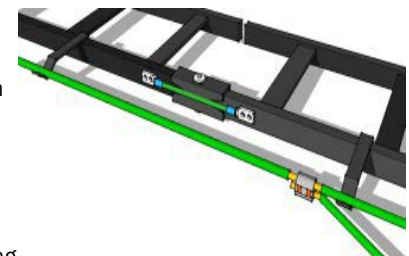

the paths used as bonding conductors.

- K. Concrete reinforcing steel shall not be used as a TBB or aBBC.

3.5 INSTALLATION OF THE TEBC (TELECOMMUNICATIONS EQUIPMENT BONDING CONDUCTOR):

- A. The TEBC connects the PBB/SBB to the RBB in the equipment racks/cabinets.
- B. More than one TEBC may be installed.
 - 1. The TEBC shall be a continuous copper conductor that is sized not less than a 6 AWG or as the largest size equipment grounding conductor in the ac branch power circuit(s).
 - 2. Cable will be run from the SBB to the farthest rack or cabinet in the row.
 - a) The TEBC will be terminated, with a listed irreversible crimp style two-hole long barrel lug, to the RBB.
- C. Cable shields, metal conduits, cable runways or ladders, or any other metallic cable pathways do not satisfy the requirements for a TEBC.
- D. The TEBCs will be routed on the outside of ladder rack or cable tray.
 - 1. Supported at 3-foot intervals.
- E. An alternative method to running TEBCs overhead is to route them under an access floor.
- F. TEBCs shall be separated a minimum of 2 inches from conductors of other cable groups such as power or telecommunications cables.
 - 1. An exception may be when conductors are grouped together to enter or exit a cabinet or enclosure. Grouping only at this point is acceptable, provided the conductors are suitably separated on either side of the opening.
- G. TEBCs shall be separated from ferrous material by a distance of at least 2 inches.

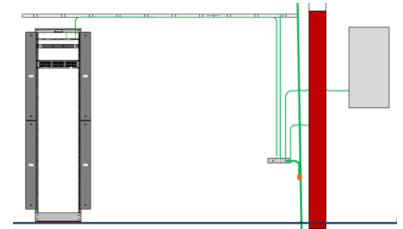

3.6 INSTALLATION OF THE RBB:

- A. The RBB shall be attached to the TEBC.
- B. The RBB shall be mounted horizontally or vertically to the equipment rack or cabinet.
- C. The busbar shall be cleaned, and an antioxidant should be applied prior to fastening connectors to the busbar. The antioxidant will be cleaned off after the bolts are tightened.
- D. All hardware (bolts, washers and nuts) that attaches to the RBB will be stainless steel.
- E. The rack or enclosure will be bonded to the RBB.
- F. All electronic equipment will be bonded to the RBB.
- G. All doors and side panels will be bonded with a bonding jumper.
 - 1. The jumper shall be a minimum sized conductor of #12 AWG stranded, high strand count, insulated copper conductor with green or green with yellow stripe jacket.
 - 2. The bonding jumper should have a solderless quick connect to facilitate detaching and attaching the panel or door.

3.7 BONDING LADDER RACK OR CABLE TRAY:

- A. Ladder rack or cable tray will be bonded from the PBB/SBB.
- B. Joints will be bonded with a 9-inch strap. A 2-hole long barrel lug will attach the strap to the ladder rack / cable tray.
- C. The paint or finish shall be removed prior to termination to the ladder rack or cable tray and an antioxidant should be applied prior to fastening connectors to the busbar. The antioxidant will be cleaned off after the bolts are tightened.

3.8 ARMORED FIBER OPTIC CABLES:

- A. All armored fiber optic cables will be bonded per NEC 700.100.

3.9 TESTING:

- A. Prior to two-point ground testing, a visual inspection shall be performed to verify that the bonding system is installed according to the guidelines of ANSI/TIA-607C.
- B. Due to the possibilities of ground faults traveling through the telecommunications bonding system, a voltage test should be performed prior to conducting the two-point continuity test and verified with the test equipment manufacturer's instructions.
- C. Testing requirements require a Two-point ground/continuity testing:
 - 1. Helps to determine if there is an acceptable level of resistance between any point in the telecommunications bonding system and the building's electrical grounding electrode system.
 - 2. The test is performed using an earth ground resistance tester that is configured for a continuity test, otherwise known as a two-point test or a "dead earth" test.
 - 3. The test is typically performed by connecting one test lead to the nearest building's electrical grounding electrode and the other test lead to a specific point on the telecommunications bonding system such as the PBB. This same test can also verify continuity between any two points of the telecommunications bonding system such as between the PBB and a SBB.
 - 4. It is recommended that this test be performed in the following areas:
 - a) PBB/SBB to the electrical ground in Telecommunications Distributors Room
 - b) PBB/SBB to the structural metal (if present)
 - c) PBB to SBB
 - d) Structural metal (if present) to the electrical ground.
- D. Consult with other contractors to ensure other electrical work does not interfere with this test.
- E. In order for this test to be valid it should be done before the telecommunications equipment is installed otherwise parallel paths may invalidate test results.
- F. The recommended maximum value for resistance between any point in the telecommunications bonding system and the building's electrical grounding electrode system is 100 milliohms.

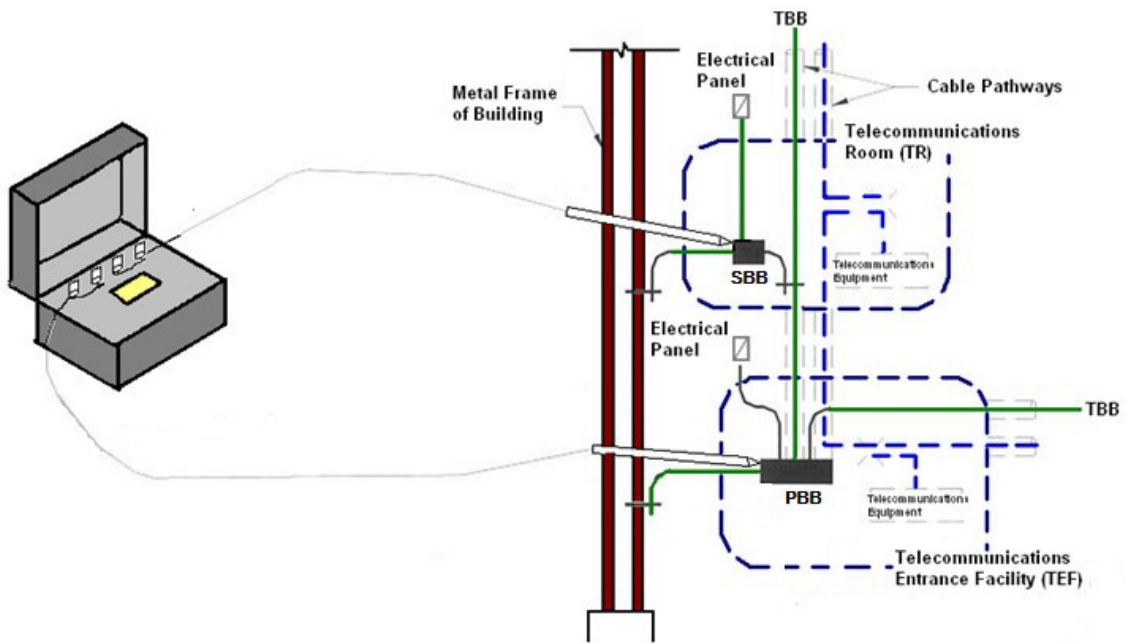

3.10 ADMINISTRATION:

- A. Each telecommunications bonding conductor shall be labeled at its points of termination.
- B. Labels shall be located on conductors as close as practical to their points of termination in a readable position.

IF THIS CONNECTOR OR CABLE IS LOOSE OR MUST BE REMOVED, PLEASE CALL THE BUILDING TELECOMMUNICATIONS MANAGER

END OF SECTION 27 05 26

[REMAINDER OF PAGE INTENTIONALLY LEFT BLANK]

PATHWAYS FOR COMMUNICATIONS SYSTEMS

PART 1 GENERAL:

1.1 INTRODUCTION:

A. Telecommunications Space Overview:

1. The design of spaces to house telecommunication cabling and equipment shall be in accordance with the ANSI/TIA-569-D: Commercial Building Standard for Telecommunication pathways and spaces and addenda to this standard.
2. This section covers the design and installation of telecommunications:
 - a) Spaces:
 - 1) Entrance facilities
 - 2) Telecommunications rooms and enclosures
 - 3) Pull boxes
 - 4) Floor boxes and poke throughs
 - b) Pathways:
 - 1) Ladder rack
 - 2) Cable tray
 - 3) Conduit
 - 4) J-hooks
 - 5) Inner duct
 - 6) Mechanical Fire Stopping Devices
3. The following communications Specifications are requirements for all School District of Osceola County (SDOC) projects. Request for deviations from these guides and requirements must be made in writing to the School District of Osceola County

1.2 RELATED DOCUMENTS:

A. Division 27 Sections that apply to this Section are:

1. Section 27 00 00 Communications
2. Section 27 05 26 Grounding & Bonding for Communications Systems
3. Section 27 05 36 Cable Trays for Communications Systems
4. Section 27 11 10 Telecommunications Spaces, Equipment and Fittings
5. Section 27 13 13 Communications Copper Backbone Cabling
6. Section 27 13 23 Communications Optical Fiber Backbone Cabling
7. Section 27 15 13 Communications Copper Horizontal Cabling
8. Section 27 15 43 Communications Faceplates and Modules
9. Section 27 16 19 Communications Patch Cords and Station Cords
10. Section 27 21 33 Wireless Access Point System
11. Section 27 41 16 Classroom Amplification System
12. Section 27 51 23 Educational Intercom and Program Clock System
13. Section 27 53 21 Distributed Antenna System – Public Safety

1.3 STANDARDS AND CODES:

- A. Refer to other sections in Division 27 00 00 – Communications
- B. Refer to Division 01 – Reference Standards and General Conditions of the Contract.
- C. Complies with both ANSI/TIA-607-C and NEC Article 250. The most stringent rules apply.

1.4 APPROVED MANUFACTURERS:

- A. The manufacturer of the products and materials in this section, that School District of Osceola County is using as basis of design in this document, as required for construction of the cabling infrastructure per contract documents shall be:
 - 1. Chatsworth Products
 - 2. Hubbell Premise Wiring
- B. Product substitutions from other manufacturers shall require the approval of the Project Technology Designer (Project Electrical Engineer and Registered Communication Distribution Designer (RCDD)) and SDOC Technology Services Department Representative 10 business days prior to bid opening.

1.5 SUBMITTALS:

- A. Shop drawings:
 - 1. Shop drawings will indicate the location of cable routes, bundle sizes, and penetrations (including cable trays, mechanical firestopping devices, and interior / exterior sleeving), and will require the approval of the Project Technology Designer (Project Electrical Engineer and Registered Communication Distribution Designer (RCDD)) and SDOC Technology Services Department Representative prior to implementation.
- B. Submit Manufacturer's Cut Sheets for the following (Refer to Section 27 00 00 – Communications Submittal):
 - 1. Major items not included in the Product Section.
 - 2. Submit for approval in accordance with specified submittal procedures:
 - a) Ladder racks
 - b) Cable trays
 - c) J-hooks
 - d) Pull boxes
 - e) Ceiling or zone enclosures
 - f) Floor boxes, poke through and accessories
 - g) Mechanical Firestopping Devices

1.6 QUALITY ASSURANCE:

- A. Manufacturers:
 - 1. Firms regularly engaged in manufacture of the materials, called out for in this section, whose products have been in satisfactory use in similar service for not less than 3 years.
- B. The Contractor will install work in accordance with the latest School District of Osceola County Requirements, the latest BICSI Information Technology Systems Installation Methods Manual, Telecommunications Distribution Methods Manual, TIA/EIA Standard Commercial Building Telecommunications Cabling Standard, systems planning and design manual.
- C. The Contractor who is installing the materials and systems will be trained by the referenced manufacturer in the proper installation practices. The Contractor will have the proper tools and test equipment to ensure a good and proper installation.
- D. Installed UTP cabling systems, pathways and distribution facilities will adhere to manufacturer's instructions, contract drawings and specifications, and applicable codes, standards, and regulations.
- E. Installed UTP cabling systems and field test results will strictly adhere to requirements of ANSI/TIA-568-0.D, ANSI/TIA-568-1.D and ANSI/TIA/EIA-568-2.D.
- F. Where applicable, all equipment, components, accessories, and hardware will be UL listed for the intended purpose of the installation.

- G. All critical internal manufacturing operations for installed products will have documented in-process inspection and testing according to ISO9001.
- H. Installed products will be manufactured by an ISO9001 certified facility.
- I. Installed products will be free from defects in material or workmanship from the manufacturer and will be of the quality indicated.
- J. All methods of construction that are not specified in the contract documents will be subject to control and approval by the Project Technology Designer (RCDD) and SDOC Technology Services Department Representative.
- K. Installed products will be lot-traceable by date code.

1.7 DEFINITION:

- A. Not used

1.8 WARRANTIES:

- A. Refer to Section 27 00 00 for general details

1.9 MATERIALS:

- A. All materials shall be UL or ETL listed and verified and shall be marked as such.
- B. Products shall be regularly catalogued items of the manufacturer and shall be supplied as a complete unit in accordance with the manufacturer's standard specifications with any optional items required for proper installation unless otherwise noted.
 - 1. All materials used on this project shall be new. Used and refurbished equipment are not permitted. Provided equipment on site in original packaging whenever practical.

1.10 DELIVERY, STORAGE AND HANDLING LOGISTICS:

- A. Material shall be delivered to the site in the original packing.
- B. Materials delivered to the construction site shall be stored in a dry, secure area, preferably indoors. Storage temperature of materials shall adhere to manufacturer's recommendations. Movement of packaged materials shall be in a manner to avoid damage of contents. On-site storage, either indoors or trailer, shall have permission by the School District of Osceola County Staff, and shall not interfere with other construction activity.
- C. Installation of Category 5e, Category 6 or Category 6a cable shall be within the recommended temperature range specified by the manufacturer. Cable installation temperature range between 50°F and 80°F is recommended. Cabling should only be installed in facilities that are not exposed to the elements.
- D. The Contractor is responsible for scheduling all deliveries and providing proper receipt, handling, and storage of all materials. Protect all equipment from physical damages (dents, scratches, dust, water, **paint**, chemicals, and temperature extremes) and vandalism, or theft. The Contractor shall replace any damaged or stolen equipment. The Contractor is responsible for all equipment until final project acceptance by the School District of Osceola County.
- E. The Contractor is responsible for cleaning the worksite every business day and removing debris from the facility.

1.11 COORDINATION WITH OTHER TRADES:

- A. Coordinate layout of work with other trades. Make minor adjustments in locations required for coordination. Locations of structural systems, heating work and plumbing lines shall take preference over locations of conduit lines where conflict occurs. Structural systems, heating work, and plumbing lines shall not interfere with or otherwise impede the routing of communication cabling with cable tray, raceways, or other pathways dedicated to communications. All potential issues shall be brought to the attention of the General Contractor, Construction Manager, Architect, Engineer, Project Technology Designer (RCDD), The School District of Osceola County and SDOC Technology Services Department Representative immediately before proceeding with installation.
- B. Other than minor issues, adjustments shall be submitted to the General Contractor, Construction Manager, Architect, Engineer, Project Technology Designer (RCDD), and SDOC Technology Services Department Representative for approval before proceeding with the work.

- C. Coordinate locations, arrangement, mounting, and support of all communications provisions with Division 26 Representative, Project Technology Designer (RCDD), and SDOC Technology Services Department Representative that:
 - 1. Allow maximum possible headroom unless specific mounting heights that reduce headroom are indicated
 - 2. Provide for ease of disconnecting the equipment with minimum interference to other installations
 - 3. Allow right of way for piping and conduit installed at required slope
 - 4. Coordinate that raceways, cables, and cable trays will be clear of obstructions and of the working and access space of other equipment
 - 5. Coordinate installation of required supporting devices and set sleeves in cast-in-place concrete, masonry walls, and other structural components as they are constructed
 - 6. Coordinate sleeve selection specified in Division 07 and Division 26
 - 7. Coordinate location of access panels and doors for electrical items that are behind finished surfaces or otherwise concealed
 - 8. Coordinate the gauge cables to be used in the telecommunications grounding system
- D. Low Voltage Contractor shall furnish and install the following:
 - 1. Ladder racks
 - 2. Cable trays
 - 3. J-hooks
 - 4. Ceiling or zone enclosures
- E. Electrical Contractor shall furnish and install the following:
 - 1. Conduit
 - 2. Outlet Boxes
 - 3. Penetrations
 - 4. Mechanical Firestop devices
 - 5. Sleeving (rated / non-rated barriers)
- F. Unless noted otherwise, the following items will be the responsibility of the School District of Osceola County:
 - 1. All electronics and active data networking equipment, etc.
 - 2. Telephones, etc.
 - 3. PC's, printers, video display terminals (desktop), flat panel displays (desktop), etc.

PART 2 PRODUCTS:

2.1 LADDER RACK:

- A. Ladder rack is the effective and widely used cable runway that supports and delivers bundles of cable between cabinets, racks, closets, along walls, and suspended from ceilings.
- B. The ladder rack system features light, rugged, tubular steel construction. It is designed for mechanical support and strain relief in long runs of cable and creates a smooth gradual bend for cable.
- C. Ladder rack shall be manufactured from 16 GA Tubular steel.
 - 1. Stringers will be made from 3/8" wide by 1-1/2" high tubular steel.
 - 2. Cross members will be made from 1" wide by 1/2" high tubular steel.
 - 3. Cross members will be welded in between stringers on 9" centers.
- D. The ladder rack is available in gray and black finishes.
- E. The ladder rack system features a broad line of sizes and fittings required for proper installation.
- F. Available in 6", 12", 18" and 24" widths.

2.2 CABLE TRAY – WIRE MESH

- A. Clean and attractive pre-galvanized steel finish
- B. No post-production chemical cleaning and plating. All surfaces are to be free of zinc whiskers, oils, solvents, and soot from welding operation.
- C. All wire trays are UL classified and can be used in grounding.
- D. Available for overhead or under-floor applications
- E. 100% recycled steel content
- F. The wire basket cable tray systems provide superior cable management and protection for data communications cabling.
- G. The wire basket cable tray system features a broad line of sizes and fittings required for proper installation.
- H. Layouts, installations, and changes are quickly and easily configured to requirements with wire cutting tools. Basket tray installs faster than conduit systems and offers more flexibility and capacity.
- I. Individual tray sections shall be 10 ft. long.
- J. The cable tray system is available in 4", 6", 8", 12", 16", 18", 20" or 24" widths.
- K. The cable tray system sidewalls are available with 2", 4" or 6" heights.

2.3 J-HOOKS:

- A. The J-Hooks will have a wide base design and smooth beveled edges to provide a large bending radius for current and future high-performance data cables and fiber optics.
- B. J-Hooks offer a solution that meets industry standards for Category 6A and easily accommodates large-diameter fiber optic, innerduct and coax cable.
- C. The J-Hooks are designed to provide a strong and stable pathway support installation.
- D. Provides optimal support for high-performance data cable, up to and including Category 5e, Category 6, Category 6A, and fiber optic cables.
- E. Rounded edges on J-Hooks provide proper bend radius support for high performance data cables.
- F. Multiple color options aid in the identification and organization of the pathway application.
- G. Provides superior fill capacity and load rating over most other non-continuous cable support alternatives:
 - 1. Category 5e 50 Cables
 - 2. Category 6 35 Cables
 - 3. Category 6A 25 Cables
- H. Compliant with UL® 2043 and suitable for use in air handling (plenum) spaces.
- I. J-hooks do not require to be grounded.
- J. Meets ISO®/IEC 14763-2, ANSI/TIA 568 and ANSI/TIA 569

2.4 CONDUIT SYSTEMS:

- A. Conduit:
 - 1. Galvanized rigid conduit (GRC):
 - 2. Intermediate metallic conduit (IMC):
 - 3. Electrical Metallic Tubing (EMT)
- B. Datacom/AV/Electrical box:
 - 1. Gangable Wall Boxes are a solution for in wall applications requiring AV, data, and power integration.
 - 2. Concentric 1"- 2" knockouts combined with a 4-inch depth facilitates easy installation of telecommunication cables incorporating pre-connectorized heads and bend radius required for high performance Category 6 and 6A cables.
 - 3. Designed to be installed independently or ganged together to receive any number of devices, allowing them to accept any standard wall plate.

4. The Gangable Wall Boxes have a built-in adjustable sheetrock locating bracket to adjust to the depth of the sheetrock.
5. The Gangable Wall Boxes can be installed in 2, 3, 4, 5, 6 gang applications.
6. A ground screw available in each gang so that regardless of what services are brought into the box there is a means of grounding readily available.
7. The metallic low voltage partition is available to separate electrical from low voltage and can be use used to divide other low voltage applications.
8. A metallic low voltage partition is available for both boxes and is adjustable to accommodate any number of gangs.

PART 3 EXECUTION:

3.1 LADDER RACK:

A. Horizontal Ladder Rack:

1. Provide all components of the ladder rack system (ladder rack, turns, splices, supports, and accessories) from a single manufacturer.
2. Ladder rack shall be installed with side stringers facing down so that the ladder forms an inverted U-shape and so that welds between the stringers (sides) and cross members (middle) face away from cables.
3. Ladder rack shall be secured to the structural ceiling, building truss system, wall, floor or the tops of equipment racks and/or cabinets using the manufacturer's recommended supports and appropriate installation hardware and methods as defined by local code or the authority having jurisdiction (AHJ).
4. Ladder rack splices will be made in mid-span, not over a support, with the manufacturer's recommended splice hardware.
5. Install at 84" A.F.F. per manufacturer's recommendations and secured to the top of equipment racks.
6. Ladder rack shall be supported every 5' or less in accordance with TIA-569-D. Ladder rack shall be supported within 2' of every splice and within 2' on both / all sides of every intersection. Support ladder rack within 2' on both sides of every change in elevation. Support ladder rack every 2' when attached vertically to a wall.
7. When the pathway is overhead, ladder rack shall be installed with a minimum clearance of 12" above the ladder rack. Leave a minimum of 12" in between ladder rack and ceiling / building truss structure. Leave a minimum of 3" in between ladder rack and the tops of equipment racks and / or cabinets. Multiple tiers of ladder rack shall be installed with a minimum clearance of 12" in between each tier of ladder rack. When located above an acoustical drop ceiling, leave a minimum of 3" clearance between the top of the drop ceiling tiles and the bottom of the ladder rack.
8. Within each telecommunications room, ladder rack should be bonded together, electrically continuous, and bonded to the PBB or SBB, unless otherwise noted in the specifications and contract documents. Ladder rack and turns shall be bonded across each splice with a bonding kit. Ladder rack shall be bonded to the Telecommunication Bonding Busbar using an approved ground lug on the ladder rack and a minimum #6 AWG grounding wire or as recommended by the AHJ. Remove paint from the ladder rack where bonding/ground lugs contact the ladder rack so that the lug will contact bare metal. Use antioxidant joint compound in between the bare metal on the ladder rack and ground lug. Use antioxidant joint compound in between the bus bar and the ground lug. Verify continuity through the bonds at splices and intersections between individual ladder rack sections and turns and through the bond to the PBB or SBB.
9. The quantity of cables within the ladder rack will not exceed a whole number value equal to 50% of the interior area of the ladder rack divided by the cross-sectional area of the cable. The interior area of ladder rack will be considered to be the width of the ladder rack multiplied by a height of 2", unless cable retaining posts are added to the ladder rack. The interior area of ladder rack equipped with cable retaining posts will be considered to be the width of the ladder rack multiplied by a height of 6". Actual cable fill for ladder rack that is not equipped with cable retaining posts will not exceed 2" in height. Actual cable fill for ladder rack equipped with cable retaining posts will not exceed 6" in height.
10. The combined weight of cables within the ladder rack will not exceed the stated load capacity of the ladder rack as stated in the manufacturer's product specifications or load / design tables.

11. Cables (cable bundles) will be secured to the cross members of ladder rack with $\frac{3}{4}$ " wide reusable straps. Straps are not required when ladder rack is equipped with cable retaining posts.
 12. Add 8" high cable retaining posts to the open sides of ladder rack when cable fill exceeds 2" in height or when cable bundles cannot be secured directly to the ladder rack cross members with a strap. Cable fill within any ladder rack should not exceed 6" in height.
 13. When a single ladder rack supports different types of cable media, each type of cable media and divided area of the ladder rack separately when determining cable fill limits.
 14. Use a radius drop to guide cables wherever cable exits overhead ladder rack to access a rack, cabinet or wall-mounted rack and cabinet or termination field. Provide a moveable cross member also to attach and align the radius drop in between the welded cross members of a ladder rack.
 15. Cover the exposed ends of cable runway that do not terminate against a wall, the floor or the ceiling with end caps or an end closing kit.
 16. Whenever possible, maintain a 2' separation between ladder racks used for communications cables and pathways for other utilities or building services.
 17. The installer will provide touch-up paint color-matched to the finish on the ladder rack and will correct any minor cosmetic damage (chips, small scratches, etc.) resulting from normal handling during the installation process prior to delivery to the School District of Osceola County.
 18. If a component is cosmetically damaged to the extent that correction in the field is obvious against the factory finish, the component will be replaced with a new component finished from the factory. If a component is physically damaged due to mishandling or modification during the installation process, it shall not be used as part of the ladder rack system.
 19. The ladder rack shall be supported at three-foot intervals with triangular support brackets from the walls and securely attached to the equipment.
 20. Cable radius waterfalls shall be attached to the ladder rack to maintain cable bending radius where cables enter and exit the ladder rack.
 21. Cable shall be secured to the ladder rack using reusable Velcro® type cable wraps to arrange cables in logical bundles.
 22. Telecommunication grounding and bonding shall be in accordance with applicable codes, standards, and regulations. Comply with ANSI/TIA-607-C and the NEC. The more stringent requirements shall be used.
- B. Vertical Ladder Racks:
1. Vertical ladder rack shall be installed by the Contractor.
 2. The vertical ladder rack shall be installed on the wall above / below sleeves from the floor to the ceiling above. Stand offs shall be installed as necessary to support the required ladder rack.
 3. The anchoring system provided shall be suitable for the type of wall and the weight to be supported by the ladder rack.
 4. Cable shall be secured to the ladder rack using reusable Velcro® type cable wraps to arrange cables in logical bundles.

3.2 J-HOOKS:

- A. Do not space more than 60" apart
- B. Acceptable sag from the bottom of the j-hook is between 4" and 12"
- C. Do not exceed the recommended fill ratio of the j-hook. Consult the manufacturer.
- D. Provide Velcro® type wraps for the structured cabling.

3.3 WIRE MESH CABLE TRAY:

- A. Provide all components of the tray system (tray, supports, splices, fasteners, and accessories) from a single manufacturer.
- B. Wire mesh cable tray shall be secured to the structural ceiling, building truss system, wall or floor using manufacturer's recommended supports and appropriate hardware as defined by local code or the authority having jurisdiction(AHJ).

- C. When the pathway is overhead, wire mesh cable tray shall be installed with a minimum clearance of 12" above the tray. Leave 12" in between the tray and ceiling / building truss structure. Multiple tiers of wire mesh cable tray shall be installed with a minimum clearance of 12" in between the trays. When located above an acoustical drop ceiling, wire mesh cable tray shall be installed a minimum of 3" above the drop ceiling tiles.
- D. When installed under a raised floor, wire mesh cable tray shall be installed with a minimum 3/4" clearance between the top of the tray and the bottom of the floor tiles or floor system stringers, whichever are lower in elevation. Maintain a 3" clearance between trays wherever trays cross over.
- E. Wire mesh cable tray shall be supported every 6' of span or less. Support wire mesh cable tray within 2' of every splice and intersection. Support intersections on all sides. Support wire mesh cable tray on both sides of every change in elevation/direction. The weight of the load on the cable tray must not exceed the stated limits per span in the manufacturer's published load table. Use additional supports where needed.
- F. Secure wire mesh cable tray to each support with a minimum of one fastener. Follow the manufacturers' recommended assembly, splice, and intersection-forming practices.
- G. Use installation tools and practices recommended by the manufacturer to field fabricate wire mesh cable tray intersections and changes in elevation. Use side-action bolt cutters with an offset head to cut wire mesh cable tray.
- H. Wire mesh cable tray shall be bonded to the grounding busbar in the room (PBB or SBB) using an approved ground lug on the wire basket tray and a minimum #6 AWG grounding wire or as recommended by the AHJ. Follow UL classified splicing methods recommended by the manufacturer, ground the tray per NEC and ANSI/TIA-607-C requirements and verify bonds at splices and intersections between individual cable tray sections. Cable pathway should be electrically continuous through bonding and attached to the SBB or PBB.
- I. The quantity of cables within the tray will not exceed the recommended capacity by the manufacturer.
- J. The combined weight of cables within the tray will not exceed stated load capacity in manufacturer's specifications.
- K. Cable trays shall be utilized as main pathways entering or exiting CD (MDF) / FD (IDF) locations and shall be incorporated as pathways for cable bundles over twenty-five cables. No open top cable supports shall be used for cable bundles over twenty-five cables.
- L. Separate different media type within the tray. Treat each type of media separately when determining cable fill limits.
- M. When pathways for other utilities or building services are within 2' of the wire mesh cable tray, cover the tray after cables are installed.

3.4 FIRESTOPPING AND SEALING CONDUITS / TRAYS:

- A. Mechanical Fire Stop devices shall be used throughout the cabling installation (when applicable / feasible).
- B. The Telecommunication Contractor shall be responsible for sealing and firestopping of all penetrations and conduits used and un-used in the telecommunication system.
- C. The fire and smoke wall penetrations will be sealed promptly in all active walls so as not to diminish the level of life safety.
- D. Seal around conduits, sleeves and other wiring raceways passing through floors, fire rated walls, or partitions which extend to underside of the structure above in strict conformance with Project drawings.

3.5 CONDUIT SYSTEMS:

- A. Conduit and boxes: comply with requirements in Division 26 Section "Raceway and Boxes for Electrical Systems".
- B. All telecommunication conduits required for installation in the building floor slabs and above ceilings shall be furnished and installed by the electrical Contractor under Division 26 - Electrical. These conduits are to be routed as shown on the Division 27 - Telecommunication drawings.
- C. Installation costs are to include all necessary equipment for a turnkey job, such as hangers, fittings, set screw, connector ends, bushings, and color coding, as well as the repainting / cleanup of drywall area around each new outlet box. Also, it shall be the Contractor's responsibility to make and restore all firewall penetrations.
- D. Flexible metal conduit shall not be used.
- E. All station conduits shall be routed out of the box to the telecommunication Cable Tray, (under Division 26). Station conduits shall be 1-1/4" EMT conduit with bushing.

- F. Conduits fewer than 30 ft. in length do not require grounding (under Division 26).
- G. The Telecommunication Contractor will be responsible for fire stopping all the firewall penetrations or fire barriers; conduit wall sleeves, cable trays, riser sleeves, and conduits.
- H. All conduits shall be thoroughly cleaned before installation. During the construction process and after the duct line is complete; the ends of the conduits shall be plugged to prevent entry of any foreign matter. Particular care shall be taken to keep the conduits free of concrete or any other substance during the course of the construction process. Where it is necessary to cut the tapered end on a piece of conduit at the site, the cut shall be made with a tool or lathe designed for that specific purpose. After the duct line has been completed, a mandrel, not less than twelve inches (12") long, having a cross section of approximately one-quarter inch (1/4") less than the inside cross section of the conduit, shall be pulled through each conduit. Afterward, a brush with stiff bristles and swabs shall be pulled through the conduit to make certain that no foreign materials have entered.
- I. The Contractor shall install pull cords in each conduit. The Contractor shall install a polyolefin pull line, of two hundred pound (200lbs) Tensile Strength, in each conduit (under Division 26).
- J. Galvanized rigid steel (GRC) or intermediate grade steel conduit (IMC): use for 1-1/4" diameter and larger; for circuit's exposed to weather or moisture; in hazardous locations; run underground or in concrete. Terminate with double locknuts and OZ type BLG grounding type bushing in dry locations and watertight hubs in Wet locations. Join with threaded fittings. Do not use split fittings underground.
- K. Electrical metallic tubing (EMT): use in dry locations only; use for branch Circuits; auxiliary and control circuit's; telephone circuits. Join and terminate with rain-tight compression insulated throat fittings except auxiliary, control and Telephone circuit's 1-1/4" diameter and larger use all-steel setscrew insulated throat Fittings.
- L. Liquid-tight flexible steel conduit (LT) shall have the same construction as flexible steel conduit above, except with PVC coating by anaconda (Sealtite). Use in Exterior and wet locations for final connections to vibrating equipment. Terminate With galvanized steel compression fittings approved for grounding.
- M. PVC conduit shall be PVC as required by local codes. Connections shall be fully bonded and sealed, using approved epoxy cement.
- N. All conduits are to be placed above and below the lay-in ceilings as required for the type Systems and must be supported from the overhead with Unistrut and supported to wall structure.
- O. Conduit supports: use approved straps, rods, hangers, and trapeze channels. Conduit shall not be supported with wire or perforated straps.
- P. The conduit installation work is to comply with the latest edition of the National Electrical Code, national electrical safety code, standard building code, local ordinances and other standards indicated herein.
- Q. Electrical pull box covers must be labeled with the name of the feeder source and the feeder load.
- R. The labeling must be done in painted stencil letters. These conduits shall be installed as indicated on the construction drawings and to the School District of Osceola County / architect's satisfaction.
- S. Support all boxes from structure. Support outlet boxes in metal stud walls with caddy type h metal supports. Locate adjacent power, telephone and data telecommunication outlets side by side in the same electrical box.
- T. Electrical and data portions of the box will be separated by a divider. The box and divider will be bonded to an approved ground.
- U. Thread-less rigid or intermediate grade fittings shall not be used. Fittings must be steel or malleable bushings shall be iron, galvanized, with smooth 1050-rated phenolic ring with grounding lug where required.
- V. Electrical metallic tubing, thread-less type connectors and couplings, etc., use galvanized steel, concrete tight, insulated throat, set screw type conduit system.
- W. Connectors for flexible steel conduit shall be UL approved for grounding, galvanized steel, thread-less type, with insulatedthroat.
- X. Where ground conductor is installed in conduit 1¼" and larger, provide insulated ground bushings and bond full size ground wire from bushings to box or cabinet with self-tapping screw and appropriate lug.
- Y. Conduit penetrations through roof shall be made in pipe flashings / seal approved by SDOC Representative / architect and shall be located adjacent to the equipment served.
- Z. Conduits for telecommunications backbone cabling (between telecom rooms, vaults, and buildings) shall have two (2) detectable tree (3) cell fabric innerduct installed in each conduit.

END OF SECTION 27 05 28

SECTION 27 05 36

CABLE TRAYS FOR COMMUNICATIONS SYSTEMS

PART 1 GENERAL:

1.1 INTRODUCTION:

A. Telecommunication Cable Tray:

1. The work covered by this section of the Specifications includes all labor necessary to perform and complete such construction, all materials and equipment incorporated or to be incorporated in such construction and all services, facilities, tools and equipment necessary or used to perform and complete such construction.
 - a) Telecommunications cable trays and accessories in accordance with the strictest manufacturer written recommendation per code or the best industry practice. These following communication Specifications are requirements for all School District of Osceola County (SDOC) projects. Request for deviations from these guides and requirements must be made in writing to the School Board of Osceola County.

1.2 RELATED DOCUMENTS:

A. Division 27 Sections that apply to this Section are:

1. Section 27 00 00 Communications
2. Section 27 05 26 Grounding & Bonding for Communications Systems
3. Section 27 05 28 Pathways for Communications Systems
4. Section 27 11 10 Telecommunications Spaces, Equipment and Fittings
5. Section 27 13 13 Communications Copper Backbone Cabling
6. Section 27 13 23 Communications Optical Fiber Backbone Cabling
7. Section 27 15 13 Communications Copper Horizontal Cabling
8. Section 27 15 43 Communications Faceplates and Modules
9. Section 27 16 19 Communications Patch Cords and Station Cords
10. Section 27 21 33 Wireless Access Point System
11. Section 27 41 16 Classroom Amplification System
12. Section 27 51 23 Educational Intercom and Program Clock System
13. Section 27 53 21 Distributed Antenna System – Public Safety

1.3 STANDARDS AND CODES:

- A. Refer to other sections in Division 27 00 00 – Communications
- B. Refer to Division 01 – Reference Standards and General Conditions of the Contract
- C. Complies with the following:
 1. ASTM B 633 – Specification for Electrodeposited Coatings of Zinc on Iron and Steel
 2. ASTM A 653 – Specification for Steel Sheet, Zinc-Coated (Galvanized) by the Hot Dip Process
 3. ASTM A 123 – Specification for Zinc (Hot Galvanized) Coatings on Iron and Steel
 4. ASTM A 510 – Specification for General Requirements for Wire Rods and Coarse Round Wire, Carbon Steel
 5. NEMA VE 1-2018 – Metal Cable Tray Systems
 6. NEMA VE 2-2018 – Cable Tray Installation Guidelines
 7. ASTM A 641 – Standard Specification for Zinc-Coated (Galvanized) Carbon Steel Wire
 8. ASTM A 580 – Standard Specification for Stainless Steel Wire

9. ASTM D 769 – Standard Specification for Black Oxide Coatings

1.4 APPROVED PRODUCT MANUFACTURERS:

- A. The manufacturer of the materials in this section, that School District of Osceola County is using as basis of design in this document, as required for construction of the cabling infrastructure per contract documents shall be:
 - 1. Hubbell Premise Wiring
- B. Product substitutions from other manufacturers shall require the approval of the Project Technology Designer (Project Electrical Engineer and Registered Communication Distribution Designer (RCDD)) and SDOC Technology Services Department Representative 10 business days prior to bid opening.

1.5 SUBMITTALS:

- A. Shop Drawings:
 - 1. Shop drawings will indicate the location of cable routes, bundle sizes, and penetrations (including cable trays, mechanical firestops, and interior / exterior sleeving), and will require the approval of the Project Technology Designer (Project Electrical Engineer and Registered Communication Distribution Designer (RCDD)) and SDOC Technology Services Department Representative prior to implementation.
- B. Submit Manufacturer's Cut Sheets for the following (Refer to Section 27 00 00 – Communications Submittal):
 - 1. Major items not included in the Product Section
 - 2. Submit for approval in accordance with specified submittal procedures:
 - a) Wire / Cable Trays
 - b) Cable Tray Accessories

1.6 QUALITY ASSURANCE:

- A. Manufacturer:
 - 1. Firms regularly engaged in manufacture of the materials, called out for in this section, whose products have been in satisfactory use in similar service for not less than 3 years.
- B. The Contractor will install work in accordance with the latest School District of Osceola County Requirements, the latest BICSI Information Technology Systems Installation Methods Manual, Telecommunications Distribution Methods Manual, TIA/EIA Standard Commercial Building Telecommunications Cabling Standard, systems planning and design manual.
- C. The Contractor who is installing the materials and systems will be trained by the referenced manufacturer in the proper installation practices. The Contractor will have the proper tools and test equipment to ensure a good and proper installation.
- D. Installed UTP cabling systems, pathways and distribution facilities will adhere to manufacturer's instructions, contract drawings and specifications, and applicable codes, standards, and regulations.
- E. Installed UTP cabling systems and field test results will strictly adhere to requirements of ANSI/TIA-568-0.D, ANSI/TIA-568-1.D and ANSI/TIA/EIA-568-2.D.
- F. Where applicable, all equipment, components, accessories, and hardware will be UL listed for the intended purpose of the installation.
- G. All critical internal manufacturing operations for installed products will have documented in-process inspection and testing according to ISO9001.
- H. Installed products will be manufactured by an ISO9001 certified facility.
- I. Installed products will be free from defects in material or workmanship from the manufacturer and will be of the quality indicated.
- J. All methods of construction that are not specified in the contract documents will be subject to control and approval by the Project Technology Designer (RCDD) and SDOC Technology Services Department Representative.
- K. Installed products will be lot-traceable by date code.

PART 2 PRODUCTS:

2.1 WIRE TRAY:

- A. Provide wire basket of types and sizes indicated, with all required splicing and mounting hardware.
- B. Pre-Galvanized Zinc: Straight section shall be made from pre-galvanized steel meeting the minimum mechanical properties of ASTM A641.
- C. All straight section longitudinal wires shall be constructed with a continuous top wire safety edge. Safety edge must be T-welded on all tray sizes.
- D. Wire basket shall be made of high strength steel wires and formed into a standard 2 inch by 4-inch wire mesh pattern with intersecting wires welded together. All mesh sections must have at least one bottom longitudinal wire along entire length of straight section.
- E. Straight sections shall be furnished in standard 118-inch lengths.
- F. Wire basket shall have 4 inches usable loading depth by 24 inches wide.
- G. When multiple mediums are used in the same tray, a divider must be used for separation. The dividers must be grounded.
- H. All fittings shall be field formed, from straight sections, in accordance with the manufacturer's instructions.
- I. All Tray sections and splicing assemblies shall be UL Classified as an Equipment Ground Conductor (EGC).

2.2 CABLE TRAY ACCESSORIES:

- A. Fittings: Tees, crosses, risers, elbows, and other fittings should be of the same materials and finishes as cable tray, and from the same manufacturer.
- B. Cable tray supports and connectors including bonding jumpers, as required by cable tray manufacturer.
- C. Cable tray fittings that are used for changing of direction or elevation shall be factory made expressly for that purpose. No field improvised fittings are to be used.

PART 3 EXECUTION:

3.1 GENERAL:

- A. Coordinate location of cable trays with other trades to avoid conflicts and maintain accessibility.
- B. Wire baskets / cable trays shall be utilized where cable bundles exceed twenty-five cables and as main pathways exiting / entering CD (MDF) / FD (IDF) locations.
- C. Quantities of cable trays and associated accessories shown on the drawings are illustrative only and are meant to indicate the general configuration of the work. The Contractor is responsible for providing the correct quantities of materials to construct a system that meets the intent of these Specifications and the relevant codes.
- D. Where installed above an accessible ceiling, cable trays shall be not less than 12 inches above the bottom of the finished ceiling.
- E. Vertical clearance above the tray shall be a minimum of 12 inches; clearance to at least one side of the cable tray shall be not less than 3 feet.
- F. Conduit entries and all other transition points shall occur only in accessible locations.
- G. Install wire basket as indicated; in accordance with recognized industry practices (NEMA VE-2 2018), to ensure that the cable tray equipment complies with requirements of NEC, and applicable portions of NFPA 70B and NECA's "Standards of Installation" pertaining to general electrical installation practices.
- H. Coordinate wire basket with other electrical work as necessary to properly interface installation of wire basket runway with other work.
- I. Provide required space encompassing wire basket to permit access for installing and maintaining cables.

3.2 INSTALLATION:

- A. Cable tray shall be one continuous structure, and installed level.
- B. All transitions shall use radius fittings.
- C. Install cable tray so that it is accessible:
 - 1. Installation in open ceiling areas and above lay-in accessible ceilings is generally acceptable.

2. Installation above "hard" ceilings, within a chase, behind a wall or where obstructed by ducts, pipes, etc. is not acceptable.
- D. Where the cable tray crosses an inaccessible area, place a minimum of four 4" conduits, with reamed and bushed ends, to connect the accessible segments together. The 4" conduits must extend beyond the edge of the inaccessible area on both sides.
 1. Exception: Relatively short (10 foot maximum) straight sections (no transitions) of cable tray may be routed over hard ceilings or through similar inaccessible areas provided that good access to the cable tray is maintained at both ends of the short inaccessible run.
 - E. Where conduits are used in lieu of a section of cable tray, they must join the cable tray from the end at an equal height, not from the side or above. Transitions of this type require the use of a Straight Reducer Fitting.
 - F. Install expansion joints and related fittings where required to accommodate the expected environmental ambient temperature range of 50° to 80°F.
 - G. Each end of the tray shall be equipped with a finished lip and drop off to reduce damage to cables.
 - H. Manufactured offsets shall be used to change height or direction of rigid cable trays. Cable tray vertical transitions or transitions from a cable tray to other pathways must be designed such that unsupported cable does not exceed 2 feet.
 - I. Cable tray offsets shall utilize 30-degree angles, and distance between transitions shall be no less than two times the offset distance.
 - J. Cable trays shall be clean and free of debris before the placement of cable.
 - K. Firestopping:
 1. Where cable tray encounters a fire rated assembly (wall, floor, shaft, etc.), install a listed mechanical fire stop system to maintain the fire rating of the assembly. Firestop systems must be of a re-enterable type EZ Path mechanical Fire Rated pathway.
 2. All firestop systems must be accessible for future maintenance.
 - L. Support:
 1. Supports shall be 3/8" threaded rod trapeze style hangers, threaded rods with rail clips as recommended by the cable tray manufacturer and as suitable for the specified cable tray NEMA Load / Span Designation.
 2. Side rails shall bear on the supports; rungs shall not bear on the supports.
 3. Cable tray supports shall not be used to mount any other structures.

3.3 GROUNDING & BONDING:

- A. Cable tray shall be electrically continuous. Where a cable tray run is interrupted at a fire rated assembly, an expansion joint or is otherwise rendered electrically discontinuous, provide bonding jumpers.
- B. Where cable tray enters a telecommunication or equipment room, bond the cable tray to the TGB in that room.
- C. Where conduits or other conductive raceways connect to a cable tray system, bond them together with connection suitable for the purpose.
- D. Refer to Section 27 05 26 for additional details.

3.4 TESTING:

- A. Test wire basket support systems to ensure electrical continuity of bonding and grounding connections, and to demonstrate compliance with specified maximum grounding resistance. See NFPA 70B, Chapter 11, for testing and test methods.

3.5 ACCEPTANCE:

- A. Once the installation and testing of all pathways have been completed and the Project Technology Designer (Electrical Engineer and Registered Communications Distribution Designer (RCDD)) and SDOC Technology Services Department Representative are satisfied that all work is in accordance with the Contract Documents, the Technology Designer (RCDD) will notify the School District of Osceola County (SDOC) Project Manager in writing or via email of acceptance.
- B. No cables shall be installed in the cable trays until School District of Osceola County Technology Services Department Representative has given acceptance.

END OF SECTION 27 05 36
[REMAINDER OF PAGE INTENTIONALLY LEFT BLANK]

SECTION 27 11 10

TELECOMMUNICATIONS SPACES, EQUIPMENT, AND FITTINGS

PART 1 GENERAL:

1.1 INTRODUCTION:

A. Telecommunications Spaces:

1. The work covered by this section of the Specifications includes all labor necessary to perform and complete such construction, all materials and equipment incorporated or to be incorporated in such construction and all services, facilities, tools, and equipment necessary or used to perform and complete such construction. The work of this section shall include, but is not limited to, the following:

- B. Telecommunication rooms, spaces, locations, and accessories in accordance with the strictest manufacturer written recommendation per code or the best industry practice. These following communication Specifications are requirements for all School District of Osceola County (SDOC) projects. Request for deviations from these guides and requirements must be made in writing to the School Board of Osceola County.

1.2 RELATED DOCUMENTS:

A. Division 27 Sections that apply to this Section are:

1. Section 27 00 00 Communications
2. Section 27 05 26 Grounding & Bonding for Communications Systems
3. Section 27 05 28 Pathways for Communications Systems
4. Section 27 05 36 Cable Trays for Communications Systems
5. Section 27 13 13 Communications Copper Backbone Cabling
6. Section 27 13 23 Communications Optical Fiber Backbone Cabling
7. Section 27 15 13 Communications Copper Horizontal Cabling
8. Section 27 15 43 Communications Faceplates and Modules
9. Section 27 16 19 Communications Patch Cords and Station Cords
10. Section 27 21 33 Wireless Access Point System
11. Section 27 41 16 Classroom Amplification System
12. Section 27 51 23 Educational Intercom and Program Clock System
13. Section 27 53 21 Distributed Antenna System – Public Safety

1.3 STANDARDS AND CODES:

- A. Refer to other Sections in Division 27 00 00 – Communications
- B. Refer to Division 01 – Reference Standards and General Conditions of the Contract.
- C. Complies with both ANSI/TIA-607-C and NEC Article 250. The most stringent rules apply.

1.4 APPROVED PRODUCT MANUFACTURERS:

- A. The manufacturer of the products and materials in this section, that School District of Osceola County is using as basis of design in this document, as required for construction of the cabling infrastructure per contract documents shall be:
 1. Hubbell Premise Wiring
 2. ReadySPEC Backboards
 3. Chatsworth Products

- B. Product substitutions from other manufacturers shall require the approval of the Project Technology Designer (Project Electrical Engineer and Registered Communication Distribution Designer (RCDD)) and SDOC Technology Services Department Representative 10 business days prior to bid opening.

1.5 SUBMITTALS:

- A. Shop Drawings:
 - 1. Shop drawing will indicate the location of cable routes, bundle sizes, and penetrations (including cable trays, mechanical firestops, and interior / exterior sleeving), and will require the approval of the Project Technology Designer (Project Electrical Engineer and Registered Communication Distribution Designer (RCDD)) and SDOC Technology Services Department Representative prior to implementation.
- B. Submit Manufacturer's Cut Sheets for the following (Refer to Section 27 00 00 – Communications Submittal):
 - 1. Major items not included in the Product Section.
 - 2. Submit for approval in accordance with specified submittal procedures:
 - a) Racks
 - b) Enclosures
 - c) Patch panels
 - d) Cable Management
 - e) Ladder Racks
 - f) Vertical Cable Managers
 - g) Horizontal Cable Managers
 - h) HVAC system for CD (MDF) / FD (IDF) locations

1.6 QUALITY ASSURANCE:

- A. Manufacturers:
 - 1. Firms regularly engaged in manufacture of the materials, called out for in this section, whose products have been in satisfactory use in similar service for not less than 3 years.
- B. The Contractor will install work in accordance with the latest School District of Osceola County Requirements, the latest BICSI Information Technology Systems Installation Methods Manual, Telecommunications Distribution Methods Manual, TIA/EIA Standard Commercial Building Telecommunications Cabling Standard, systems planning and design manual.
- C. The Contractor installing the Premise cabling system, hardware, components, and devices will be trained by the referenced manufacturer(s) in the proper installation practices. The Contractor will have the proper tools and test equipment to insure a good and proper installation.
- D. Installed UTP and fiber optic cabling systems, pathways, and distribution facilities will adhere to manufacturer's instructions, contract drawings, specifications, applicable codes, standards, and regulations.
- E. Installed UTP cabling systems and field test results will strictly adhere to requirements of ANSI/TIA-568-0.D, ANSI/TIA-568-1.D and ANSI/TIA/EIA-568-2.D.
- F. Installed optical fiber cabling systems and field test results will strictly adhere to requirements of ANSI/TIA-568-0.D and ANSI/TIA/EIA-568-3.D.
- G. Where applicable, all equipment, components, accessories, and hardware will be UL listed for the intended purpose of the installation.
- H. All critical internal manufacturing operations for installed products will have documented in-process inspection and testing according to ISO9001.
- I. Installed products will be manufactured by an ISO 9001 certified facility.
- J. Installed products will be free from defects in material or workmanship from the manufacturer and will be of the quality indicated.

- K. All methods of construction that are not specified in the contract documents will be subject to control and approval by the Project Technology Designer (RCDD) and SDOC Technology Services Department Representative.
- L. Installed products will be lot-traceable by date code.

1.7 DEFINITION:

A. Campus Distributor Room – CD (MDF):

1. The School District of Osceola County (SDOC) established standard for all newly constructed, retrofitted, and renovated CD (MDF) locations will be a minimum of twenty (20) linear feet long by ten (10) linear feet wide (rectangular shape **ONLY**), free of any liquid, HVAC, and electrical conveyance (excluding fire protection and space requirements). CD (MDF) locations shall not support more than 10k square feet of space. No drop ceiling shall be installed in any CD (MDF) location and all flooring shall be "Luxury Vinyl Flooring (LVT)" covering "ONLY" (no other finish shall be installed). Floor covering shall be installed prior to rack placement. "No Storage Allowed" placard shall be displayed at entrance of space. Roof access is not permitted in any CD (MDF) location – **NO EXCEPTIONS**.
2. All CD (MDF) free-standing rack locations shall have a minimum clearance from the rear pad of the free-standing rack to the backboard of forty-eight inches. Installation of these free-standing racks shall be coordinated with and approved by Project Technology Designer (RCDD) and SDOC Technology Services Representative to ensure proper placement prior to anchoring.
3. All CD (MDF) entrance locations are located within the main building enclosure, primary access (no secondary room access) swing open into an open corridor rather than into the telecom space (no exterior access), consisting of a forty-eight (48) inch door configuration (two (2) thirty-six inch double door configuration is acceptable), and keyed appropriately for access by SDOC Technology Services Department authorized Representatives and designates (badged access controlled environment is preferred).
4. All backboards (white in color) are provided and installed by the selected Electrical Contractor, are mounted on all walls as indicated by SDOC predesignated locations and identified as indicated by SDOC approved details and drawings.
5. A minimum of three (3) 4-inch conduits shall feed each FD (IDF) location served from the CD (MDF) location. One (1) conduit shall be designated for copper backbone cabling, One (1) conduit shall be designated for fiber optic backbone cabling, and One (1) shall be designated as "spare". All backbone cabling conduits shall be homerun.
6. One (1) NEMA 5-20R quad power receptacle shall be provided and installed BEHIND equipment rack #1 and #5 at eighty (80) inches above finished floor (A.F.F.), unless otherwise noted (U.O.N.) at SDOC predesignated locations. All technology work areas shall have dedicated load centers (breaker panels). Surface mounted application is not an acceptable solution for new construction.
7. A minimum of two (2) 208 VAC NEMA L6-30R power receptacles for every three (3) free standing system equipment racks shall be installed at SDOC predesignated locations. The installation one (1) additional 208 VAC NEMA L6-30R power receptacle shall be installed at the designated server rack location. Project Technology Designer (RCDD) and SDOC Technology Services Department Representatives reserve the right to increase or decrease quantities (site dependent). All technology work areas shall have dedicated load centers (breaker panels). Surface mounted application is not an acceptable solution for new construction.
8. A minimum of one (1) light fixture in front of and one (1) light fixture to the rear of system rack assemblies providing a minimum of 50 foot candle of lighting at each cable termination location shall be provided and installed. Additional light fixtures shall be installed throughout the CD (MDF) location to provide adequate lighting. All technology work areas shall have dedicated load centers (breaker panels).
9. A minimum of one (1) 120 VAC NEMA 5-20R quad power receptacle on each wall at 18" A.F.F., on the Fire Alarm identified backboard, on the Security identified backboard, and on the DAS identified backboard shall be provided and installed. SDOC Technology Services Department Representative and Project Technology Designer (RCDD) reserve the right to increase or decrease quantities (site dependent). All technology work areas shall have dedicated load centers (breaker panels). Surface mounted application is not an acceptable solution for new construction.
10. An appropriate quantity of STI EZ-Path Series 44 mechanical fire rated raceway on each wall's cable entrance regardless of the fire / smoke rating (or lack thereof) into the CD (MDF) location – EMT sleeving and fire putty is not an acceptable substitution for mechanical fire rated raceway. Value engineered

removal of this requirement shall not be an acceptable option – **NO EXCEPTIONS.**

11. The HVAC Contractor shall provide and install a cooling system capable of maintaining continuous temperatures between 68° and 72° Fahrenheit. Temperature within this location (room) shall not exceed 82° Fahrenheit at any time – **NO EXCEPTIONS.**

B. Floor Distributor Room – FD(IDF):

1. The School District of Osceola County (SDOC) established standard for all newly constructed, retrofitted, and renovated FD (IDF) locations shall be a minimum of ten (10) linear feet long by eight (8) linear feet wide (rectangular shape) free of any liquid, HVAC, and electrical conveyance (excluding fire protection and space requirements). FD (IDF) locations shall not support more than 10k square feet of space. No drop ceiling shall be installed in any FD (IDF) location and all flooring shall be “Luxury Vinyl Flooring (LVT)” covering “ONLY” (no other finish shall be installed). Floor covering shall be installed prior to rack placement. “No Storage Allowed” placard shall be displayed at entrance of space. Roof access is not permitted in any FD (IDF) locations – **NO EXCEPTIONS.**
2. FD (IDF) locations shall be sized based upon the number of free-standing racks employed to service the maximum 10k square feet area:
 - a) Rooms with 2 racks (or less) shall require an area of ten (10) linear feet long by eight (8) linear feet wide creating a rectangular shaped area
 - b) Rooms with 3 racks shall require an area of ten (10) linear feet long by ten (10) linear feet wide, creating a square shaped area
 - c) Rooms with 4 racks shall require an area of ten (10) linear feet long by twelve (12) linear feet wide, creating a rectangular shaped area
 - d) Rooms with 5 racks shall require an area of ten (10) linear feet long by fourteen (14) linear feet wide, creating a rectangular shaped area
 - e) All designs shall incorporate square or rectangular shapes ONLY. No other shapes shall be considered in the creation of Floor Distributor Rooms – FD(IDF)
3. All FD (IDF) free-standing rack locations shall have a minimum clearance from the rear pad of the free-standing rack to the backboard of forty-eight inches. Installation of these free-standing racks shall be coordinated with and approved by Project Technology Designer (RCDD) and SDOC Technology Services Representative to ensure proper placement prior to anchoring.
4. All FD (IDF) entrance locations are located within the building enclosure, primary access (no secondary room access) opening into an open corridor (no exterior access), consisting of a forty-eight (48) inch door configuration, and keyed appropriately for access by SDOC Technology Services Department authorized Representatives and designates (badged access-controlled environment is preferred).
5. All backboards (white in color) are provided and installed by the selected electrical Contractor, are mounted on all walls as indicated by SDOC predesignated locations and identified as indicated by SDOC approved details and drawings.
6. One (1) NEMA 5-20R quad power receptacle shall be provided and installed by the selected Electrical Contractor and shall be mounted BEHIND equipment rack #1 at eighty (80) inches above finished floor (A.F.F.), unless otherwise noted (U.O.N.) at SDOC predesignated locations. Installation of these power receptacles shall be coordinated with and approved by Project Technology Designer (RCDD) and SDOC Technology Services Representative to ensure proper placement prior to installation. All technology work areas shall have dedicated load center (breaker panels). Surface mounted application is not an acceptable solution for new construction.
7. A minimum of two (2) 208 VAC NEMA L6-30R power receptacles for every three (3) free standing systems equipment racks installed at SDOC predesignated locations. Project Technology Designer (RCDD) and SDOC Technology Services Department Representative reserve the right to increase or decrease quantities (site dependent). All technology work areas shall have dedicated load centers (breaker panels). Surface mounted application is not an acceptable solution for new construction.
8. A minimum of one (1) light fixture in front of and one (1) light fixture to the rear of system rack assemblies providing a minimum of 50 foot candle of lighting at each cable termination location. Light fixtures shall be installed throughout the FD (IDF) location to provide adequate lighting in addition to the light fixtures installed in front of and to the rear of the system rack assemblies. All technology work areas shall be dedicated load centers (breaker panels).

9. A minimum of one (1) 120 VAC NEMA 5-20R quad power receptacle on each wall at 18" A.F.F., on the Fire Alarm identified backboard, on the Security identified backboard, on the DAS identified backboard, and installed at SDOC predesignated locations. Project Technology Designer (RCDD) and SDOC Technology Services Department Representative reserve the right to increase or decrease quantities (site dependent). All technology work areas shall have dedicated load centers (breaker panels). Surface mounted application is not an acceptable solution for new construction.
10. An appropriate quantity of STI EZ-Path Series 44 mechanical fire rated raceway on each wall's cable entrance regardless of the fire / smoke rating (or lack thereof) into the FD (IDF) location – EMT sleeving and fire putty is not an acceptable substitution for mechanical fire rated raceway. Value engineered removal of this requirement shall not be an acceptable option – **NO EXCEPTIONS.**
11. The HVAC Contractor shall provide and install a cooling system capable of maintaining continuous temperatures between 68° and 72° Fahrenheit. Temperature within this location (room) shall not exceed 82° Fahrenheit at any time – **NO EXCEPTIONS.**

1.8 WARRANTIES:

- A. Refer to Section 27 00 00 for general details.

1.9 MATERIALS:

- A. All materials shall be UL or ETL listed and verified and shall be marked as such.
- B. Products shall be regularly catalogued items of the manufacturer and shall be supplied as a complete unit in accordance with the manufacturer's standard specifications with any optional items required for proper installation unless otherwise noted.
 1. All materials used on this project shall be new. Used and refurbished equipment are not permitted. Provided equipment on site in original packaging whenever practical.

1.10 DELIVERY, STORAGE AND HANDLING LOGISTICS:

- A. Material shall be delivered to the site in the original packing.
- B. Materials delivered to the construction site shall be stored in a dry, secure area, preferably indoors. Storage temperature of materials shall adhere to manufacturer's recommendations. Movement of packaged materials shall be in a manner to avoid damage of contents. On-site storage, either indoors or trailer, shall have permission by School District of Osceola County Staff, and shall not interfere with other construction activity.
- C. Installation of the cable shall be within the recommended temperature range specified by the manufacturer. Cable installation temperature range between 50° f and 80° f is recommended. Cabling should only be installed in facilities that are not exposed to the elements.
- D. The Contractor is responsible for scheduling all deliveries and providing proper receipt, handling, and storage of all materials. Protect all equipment from physical damages (dents, scratches, dust, water, paint, chemicals, and temperature extremes), vandalism, or theft. The Contractor shall replace any damaged or stolen equipment. The Contractor is responsible for all equipment until final project acceptance by the School District of Osceola County.
- E. The Contractor is responsible for cleaning the worksite every business day and removing debris from the facility.

1.11 COORDINATION WITH OTHER TRADES:

- A. Coordinate layout of work with other trades. Make minor adjustments in locations required for coordination. Locations of structural systems, heating work, and plumbing lines shall take preference over locations of conduit lines where conflict occurs. Structural systems, heating work, and plumbing lines shall not interfere with or otherwise impede the routing of communication cabling with cable tray, raceways, or other pathways dedicated to communications. All potential issues shall be brought to the attention of the General Contractor, Construction Manager, Architect, Engineer, Project Technology Designer (RCDD), and SDOC Technology Services Department Representative immediately, before proceeding with installation.
- B. Other than minor issues, adjustments shall be submitted to the General Contractor, Construction Manager, Architect, Engineer, Project Technology Designer (RCDD), and SDOC Technology Services Department Representative for approval before proceeding with the work.
- C. Coordinate location, arrangement, mounting, and support of all communications provisions with Division 26 Representative, Project Technology Designer (RCDD), and SDOC Technology Services Department

Representative that:

1. Allow maximum possible headroom unless specific mounting heights that reduce headroom are indicated.
 2. Provide for ease of disconnecting the equipment with minimum interference to other installations.
 3. Allow right of way for piping and conduit installed at required slope.
 4. Coordinate that connecting raceways, cables, and cable trays will be clear of obstructions, the workings and access space of other equipment.
 5. Coordinate installation of required supporting devices and set sleeves in cast-in-place concrete, masonry walls, and other structural components as they are constructed.
 6. Coordinate sleeve selection specified in Division 07 and Division 26.
 7. Coordinate location of access panels and doors for electrical items that are behind finished surfaces or otherwise concealed.
 8. Coordinate the gauge cables to be used in the telecommunication grounding system.
- D. Low Voltage Contractor shall furnish and install the following:
1. Racks & Accessories
 2. Enclosures & Accessories
 3. Patch Panels & Accessories
 4. Ladder Racks & Accessories
 5. Grounding within telecommunication rooms, spaces, and locations
- E. Electrical Contractor shall furnish and install the following:
1. Backboards, paint, and labeling (borders)
 2. Power circuits to telecommunication rooms, spaces, equipment, devices, and components
 3. Grounding to telecommunication rooms, spaces, and locations
 4. Coordinate location of electrical receptacles to be installed inside walls or cabinets. Surface mounted conduit and boxes are not an acceptable installation for new construction – **NO EXCEPTIONS**
- F. Unless noted otherwise, the following items will be the responsibility of SDOC Technology Service Department Representative and the School District of Osceola County:
1. All electronics and active data networking equipment, etc.
 2. All port assignments for Fire Alarm, Intercom, DAS, Security, and Intercom
 3. All Telephones, etc.
 4. All PC's, printers, video display terminals (desktop), flat panel displays (desktop), etc.
- G. Contractor will coordinate with SDOC Technology Services Department Representative for network and computer equipment specifications and / or installation requirements before starting Work.
- H. Contractor will coordinate with the Project Technology Designer (RCDD), General Contractor, and SDOC Technology Services Department Representative for location and type of blocking to be installed in the walls to support wall mounted equipment.

PART 2 PRODUCTS:

2.1 PATCH PANELS:

- A. UTP Patch Panels, Category 6A:
1. Keystone acceptable 24-port and 48-port
 2. Non-keyed, unshielded, 4-pair
 3. 8-position, 8-wire (RJ-45)

4. Accommodates T568A wiring
 5. Useable bandwidth beyond 500MHz
 6. Nose Contacts:
 - a) Beryllium copper with a minimum of 50-micro inch gold plating over nickel
 7. Insulation displacement terminals
 8. 110 blocks: Polycarbonate
 9. Jack Contacts: Phosphor bronze with 100 micro-inch tin lead 60/40 over nickel under plating
 10. Terminates 22-24 AWG solid conductors
 11. Minimum Contact Force: 100 grams with FCC compliant 8-position plug
 12. Mating Cycles: 2000+ with FCC compliant 8-position plug
 13. Component Performance shall exceed ANSI/TIA-568-2.D Category 6A component requirements
 14. Panel shall be constructed of 14-gauge steel, rolled edge construction with black powder coat finish.
 15. Panel shall be standard 19-inch rack mount.
 16. Includes rear cable management to the panel
- B. UTP Patch Panels, Category 6:
1. Keystone acceptable 24-port and 48-port
 2. Non-keyed, unshielded, 4-pair
 3. 8-position, 8-wire (RJ-45)
 4. Accommodates T568A
 5. Useable bandwidth beyond 250MHz
 6. Nose Contacts:
 - a) Beryllium copper with a minimum of 50-micro inch gold plating over nickel
 7. Insulation displacement terminals
 8. 110 blocks: Polycarbonate
 9. Jack Contacts: Phosphor bronze with 100 micro-inch tin lead 60/40 over nickel under plating
 10. Terminates 22-24 AWG solid conductors
 11. Minimum Contact Force: 100 grams with FCC compliant 8-position plug
 12. Mating Cycles: 2000+ with FCC compliant 8-position plug
 13. Component Performance shall exceed ANSI/TIA-568-2.D Category 6 component requirements,
 14. Panel shall be constructed of 14-gauge steel, rolled edge construction with black powder coat finish.
 15. Panel shall be standard 19-inch rack mount.
 16. Includes rear cable management to the panel

2.2 FLOOR MOUNT RACKS:

- A. Extruded aluminum construction, black powder coated finish
- B. 19 inches mounting width by 84 inches height with 24-inch full width base
- C. 1000lb. static weight capacity
- D. 12/24 tapped holes, EIA/ECA-310-E Universal Mounting Pattern

- E. 45 rack mount units, +1 on rear for Horizontal Busbar
- F. 10-inch-deep mounting rails
- G. Ladder rack mounting plate attached
- H. Furnish and install rack isolation kit
- I. Furnish and install vertical wire management channels on both sides of rack, type as specified.
- J. Furnish and install horizontal wire management units, quantity and type as specified.
- K. Furnish and install ground terminal block/lug for each rack and #6 AWG ground wire to room ground bus bar.

2.3 ENCLOSURES:

- A. Wall Mount Cabinets:
 - 1. Constructed of Cold Rolled Steel
 - 2. 12-gauge vertical rails
 - 3. 14-gauge sides and doors
 - 4. Black Powder Coating
 - 5. Integrated lock on the side panels, front and rear door
 - 6. 2000lb static load capacity
 - 7. EIA-310-D Universal hole pattern
 - 8. Perforated front and rear doors to optimize airflow
 - 9. Have attachment points for mounting power strips or other accessories
 - 10. #12-24 threaded hole configuration
 - 11. 18 Rack Units (RU)
 - 12. 37"H X 37"W X 25"D
 - 13. Seismic units available where required

2.4 SERVER CABINETS:

- A. Constructed of Cold Rolled Steel
- B. 12-gauge vertical rails
- C. 14-gauge sides and doors
- D. Black Powder Coating
- E. Integrated lock on the side panels, front and rear door
- F. 2000lb static load capacity
- G. EIA-310-D Universal hole pattern
- H. Perforated front and rear doors to optimize air flow
- I. Have attachment points for mounting power strips or other accessories
- J. #12-24 threaded hole configuration
- K. Minimum 42 Rack Units (RU)
- L. Minimum 80"H X 24"W X 42"D
- M. Seismic units available where required

2.5 EQUIPMENT RACK & ENCLOSURE ACCESSORIES:

- A. Power Strip:
 - 1. Electrical Specifications: 20A-120V
 - 2. Receptacle Type: NEMA5-20R
 - 3. 12 Receptacles
 - 4. Surge protected
 - 5. ON-OFF switch
- B. Horizontal Cable Management:
 - 1. 2RU front management ONLY
 - 2. 4" front ring depth
 - 3. Metal construction
 - 4. Front cover
 - 5. Pass-thru holes from front to rear

2.6 VERTICAL CABLE MANAGEMENT:

- A. Equipment Racks:
 - 1. 84"H X 6"W X 10"D
 - 2. 14-gauge cold rolled steel
 - 3. Door with dual hinge and positive latch
 - 4. All steel construction – steel rod support members
 - 5. Black powder coat

2.7 19" FILLER PANELS:

- A. 1RU - 1.75" H
- B. 2RU - 3.5" H
- C. 4RU - 7.0" H

2.8 LADDER RACKS:

- A. 16-gauge tubular steel
- B. Black powder coating
- C. Rung Spacing – 9.0"
- D. Size: 18"
- E. Stringer dimensions: 0.375"W X 1.5"H
- F. RoHS Compliant
- G. Accessories:
 - H. Butt Splice
 - I. Cable Radius Drop
 - J. Foot Kit
 - K. J-Bolt Kit
 - L. Protective End Caps
 - M. Swivel Splice Kit

- N. T-Junction Splice Kit
- O. Triangle Wall Supports
- P. Wall Angle Support
- Q. Vertical Wall Bracket
- R. Ground Strap, Splices
- S. TEBC Bracket

2.9 PLYWOOD BACKBOARDS:

- A. An AC grade or better, void-free plywood backboard, 8 ft. high with a minimum thickness of 0.75 in, securely fastened with the grade C surface facing the supporting wall.
- B. Treated with two coats of white, nonconductive, fire-resistant coating.
- C. Mounted 6" off the finished floor
- D. All walls shall be finished with identified backboard.
- E. Backboard installation shall be complete before equipment installation begins.

2.10 BONDING:

- A. Rack & Enclosure:
 - 1. 19" busbar
 - 2. Insulators
 - 3. Mounting hardware
 - 4. # 6 AWG cable with lug attached
 - 5. 4 mm banana plug
 - 6. Antioxidant
- B. Ladder Rack Splice:
 - 1. 9" strap with double hole lugs on each end
 - 2. Stainless steel mounting hardware
 - 3. Tube of antioxidant

PART 3 EXECUTION:

3.1 INSTALLATION:

- A. All termination hardware shall be installed in accordance with manufacturer's recommended installation procedures.
- B. All hardware shall be placed so as to make efficient use of available space in coordination with other uses. All wiring and associated hardware shall be placed to not impair or impede the use or capacity of other building systems, equipment, or hardware placed by others (or existing).
- C. Hardware shall be installed as to avoid interference with any other service, system, operation, or maintenance purposes such as access boxes, equipment, mechanical equipment access doors, covers, switches, electrical panels, and lighting fixtures. Hardware shall be installed to maintain a minimum 48 inch (from edge of pad) working clearance in the front and rear of all racks and cabinets (U.O.N.).
- D. Contractor shall attach all floor mount racks and cabinets to building structure with hardware as required by manufacturer, 3/8-inch hardware minimum. Furnish and install seismic rated hardware where required by local codes. Furnish and install raised floor mounting kits for racks and cabinets installed on raised floors.
- E. Contractor shall attach all wall mount racks and cabinets to building structure with hardware as required by the manufacturer. All wall mount racks and cabinets shall be mounted on plywood backboards. Wall mount racks and cabinets on gypsum wall board walls shall be attached through the plywood and fastened to steel (or

wood) studs or steel (or wood) blocking in the wall (where applicable).

- F. Rack configurations indicated on details and drawings are typical and may not reflect final installation in all telecommunication rooms, locations, and spaces. Contractor shall coordinate final rack layouts with fiber termination enclosures, patch panels, and wire management panels with Project Technology Designer (Project Electrical Engineer and Registered Communication Distribution Designer (RCDD)) and SDOC Technology Services Department Representative prior to securing. Violation of this procedure may result in additional cost, provided by Contractor, to correct any deviations to the satisfaction of Project Technology Designer (RCDD) and SDOC Technology Services Department Representative.
- G. Furnish and install quantity of Velcro wraps as required for proper cable bundling, organization, and support. Plastic or nylon cable ties and tape are not acceptable for use on any category rated cable.
- H. Contractor shall coordinate with Project Technology Designer (RCDD) and SDOC Technology Services Department Representative for placement of blocking in walls where wall mount cabinets are to be installed.
- I. Furnish and install 3/4-inch-wide hook and loop fasteners to bundle all cables in telecommunications rooms, spaces, locations, and other areas of telecommunication cable terminations, minimum 8 inches in length.

3.2 PLYWOOD BACKBOARDS:

- A. Plywood backboards shall be installed on all walls of telecommunication rooms.
- B. Plywood backboards in larger spaces shall be installed as indicated on details and drawings.
- C. Plywood backboards shall be installed from corner to corner with no gaps between boards.
- D. Plywood backboards shall be attached across a minimum of three wall studs. Install plywood backboards in a horizontal orientation where possible to span more than three wall studs.
- E. Install plywood backboards in telecommunication rooms at 6 inches A.F.F. to the bottom edge of the backboard and 102 inches to the top edge of the backboard.
- F. Plywood backboards in telecommunications spaces shall be painted front and back and all edges (including cut-outs) with two coats of white fire-retardant paint.
- G. Plywood backboards in areas other than telecommunication rooms shall be painted front, back and all edges with two coats of white colored fire-retardant paint. Coordinate paint color with Architect, Project Technology Designer (Project Electrical Engineer and Registered Communication Distribution Designer (RCDD)) and SDOC Technology Services Department Representative.

END OF SECTION 27 11 10

[REMAINDER OF PAGE INTENTIONALLY LEFT BLANK]

SECTION 27 13 13

COMMUNICATIONS COPPER BACKBONE CABLING

PART 1 GENERAL:

1.1 INTRODUCTION:

A Copper Backbone Cabling:

1. The work covered by this section of the Specifications includes all labor necessary to perform and complete such construction, all materials and equipment incorporated or to be incorporated in such construction and all services, facilities, tools and equipment necessary or used to perform and complete such construction. The work of this section shall include, but is not limited to, the following:
 - a) Voice copper backbone cabling and accessories in accordance with the strictest manufacturer written recommendation per code or the best industry practice. These following communication Specifications are requirements for all School District of Osceola County (SDOC) projects. Request for deviations from these guides and requirements must be made in writing to the School Board of Osceola County.

1.2 RELATED DOCUMENTS:

A Division 27 Sections that apply to this Section are:

1. Section 27 00 00 Communications
2. Section 27 05 26 Grounding & Bonding for Communications Systems
3. Section 27 05 28 Pathways for Communications Systems
4. Section 27 05 36 Cable Trays for Communications Systems
5. Section 27 11 10 Telecommunications Spaces, Equipment and Fittings
6. Section 27 13 23 Communications Optical Fiber Backbone Cabling
7. Section 27 15 13 Communications Copper Horizontal Cabling
8. Section 27 15 43 Communications Faceplates and Modules
9. Section 27 16 19 Communications Patch Cords and Station Cords
10. Section 27 21 33 Wireless Access Points System
11. Section 27 41 16 Classroom Amplification System
12. Section 27 51 23 Educational Intercom and Program Clock System
13. Section 27 53 21 Distributed Antenna System – Public Safety

1.3 STANDARDS AND CODES:

- A Refer to other sections in Division 27 00 00 – Communications
- B Refer to Division 01 – Reference Standards and General Conditions of the Contract.
- C Complies with both ANSI/TIA-607-C and NEC Article 250. The most stringent rules apply.

1.4 APPROVED PRODUCT MANUFACTURERS:

- A The manufacturers of the copper cabling, that School District of Osceola County is using as basis of design in this document, as required for construction of the cabling infrastructure per contract documents shall be:
 - B Hubbell Premise Wiring
 - C Product substitutions from other manufacturers shall require the approval of the Project Technology Designer (Project Electrical Engineer and Registered Communication Distribution Designer (RCDD)) and SDOC Technology Services Department Representative 10 business days prior to bid opening.

1.5 SUBMITTALS:

- A Shop Drawings:
 - 1. Shop drawing will indicate the location of cable routes, bundle sizes, and penetrations (including cable trays, mechanical firestops, and interior / exterior sleeving), and will require the approval of the Project Technology Designer (Project Electrical Engineer and Registered Communication Distribution Designer (RCDD)) and SDOC Technology Services Department Representative prior to implementation.
- B. Submit Manufacturer's Cut Sheets for the following (Refer to Section 27 00 00 – Communications Submittal):
 - 1. Major items not included in the Product section.
 - 2. Submit for approval in accordance with specified submittal procedures:
 - a) Cable
 - b) Connections
 - c) Enclosures
 - d) Inner Duct
 - e) Vaults

1.6 QUALITY ASSURANCE:

- A Manufacturers:
 - 1. Firms regularly engaged in manufacture of the materials, called out for in this section, whose products have been in satisfactory use in similar service for not less than 3 years.
- B. The Contractor will install work in accordance with the latest School District of Osceola County Requirements, the latest BICSI Information Technology Systems Installation Methods Manual, Telecommunications Distribution Methods Manual, TIA/EIA Standard Commercial Building Telecommunications Cabling Standard, systems planning and design manual.
- C. The Contractor who is installing the materials and installing the system will be trained by the referenced manufacturer in the proper installation practices. The Contractor will have the proper tools and test equipment to insure a good and proper installation.
- D. Installed UTP cabling systems, pathways and distribution facilities will adhere to manufacturer's instructions, contract drawings and specifications, and applicable codes, standards, and regulations.
- E. Installed UTP cabling systems and field test results will strictly adhere to requirements of ANSI/TIA-568-0.D, ANSI/TIA-568-1.D and ANSI/TIA/EIA-568-2.D.
- F. Where applicable, all equipment, components, accessories, and hardware will be UL listed for the intended purpose of the installation.
- G. All critical internal manufacturing operations for installed products will have documented in-process inspection and testing according to ISO9001.
- H. Installed products will be manufactured by an ISO9001 certified facility.
- I. Installed products will be free from defects in material or workmanship from the manufacturer and will be of the quality indicated.
- J. All methods of construction that are not specified in the contract documents will be subject to control and approval by the Project Technology Designer (RCDD) and SDOC Technology Services Department Representative.
- K. Installed products will be lot-traceable by date code.

1.7 DEFINITION:

- A CMP: Communications Plenum Cable
- B CMR: Communications Riser Cable
- C MPP: Multipurpose Plenum Cable
- D PE: OSP Cable

1.8 WARRANTIES:

- A Refer to Section 27 00 00 for general details.

1.9 MATERIALS:

- A All materials shall be UL or ETL listed and verified and shall be marked as such.
- B Products shall be regularly catalogued items of the manufacturer and shall be supplied as a complete unit in accordance with the manufacturer's standard specifications with any optional items required for proper installation unless otherwise noted.
 - 1. All materials used on this project shall be new. Used and refurbished equipment are not permitted. Provided equipment on site in original packaging whenever practical.

1.10 DELIVERY, STORAGE AND HANDLING LOGISTICS:

- A Material shall be delivered to the site in the original packing.
- B Materials delivered to the construction site shall be stored in a dry, secure area, preferably indoors. Storage temperature of materials shall adhere to manufacturer's recommendations. Movement of packaged materials shall be in a manner to avoid damage of contents. On-site storage, either indoors or trailer, shall have permission by the School District of Osceola County Staff, and shall not interfere with other construction activity.
- C Installation of the cable shall be within the recommended temperature range specified by the manufacturer. Cable installation temperature range between 50°F and 80°F is recommended. Cabling should only be installed in facilities that are not exposed to the elements.
- D The Contractor is responsible for scheduling all deliveries and providing proper receipt, handling, and storage of all materials. Protect all equipment from physical damages (dents, scratches, dust, water, paint, chemicals, and temperature extremes) and vandalism, or theft. The Contractor shall replace any damaged or stolen equipment. The Contractor is responsible for all equipment until final project acceptance by the School District of Osceola County.
- E The Contractor is responsible for cleaning the worksite every business day and removing debris from the facility.

1.11 COORDINATION WITH OTHER TRADES:

- A Coordinate layout of work with other trades. Make minor adjustments in locations required for coordination. Locations of structural systems, heating work and plumbing lines shall take preference over locations of conduit lines where conflict occurs. Structural systems, heating work, and plumbing lines shall not interfere with or otherwise impede the routing of communication cabling with cable tray, raceways, or other pathways dedicated to communications. All potential issues shall be brought to the attention of the General Contractor, Construction Manager, Architect, Engineer, Project Technology Designer (RCDD), and SDOC Technology Services Department Representative immediately, before proceeding with installation.
- B Other than minor issues, adjustments shall be submitted to the General Contractor, Construction Manager, Architect, Engineer, Project Technology Designer (RCDD), and SDOC Technology Services Department Representative for approval before proceeding with the work.
- C Coordinate location, arrangement, mounting, and support of all communications provisions with Division 26 Representative, Project Technology Designer (RCDD), and SDOC Technology Services Department Representative that:
 - 1. Allow maximum possible headroom unless specific mounting heights that reduce headroom are indicated.
 - 2. Provide for ease of disconnecting the equipment with minimum interference to other installations.
 - 3. Allow right of way for piping and conduit installed at required slope.
 - 4. Coordinate that connecting raceways, cables, and cable trays will be clear of obstructions and of the working and access space of other equipment.
 - 5. Coordinate installation of required supporting devices and set sleeves in cast-in-place concrete, masonry walls, and other structural components as they are constructed.
 - 6. Coordinate sleeve selection specified in Division 07 and Division 26.

7. Coordinate location of access panels and doors for electrical items that are behind finished surfaces or otherwise concealed.
8. Coordinate the gauge cables to be used in the telecommunications grounding system.

PART 2 PRODUCTS:

2.1 CABLES:

- A. PE – Polyethylene insulated cabling:
 1. Outside Plant Telephone cable
 2. Solid copper conductors
 3. External layer of solid, high-density polyethylene insulation with distinctive color code conforming to telephone industry standards. Conductors are twisted pairs then bundled together
 4. Internal core filled with ETPR compound
 5. Black polyethylene inner jacket
 6. Corrugated aluminum tape shield over inner jacket
 7. Meets ANSI/ICEA S-84-608

PART 3 EXECUTION:

3.1 GENERAL:

- A. Backbone Copper cables are for use between telecommunications facilities within the same building.
- B. Backbone copper cables are used between buildings within the same campus inside conduit and edge detectable three (3) cell fabric inner duct. Distance from CD (MDF) / FD (IDF) location and between communication vaults shall not exceed 500 feet.
- C. Location, pair count, and placement detail for all copper cables shall be as shown on the conformed drawings.
- D. Provide 10' slack loops at the CD (MDF) and at each FD (IDF) location's end of all backbone copper cables.
- E. EMT Conduits of the proper rating shall run between each telecommunication location w/ two (2) three (3) cell fabric innerducts in each conduit.
- F. Label each end of each cable as to source and destination. Terminate pairs in consistent, consecutive manner at each end. Place all material in inner duct. Label copper raceway cable with yellow "caution - copper cable" tags every 10 feet. Leave 10 feet of slack at each copper termination point.
- G. Copper backbone cable terminations shall utilize enclosures and components in quantities consistent with the required pair counts at each end of each segment.
- H. All copper backbone cabling shall have proper primary and secondary lightning protection installed.
- I. Using approved methods, pull cable into conduit, or place into raceway or cable tray as specified. A pull cord (nylon; 1/8" minimum) shall be co-installed with all cable installed in any conduit. Verify pull cord is free of entanglement and is not wrapped around installed cable.
- J. Each copper riser cable shall be placed within one cell of innerduct.
- K. Fiber optic cables and copper cables shall not share conduit or innerduct.
- L. Do not install patch cables until after the copper test reports have been accepted by Project Technology Designer (Project Electrical Engineer and Registered Communication Distribution Designer (RCDD)) and SDOC Technology Services Department Representative.

3.2 QUANTITIES:

- A. Quantities of system elements shown on the drawings are illustrative only and are meant to indicate the general configuration of the work. The Contractor is responsible for providing the correct quantities of materials to construct a system that meets the intent of these Specifications and the relevant codes.
- B. Typical quantities of cabling are as follows:
 1. Twelve pair of appropriate type (CMP, CMR, PE) copper homerun cabling shall be installed between CD (MDF) and each FD (IDF) location.

3.3 INSTALLATION:

A. Copper Backbone Cables:

1. All copper installations shall be installed using open cabling methods. Limit cable-bending radius to 10 times the cable diameter during installation, and 10 times the diameter after installation. Provide all required tools, materials, consumables, and equipment necessary for field mounting of connectors.
2. Provide support for vertical runs of copper riser cables.
3. Route copper cables together as a single bundle, not to be combined with fiber optic or coax cabling.
4. Do not exceed the maximum pull tension specified by the cable manufacturer. Use appropriate lubricants as required to reduce pulling friction. Avoid kinking and twisting of cables during installation.
5. During installation of copper cabling, do not allow pulling tension to exceed cable manufacturer's specification for the cable being installed. Only the strength member of the cable shall be subjected to the pulling tension.
6. Follow all manufacturers' specifications for installation.

3.4 IDENTIFICATION:

- A. All copper backbone and riser cables must be labeled with a self-laminating label within 12 inches of the termination.
- B. All cable tags shall be easily accessible, both physically and visually, upon completion of the job.

3.5 GROUNDING & BONDING:

- A. Any use of armored cable shall require the bonding of that shield to the PBB/SBB with a #6 AWG copper bonding conductor.
- B. Refer to Section 27 05 26 for additional details.

3.6 TESTING:

A. GENERAL:

1. The Contractor shall test, as described below, all copper cables installed under these Specifications.
2. Visually inspect all cables, cable reels, and shipping cartons to detect cable damage incurred during shipping and transport. Return visibly damaged items to the manufacturer.
3. Testing shall not be performed until after all hardware is installed and attached, and all labeling and identification has been completed.
4. Any cable that does not pass all required testing shall be removed, replaced, and retested.
5. Remove and replace any defective cables from pathways system. Do not abandon cables in place.
6. Project Technology Designer (Project Electrical Engineer and Registered Communication Distribution Designer (RCDD)) and SDOC Technology Services Department Representative reserve the right to observe all portions of the testing process.
7. Project Technology Designer (Project Electrical Engineer and Registered Communication Distribution Designer (RCDD)) and SDOC Technology Services Department Representative further reserve the right to conduct "Proof of performance testing", using Contractor equipment and labor, a random re-test of at least ten percent (10%) of the plant cable to confirm documented test results.
8. Perform all tests as required by the manufacturer in support of the structured cabling system warranty.

3.7 ACCEPTANCE:

- A. All test results and corrective procedures are to be documented and submitted in Microsoft Excel or CSV format to the Project Technology Designer (Project Electrical Engineer and Registered Communication Distribution Designer (RCDD)) and SDOC Technology Services Department Representative within five (5) working days of test completion.
 1. Each test report shall contain the following general information:
 2. Date of Preparation
 3. Date of Test

4. Project Name
 5. Contractor's Name
 6. Media Type
 7. Make, Model and Serial Number of test equipment used
 8. Date of Last Calibration
 9. Names of Test Crew
 10. Submit the following information regarding the copper cable testing:
 11. Cable Number
 12. Pair Count
 13. Connector Types
 14. Number of Connectors / Patches
 15. Length of Run
 - B. Test result shall be recorded per cable and identical copies placed on three removable media devices (USB Flash Drive) for delivery to the Project Technology Designer (Project Electrical Engineer and Registered Communication Distribution Designer (RCDD)) and SDOC Technology Services Department Representative.
 - C. Once the testing has been completed and the Project Technology Designer (Project Electrical Engineer and Registered Communication Distribution Designer (RCDD)) and SDOC Technology Services Department Representative are satisfied that all work is in accordance with the Contract Documents, the Representative will notify the Contractor and / or project manager in writing or via email.
- 3.8 RECORD (AS BUILT) DRAWINGS:
- A. The Project Record Drawings shall show the types and locations of all copper cabling and copper termination points. Drawings should include identifying information from the cable identification tags.

END OF SECTION 27 13 13

[REMAINDER OF PAGE INTENTIONALLY LEFT BLANK]

SECTION 27 13 23

COMMUNICATIONS FIBER OPTIC BACKBONE CABLING

PART 1 GENERAL:

1.1 INTRODUCTION:

A. Fiber Optic Backbone Cabling:

1. The work covered by this section of the Specifications includes all labor necessary to perform and complete such construction, all materials and equipment incorporated or to be incorporated in such construction and all services, facilities, tools and equipment necessary or used to perform and complete such construction. The work of this section shall include, but is not limited to, the following:
 - a) Technology Fiber Optic cabling and accessories in accordance with the strictest manufacturer written recommendation per code or the best industry practice. These communication specifications are requirements for all School District of Osceola County (SDOC) projects. Request for deviations from these guides and requirements must be made in writing to the School Board of Osceola County.

1.2 RELATED DOCUMENTS:

A. Division 27 Sections that apply to this Section are:

1. Section 27 00 00 Communications
2. Section 27 05 26 Grounding & Bonding for Communications Systems
3. Section 27 05 28 Pathways for Communications Systems
4. Section 27 05 36 Cable Trays for Communications Systems
5. Section 27 11 10 Telecommunications Spaces, Equipment and Fittings
6. Section 27 13 13 Communications Copper Backbone Cabling
7. Section 27 15 13 Communications Copper Horizontal Cabling
8. Section 27 15 43 Communications Faceplates and Modules
9. Section 27 16 19 Communications Patch Cords and Station Cords
10. Section 27 21 33 Wireless Access Point System

1.3 STANDARDS AND CODES:

- A. Refer to other sections in Division 27 00 00 – Communications
- B. Refer to Division 01 – Reference Standards and General Conditions of the Contract
- C. Complies with both ANSI/TIA-607-C and NEC Article 250. The most stringent rules apply.

1.4 APPROVED PRODUCT MANUFACTURERS:

- A. The manufacturers of the fiber optic cabling, that School District of Osceola County is using as basis of design in this document, as required for construction of the cabling infrastructure per contract documents shall be:
 1. Corning Optical Communications
 2. Hubbell Premise Wiring
- B. Product substitutions from other manufacturers shall require the approval of the Project Technology Designer (Project Electrical Engineer and Registered Communication Distribution Designer (RCDD)) and SDOC Technology Services Department Representative 10 business days prior to bid opening.

1.5 SUBMITTALS:

A. Shop Drawings:

1. Shop drawing will indicate the location of cable routes, bundle sizes, and penetrations (including cable trays, mechanical firestops, and interior / exterior sleeving), and will require the approval of the Project Technology Designer (Project Electrical Engineer and Registered Communication Distribution Designer (RCDD)) and SDOC Technology Services Department Representative prior to implementation.

- B. Submit Manufacturer's Cut Sheets for the following (Refer to Section 27 00 00 – Communications Submittal):

1. Major items not included in the Product Section
2. Submit for approval in accordance with specified submittal procedures:
 - a) Cable
 - b) Connections
 - c) Enclosures
 - d) Adapter Panels
 - e) Inner Duct
 - f) Vaults

1.6 QUALITY ASSURANCE:

- A. Manufacturers:
 1. Firms regularly engaged in manufacture of the materials, called out for in this section, whose products have been in satisfactory use in similar service for not less than 3 years.
- B. The Contractor will install work in accordance with the latest School District of Osceola County Requirements, the latest BICSI Information Technology Systems Installation Methods Manual, Telecommunications Distribution Methods Manual, TIA/EIA Standard Commercial Building Telecommunications Cabling Standard, systems planning and design manual.
- C. The Contractor who is installing the materials and systems will be trained by the referenced manufacturer in the proper installation practices. The Contractor will have the proper tools and test equipment to ensure a good and proper installation.
- D. Installed fiber optic cabling systems, pathways and distribution facilities will adhere to manufacturer's instructions, contract drawings and specifications, and applicable codes, standards, and regulations.
- E. Installed optical fiber cabling systems and field test results will strictly adhere to requirements of ANSI/TIA-568-0.D AND ANSI/TIA/EIA-568-3.D.
- F. Where applicable, all equipment, components, accessories, and hardware will be UL listed for the intended purpose of the installation.
- G. All critical internal manufacturing operations for installed products will have documented in-process inspection and testing according to ISO9001.
- H. Installed products will be manufactured by an ISO9001 certified facility.
- I. Installed products will be free from defects in material or workmanship from the manufacturer and will be of the quality indicated.
- J. All methods of construction that are not specified in the contract documents will be subject to control and approval by the Project Technology Designer (RCDD) and SDOC Technology Services Department Representative.
- K. Installed products will be lot-traceable by date code.

1.7 DEFINITION:

- A. CMP: Communications Plenum Cable
- B. CMR: Communications Riser Cable
- C. MPP: Multipurpose Plenum Cable
- D. OFNP: Optical Fiber Nonconductive Plenum Cable
- E. OFCP: Optical Fiber Conductive Plenum Cable
- F. LSZR: Low Smoke Zero Halogen Rated Cable
- G. OM1: Defined by ISO 11801 & TIA-492-AAAA, 62.5/125µm multimode fiber.
- H. OM2: Defined by ISO 11801 & TIA-492-AAAB, 50/125µm multi-mode fiber.
- I. OM3: Defined by ISO 11801 & TIA-492-AAAC, laser-optimized 50/125µm multi-mode fiber
- J. OM4: Defined by TIA-492-AAAD, laser-optimized 50/125µm multi-mode fiber
- K. OS1: Defined by TIA-492CAAA / OS1, 9/125µm single mode fiber

L. OS2: Defined by TIA-492CAAB / OS2, 9/125µm single mode fiber

1.8 WARRANTIES:

A. Refer to Section 27 00 00 for general details.

1.9 MATERIALS:

A. All materials shall be UL or ETL listed and verified and shall be marked as such.

B. Products shall be regularly catalogued items of the manufacturer and shall be supplied as a complete unit in accordance with the manufacturer's standard specifications with any optional items required for proper installation unless otherwise noted.

1. All materials used on this project shall be new. Used and refurbished equipment are not permitted. Provided equipment on site in original packaging whenever practical.

1.10 DELIVERY, STORAGE AND HANDLING LOGISTICS:

A. Material shall be delivered to the site in the original packing.

B. Materials delivered to the construction site shall be stored in a dry, secure area, preferably indoors. Storage temperature of materials shall adhere to manufacturer's recommendations. Movement of packaged materials shall be in a manner to avoid damage of contents. On-site storage, either indoors or trailer, shall have permission by the School District of Osceola County Staff, and shall not interfere with other construction activity.

C. Installation of the cable shall be within the recommended temperature range specified by the manufacturer. Cable installation temperature range between 50^of and 80^of is recommended. Cabling should only be installed in facilities that are not exposed to the elements.

D. The Contractor is responsible for scheduling all deliveries and providing proper receipt, handling, and storage of all materials. Protect all equipment from physical damages (dents, scratches, dust, water, paint, chemicals, and temperature extremes) and vandalism, or theft. The Contractor shall replace any damaged or stolen equipment. The Contractor is responsible for all equipment until final project acceptance by the School District of Osceola County.

E. The Contractor is responsible for cleaning the worksite every business day and removing debris from the facility.

1.11 COORDINATION WITH OTHER TRADES:

A. Coordinate layout of work with other trades. Make minor adjustments in locations required for coordination. Locations of structural systems, heating work and plumbing lines shall take preference over locations of conduit lines where conflict occurs. Structural systems, heating work, and plumbing lines shall not interfere with or otherwise impede the routing of communication cabling with cable tray, raceways, or other pathways dedicated to communications. All potential issues shall be brought to the attention of the General Contractor, Construction Manager, Architect, Engineer, Project Technology Designer (RCDD), and SDOC Technology Services Department Representative immediately, before proceeding with installation.

B. Other than minor issues, adjustments shall be submitted to the General Contractor, Construction Manager, Architect, Engineer, Project Technology Designer (RCDD), and SDOC Technology Services Department Representative for approval before proceeding with the work.

C. Coordinate locations, arrangement, mounting, and support of all communications provisions with Division 26 Representative, Project Technology Designer (RCDD), and SDOC Technology Services Department Representative that:

1. Allow maximum possible headroom unless specific mounting heights that reduce headroom are indicated.
2. Provide for ease of disconnecting the equipment with minimum interference to other installations.
3. Allow right of way for piping and conduit installed at required slope.
4. Coordinate that connecting raceways, cables, and cable trays will be clear of obstructions and of the working and access space of other equipment.
5. Coordinate installation of required supporting devices and set sleeves in cast-in-place concrete, masonry walls, and other structural components as they are constructed.
6. Coordinate sleeve selection specified in Division 07 and Division 26
7. Coordinate location of access panels and doors for electrical items that are behind finished surfaces or otherwise concealed.

8. Coordinate the gauge cables to be used in the telecommunications grounding system.

PART 2 PRODUCTS:

2.1 CABLES:

A. Fiber Optic Cables – General:

1. Cable jacket marking must be legible and shall contain the following information:
 - a) Manufacturer's name and trademark
 - b) Strand count
 - c) Cable Type
 - d) Pair Count
 - e) UL listing
 - f) Sequential distance markings, in one-foot (or meter) increments

B. Fiber Optic Cable – Riser:

1. Single mode cable consisting of a minimum of 24 fibers in one jacket (unless otherwise noted).
2. Multimode cable consisting of a minimum of 6 fibers in one jacket (unless otherwise noted).
3. All single mode shall be OS2, 9µm loose tube single mode fiber.
 - a) Standard wavelengths – 1310 nm and 1550 nm.
4. All multimode shall be OM3 or OM4, 50µm loose tube fiber.
 - a) Standard wavelengths – 850 nm and 1300 nm.
5. Non-Armored, Riser rated, OM3 or OM4 Distribution Cable
6. Jacket color shall be aqua (OM3 or OM4).
7. Manufacturer/Product:
 - a) Corning Optical Communications
 - b) Hubbell Premise Wiring

C. OSP Armored Fiber Optic Cable:

1. Outdoor Armored Loose Tube
 - a) Jacket color shall be black.
2. Single mode cable consisting of a minimum of 24 fibers in one jacket (unless otherwise noted).
3. Multimode cable consisting of a minimum of 6 fibers in one jacket (unless otherwise noted).
4. All single mode shall be OS2, 9µm loose tube single mode fiber.
 - a) Standard wavelengths – 1310 nm and 1550 nm.
5. All multimode shall be OM3 or OM4, 50µm loose tube fiber.
 - a) Standard wavelengths – 850 nm and 1300 nm.
6. Non-Armored, Riser rated, OM3 or OM4 Distribution Cable
 - a) Jacket color shall be aqua (OM3 or OM4).
7. Manufacturer/Product:
 - a) Corning Optical Communications
 - b) Hubbell Premise Wiring

2.2 CONNECTORS, FIBER OPTIC:

A. LC - Pre-polished

1. Aqua Housing
2. Precision low-loss, factory polished connector with integral splice and fiber clamp

3. Simple and fast connector termination, with no adhesives or field polishing required
4. Provisions for visual light source verification to achieve optimal splice transmission
5. Wide operating temperature range for thermally stable optical performance
6. Insertion loss: 0.5dB
7. Multimode return loss: 35dB Typical, 22dBmin
8. Operating temperature range: -40°C to +75°C
9. Mating durability: 500 cycles <0.1 dB change
10. Zirconia ferrule: UPC polish

2.3 FIBER OPTIC ENCLOSURE:

- A. 1U Rack Mount Enclosure
- B. Full 17" Depth, with Slide-Out Inner Drawer
- C. One-Piece Removable Cover and Latching Door
- D. Accepts all Standard FSP-Series Panels
- E. Accepts all plug and play cassettes
- F. Material: 16-gauge cold rolled steel
- G. Finish: Black powder coated
- H. FSP Panel Capacity 3
- I. Splice Tray Capacity 2
- J. Max LC Port Capacity 72
- K. Dimensions: 1.75 (44) x 17 (432) x 17 (432)

PART 3 EXECUTION:

3.1 GENERAL:

- A. Backbone fiber optic cables are for use between telecommunications facilities within the same building.
- B. Backbone fiber optic cables are used between buildings within the same campus inside conduit and edge detectable three (3) cell fiber innerduct. Distance from CD (MDF) / FD (IDF) location and between communication vaults shall not exceed 500 feet.
- C. Location, fiber count and placement detail for all fiber optic cables shall be as shown on the conformed drawings.
- D. Provide 10' slack loops at the CD (MDF) and at each FD (IDF) location's end of all backbone fiber optic cables.
- E. Provide 36" of stripped strands fiber wrapped neatly at each fiber cabinet.
- F. All strain relief shall be **braided** and secure properly to LIU in accordance with manufacturers' provided strain relief bracket.
- G. Ensure no fiber optic cables installed are subject to strain, and that correct bend radiuses are maintained at all times.
- H. EMT Conduits (4) of the proper rating shall run between each telecommunication location w/ two (2) three (3) cell fabric innerducts in each conduit.
- I. Label each end of each cable as to source and destination. Terminate optical fibers in consistent, consecutive manner at each end utilizing factory polished connectors (fusion splice). Place all material in inner duct. Label fiber optical raceway cable with yellow "caution - fiber optical cable" tags every 10 feet. Leave 10 feet of slack at each fiber termination point. Neatly coil slack fiber optic cable on top of rack above fiber optic patch panel enclosure at each rack location.
- J. Fiber Optic cable terminations shall utilize enclosures and components in quantities consistent with the required fiber counts at each end of each segment.
- K. Clean all fiber optic connector tips prior to inserting them into mating receptacles or bulkheads. Install all dust covers.

- L. Using approved methods, pull cable into conduit, or place into raceway or cable tray as specified. A pull cord (nylon; 1/8" minimum) shall be co-installed with all cable installed in any conduit. Verify pull cord is free of entanglement and is not wrapped around installed cable.
- M. Do not combine terminations of fiber optic cables leading to different endpoints into a single cabinet unless otherwise noted (U.O.N.). Each distribution, riser, OSP or Fire Alarm serving cable shall require their own, dedicated fiber termination cabinet (LIU) (unless otherwise specified by Project Technology Designer (RCDD)).
- N. Each fiber optic riser cable shall be placed within one cell of fiber innerduct.
- O. Fiber optic cables and copper cables shall not share conduit or fiber innerduct.
- P. Do not install patch cables until after the fiber optic test reports have been accepted by Project Technology Designer (Project Electrical Engineer and Registered Communication Distribution Designer (RCDD)) and SDOC Technology Services Department Representative.

3.2 QUANTITIES:

- A. Quantities of system elements shown on the drawings are illustrative only and are meant to indicate the general configuration of the work. The Contractor is responsible for providing the correct quantities of materials to construct a system that meets the intent of these Specifications and the relevant codes.
- B. Typical quantities of cabling are as follows:
 1. Twenty-four strand single mode (OS2) loose tube fiber optic homerun cabling shall be installed between CD (MDF) and each FD (IDF) location.
 2. Six (6) strand multi-mode (OM3) loose tube fiber optic homerun cabling shall be installed between CD (MDF) and each FD (IDF) location.

3.3 INSTALLATION:

- A. Fiber Optic Backbone Cables:
 1. All fiber optic cable installations shall be installed via conduit and fiber innerduct. Limit cable-bending radius to 20 times the cable diameter during installation, and 10 times the diameter after installation. Provide all required tools, materials, consumables, and equipment necessary for field mounting of connectors.
 2. Provide support for vertical runs of fiber optic riser cables.
 3. Route fiber optic cables together as a single bundle, not to be combined with copper or coax cabling.
 4. Do not exceed the maximum pull tension specified by the cable manufacturer. Use appropriate lubricants as required to reduce pulling friction. Avoid kinking and twisting of cables during installation.
 5. During installation of fiber optic cable, do not allow pulling tension to exceed cable manufacturer's specification for the cable being installed. Only the strength member of the cable shall be subjected to the pulling tension.
 6. Follow all manufacturers' specifications for installation.
- B. Connector Installation:
 1. Do not terminate fiber until after the rack locations and elevations of fiber cabinets (LIUs) have been accepted by Project Technology Designer (Project Electrical Engineer and Registered Communication Distribution Designer (RCDD)) and SDOC Technology Services Department Representative.
 2. Terminate both ends, fibers will be terminated in strict compliance with the manufacturer's printed instructions.
 3. Termination (fusion splice) all Fiber Optic cabling to LC fiber cassette for installation in all LIU applications per manufacturer's specifications.
 4. Breakout kits will be required on all Fiber Optic cables installed per manufacturer's specifications.
 5. All Fiber Optic connectors shall be factory manufactured and fiber spliced per manufacturer's specifications.
 6. Unacceptable flaws in the terminations will include, but not limited to, scratches, full or partial cracks, bubbles, pits, epoxy residual, dirt, dust, oil, moisture, grinding and sanding debris. The acceptable termination will show a connector tip that is free of all imperfections in 100% of the core and 80% of the cladding. All unacceptable connectors shall be inspected after rework.
 7. Maximum length differential between terminated strands per bundle shall be 6". If the length does not

meet this requirement the entire bundle must be re-terminated.

- C. Slack Loop:
 - 1. Slack loop shall be mounted on the ladder rack.

3.4 IDENTIFICATION:

- A. All fiber optic backbone and riser cables must be labeled with a self-laminating label within 12 inches of the termination.
- B. Fiber enclosures shall have 3/8" to 1/2" high lettering and shall be labeled with the telecommunication room number followed by an alphanumeric character of the rack/cabinet and the enclosure number (i.e. tr1-b-1 represents the first enclosures, second rack/cabinet in telecommunications room #1). Additionally, each strand of fiber shall be identified with the termination location of the opposite end and the fiber position number on the outside (or inside) front cover and top, left-hand corner of the enclosure under the enclosure label.
- C. All cable tags shall be easily accessible, both physically and visually, upon completion of the job.

3.5 GROUNDING & BONDING:

- A. Any use of armored cable shall require the bonding of that shield to the PBB/SBB with a #6 AWG copper bonding conductor.
- B. Refer to Section 27 05 26 for additional details.

3.6 TESTING:

- A. General:
 - 1. The Contractor shall test, as described below, all fiber optic cables installed under these Specifications.
 - 2. Visually inspect all cables, cable reels, and shipping cartons to detect cable damage incurred during shipping and transport. Return visibly damaged items to the manufacturer.
 - 3. Where post-manufacturer test data has been provided by the manufacturer on the reel or shipping carton: submit copies to the Project Technology Designer (Project Electrical Engineer and Registered Communications Distribution Designer (RCDD)) and SDOC Technology Services Department Representative prior to installing cables.
 - 4. Test entire reel fully prior to installation of the product.
 - 5. Test completed systems only. Piecemeal testing is not acceptable.
 - 6. Testing shall not be performed until after all hardware is installed, attached, and all labeling has been completed.
 - 7. Any cable that does not pass all required testing shall be removed, replaced, and retested.
 - 8. Remove and replace any defective cables from pathways system. Do not abandon cables in place.
 - 9. Project Technology Designer (Project Electrical Engineer and Registered Communication Distribution Designer (RCDD)) and SDOC Technology Services Department Representative reserve the right to observe all portions of the testing process.
 - 10. Project Technology Designer (Project Electrical Engineer and Registered Communication Distribution Designer (RCDD)) and SDOC Technology Services Department Representative further reserve the right to conduct "Proof of performance testing", using Contractor equipment and labor, a random re-test of at least ten percent (10%) of the plant cable to confirm documented test results.
 - 11. Perform all tests as required by the manufacturer in support of the structured cabling system warranty.
- B. TESTERS:
 - 1. Optical Time Domain Reflectometer Testing:
 - a) All OTDR testing procedures and field test instruments shall comply with applicable requirements of: TIA/EIA 455-78 and TIA/EIA 455-133

- b) OTDR test jumpers must meet the criteria for reference jumpers specified in TIA/EIA-455-171.
 - c) A launch cable shall be installed between the OTDR and the first link connection.
 - d) A receive cable shall be installed after the last link connection.
 - e) All cables shall be OTDR tested at 850 nm and 1300 nm (for Multi-mode) or at 1310 nm and 1550 nm (single mode) operating wavelengths for anomalies and to ensure uniformity of cable attenuation and connector insertion loss.
 - f) All fiber links shall be tested in both directions.
 - g) Optical Return Loss (ORL) for each link shall be measured.
 - h) Fiber Length shall be measured and documented.
 - i) Perform a high resolution OTDR test with tracing printouts noting each optical fiber and buffer tube color designation.
2. Optical Power Loss Testing:
- a) All fiber optic cables are to be tested via the One-Jumper Reference Method (formerly Method B).
 - b) Perform end-to-end, bi-directional attenuation (loss) test for each fiber strand at 850 nm and 1300 nm (multi-mode) or at 1310 nm and 1550 nm (single mode) wavelengths.
3. Other Tests:
- a) After installation of connectors, visually inspect each fiber end-face at 200x magnification for multimode fiber and 400x magnification for single mode fiber. Refinish fibers with visible defects and / or striations in the core area.
- C. ACCEPTANCE:
1. All test results and corrective procedures are to be documented and submitted in Microsoft Excel or CSV format to the Project Technology Designer (Project Electrical Engineer and Registered Communication Distribution Designer (RCDD)) and SDOC Technology Services Department Representative within five (5) working days of test completion.
2. Each test report shall contain the following general information:
- a) Fiber Inspection Scope
 - b) Date of Preparation
 - c) Date of Test
 - d) Project Name
 - e) Contractor's Name
 - f) Media Type
 - g) Make, Model and Serial Number of test equipment used
 - h) Date of Last Calibration
 - i) Names of Test Crew.
3. Submit the following information regarding the fiber optic cable testing:
- a) Cable Number
 - b) Fiber Count
 - c) Individual Fiber Numbers
 - d) Connector Types
 - e) Number of Connectors / Patches
 - f) Calculated Maximum Link Loss
 - g) Length of Run
 - h) Results of Each Test for Each Fiber
 - i) Measured Link Loss for Each Fiber.

4. Test result shall be recorded per cable and identical copies placed on three removable media devices (USB Flash Drive) for delivery to the Project Technology Designer (Project Electrical Engineer and Registered Communication Distribution Designer (RCDD)) and SDOC Technology Services Department Representative.
 5. Once the testing has been completed and the Project Technology Designer (Project Electrical Engineer and Registered Communication Distribution Designer (RCDD)) and SDOC Technology Services Department Representative are satisfied that all work is in accordance with the Contract Documents, the Representative will notify the Contractor and / or project manager in writing or via email.
- D. RECORD (AS BUILT) DRAWINGS:
1. The Project Record Drawings shall show the types and locations of all optical fiber cabling and termination points. Drawings should include identifying information from the cable identification tags.

END OF SECTION 27 13 23

[REMAINDER OF PAGE INTENTIONALLY LEFT BLANK]

COMMUNICATIONS HORIZONTAL COPPER CABLING

PART 1 GENERAL:

1.1 INTRODUCTION:

A. Horizontal Premise Cable:

1. The work covered by this section of the Specifications includes all labor necessary to perform and complete such construction, all materials and equipment incorporated or to be incorporated in such construction and all services, facilities, tools, and equipment necessary or used to perform and complete such construction. The work of this section shall include, but is not limited to, the following:
 - a) Technology horizontal premise cabling and accessories in accordance with the strictest manufacturer written recommendation per code or the best industry practice. These communication specifications are requirements for all School District of Osceola County (SDOC) projects. Request for deviations from these guides and requirements must be made in writing to the School Board of Osceola County.

1.2 RELATED DOCUMENTS:

A. Division 27 Sections that apply to this Section are:

1. Section 27 00 00 Communications
2. Section 27 05 26 Grounding & Bonding for Communications Systems
3. Section 27 05 28 Pathways for Communications Systems
4. Section 27 05 36 Cable Trays for Communications Systems
5. Section 27 11 10 Telecommunications Spaces, Equipment and Fittings
6. Section 27 13 13 Communications Copper Backbone Cabling
7. Section 27 13 23 Communications Optical Fiber Backbone Cabling
8. Section 27 15 43 Communications Faceplates and Modules
9. Section 27 16 19 Communications Patch Cords and Station Cords
10. Section 27 21 33 Wireless Access Point System
11. Section 27 41 16 Classroom Amplification System
12. Section 27 51 23 Educational Intercom and Program Clock System
13. Section 27 53 21 Distributed Antenna System - Public Safety

1.3 STANDARDS AND CODES:

- A. Refer to other sections in Division 27 00 00 - Communications
- B. Refer to Division 01 - Reference Standards and General Conditions of the Contract
- C. Complies with both ANSI/TIA-607-C and NEC Article 250. The most stringent rules apply.

1.4 APPROVED PRODUCT MANUFACTURERS:

- A. The manufacturer of premise cable systems, that School District of Osceola County is using as basis of design in this document, as required for construction of the cabling infrastructure per contract documents shall be:
 1. Hubbell Premise Wiring
- B. Product substitutions from other manufacturers shall require the approval of the Project Technology Designer (Project Electrical Engineer and Registered Communication Distribution Designer (RCDD)) and SDOC Technology Services Department Representative 10 business days prior to bid opening.

1.5 SUBMITTALS:

A. Shop Drawings:

1. Shop drawings will indicate the location of cable routes, bundle sizes, and penetrations (including cable trays, mechanical firestops, and interior / exterior sleeving), and will require the approval of the Project

Technology Designer (Project Electrical Engineer and Registered Communication Distribution Designer (RCDD)) and SDOC Technology Services Department Representative prior to implementation.

- B. Submit Manufacturer's Cut Sheets for the following (Refer to Section 27 00 00 – Communications Submittal):
 - 1 Major items not included in the Product Section
 - 2 Submit for approval in accordance with specified submittal procedures:
 - a) Cable
 - b) Modular Jacks
 - c) Patch panels
 - d) Faceplates

1.6 QUALITY ASSURANCE:

- A. Manufacturer:
 - 1 Firms regularly engaged in manufacture of the materials, called out for in this section, whose products have been in satisfactory use in similar service for not less than 3 years.
- B. The Contractor will install work in accordance with the latest School District of Osceola County Requirements, the latest BICSI Information Technology Systems Installation Methods Manual, Telecommunications Distribution Methods Manual, TIA/EIA Standard Commercial Building Telecommunications Cabling Standard, systems planning and design manual.
- C. The Contractor who is installing the materials and systems will be trained by the referenced manufacturer in the proper installation practices. The Contractor will have the proper tools and test equipment to ensure a good and proper installation.
- D. Installed UTP cabling systems, pathways and distribution facilities will adhere to manufacturer's instructions, contract drawings and specifications, and applicable codes, standards and regulations.
- E. Installed UTP cabling systems and field test results will strictly adhere to requirements of ANSI/TIA-568-0.D, ANSI/TIA-568-1.D and ANSI/TIA/EIA-568-2.D.
- F. Where applicable, all equipment, components, accessories, and hardware will be UL listed for the intended purpose of the installation.
- G. All critical internal manufacturing operations for installed products will have documented in-process inspection and testing according to ISO9001.
- H. Installed products will be manufactured by an ISO9001 certified facility.
- I. Installed products will be free from defects in material or workmanship from the manufacturer and will be of the quality indicated.
- J. All methods of construction that are not specified in the contract documents will be subject to control and approval by the Project Technology Designer (RCDD) and SDOC Technology Services Department Representative.
- K. Installed products will be lot-traceable by date code.

1.7 DEFINITION:

- A. CMP: Communications Plenum Cable
- B. CMR: Communications Riser Cable

1.8 WARRANTIES:

- A. Refer to Section 27 00 00 for general details

1.9 MATERIALS:

- A. All materials shall be UL or ETL listed and verified and shall be marked as such.
- B. Products shall be regularly catalogued items of the manufacturer and shall be supplied as a complete unit in accordance with the manufacturer's standard specifications with any optional items required for proper installation unless otherwise noted.
 - 1 All materials used on this project shall be new. Used and refurbished equipment are not permitted. Provided equipment on site in original packaging whenever practical.

1.10 DELIVERY, STORAGE AND HANDLING LOGISTICS:

- A. Material shall be delivered to the site in the original packing.
- B. Materials delivered to the construction site shall be stored in a dry, secure area, preferably indoors. Storage temperature of materials shall adhere to manufacturer's recommendations. Movement of packaged materials shall be in a manner to avoid damage of contents. On-site storage, either indoors or trailer, shall have permission by the School District of Osceola County Staff, and shall not interfere with other construction activity.
- C. Installation of Category 5e, Category 6 or Category 6a cable shall be within the recommended temperature range specified by the manufacturer. Cable installation temperature range between 50°f and 80°f is recommended. Cabling should only be installed in facilities that are not exposed to the elements.
- D. The Contractor is responsible for scheduling all deliveries and providing proper receipt, handling, and storage of all materials. Protect all equipment from physical damages (dents, scratches, dust, water, **paint**, chemicals, and temperature extremes) and vandalism, or theft. The Contractor shall replace any damaged or stolen equipment. The Contractor is responsible for all equipment until final project acceptance by the School District of Osceola County.
- E. The Contractor is responsible for cleaning the worksite every business day and removing debris from the facility.

1.11 COORDINATION WITH OTHER TRADES:

- A. Coordinate layout of work with other trades. Make minor adjustments in locations required for coordination. Locations of structural systems, heating work and plumbing lines shall take preference over locations of conduit lines where conflict occurs. Structural systems, heating work, and plumbing lines shall not interfere with or otherwise impede the routing of communication cabling with cable tray, raceways, or other pathways dedicated to communications. All potential issues shall be brought to the attention of the General Contractor, Construction Manager, Architect, Engineer, Project Technology Designer (RCDD), The School District of Osceola County and SDOC Technology Services Department Representative immediately before proceeding with installation.
- B. Other than minor issues, adjustments shall be submitted to the General Contractor, Construction Manager, Architect, Engineer, Project Technology Designer (RCDD), and SDOC Technology Services Department Representative for approval before proceeding with the work.
- C. Coordinate locations, arrangement, mounting, and support of all communications provisions with Division 26 Representative, Project Technology Designer (RCDD), and SDOC Technology Services Department Representative that:
 - 1. Allow maximum possible headroom unless specific mounting heights that reduce headroom are indicated
 - 2. Provide for ease of disconnecting the equipment with minimum interference to other installations
 - 3. Allow right of way for piping and conduit installed at required slope
 - 4. Coordinate that raceways, cables, and cable trays will be clear of obstructions and of the working and access space of other equipment
 - 5. Coordinate installation of required supporting devices and set sleeves in cast-in-place concrete, masonry walls, and other structural components as they are constructed
 - 6. Coordinate sleeve selection specified in Division 07 and Division 26
 - 7. Coordinate location of access panels and doors for electrical items that are behind finished surfaces or otherwise concealed
 - 8. Coordinate the gauge cables to be used in the telecommunications grounding system
- D. Low Voltage Contractor shall furnish and install the following:
 - 1. Patch Panels
 - 2. Cable, Copper
 - 3. Modular Jacks
 - 4. Face Plates
- E. Electrical Contractor shall furnish and install the following:
 - 1. Conduit

2. Outlet Boxes
 3. Penetrations
 4. Mechanical Firestop devices
 5. Sleeving (rated / non-rated barriers)
- F. Unless noted otherwise, the following items will be the responsibility of the School District of Osceola County:
1. All electronics and active data networking equipment, etc.
 2. Telephones, etc.
 3. PC's, printers, video display terminals (desktop), flat panel displays (desktop), etc.

PART 2 PRODUCTS:

2.1 CABLES:

A. Category 5e UTP:

1. 4-pair, category 5e, unshielded twisted pairs (UTP), 22 AWG, bare copper, polyethylene insulated conductors, with overall Green Jacket (Media / Intercom applications):
 - a) Conductor: 22 awg solid bare copper
 - b) 1 GB Application
 - c) Maximum bandwidth 190 MHz
 - d) PoE, PoE+ and 4PPoE
 - e) Cables shall be terminated on modular jacks in equipment frames unless otherwise noted (U.O.N.)

B. Category 6 UTP:

- a) 4-pair, category 6, unshielded twisted pairs (UTP), 23 AWG, bare copper, polyethylene insulated conductors, with overall Yellow Jacket (General Data):
 - b) Rate to 550 MHz
 - c) TIA PARAMETER HEADROOM
 - d) NEXT loss +3 dB
 - e) PSNEXT loss +3 dB
 - f) ACRF +3 dB
 - g) PSACRF +3 dB
 - h) PoE, PoE+
 - i) TIA Component Compliant
 - j) Cables shall be terminated on modular jacks in equipment frames

C. Category 6 OSP:

1. Suitable for direct burial, lashed aerial, duct and underground conduit
 - a) UV resistant jacket

D. Category 6A UTP:

1. 4-pair, category 6A, unshielded twisted pairs (UTP), 24-gauge, bare copper, polyethylene insulated conductors, with overall Yellow Jacket (General data applications):
 - a) Conductor: 23 awg solid bare copper
 - b) 10GbE Application Assurance
 - c) Maximum bandwidth beyond 750 MHz
 - d) TIA Component Compliant ANEXT Performance
 - e) PoE, PoE+ and 4PPoE – 100 Watt

2.2 PATCH PANEL:

- A. UTP Patch Panels, Category 6A (Premise Distribution System):
 - 1. Panel shall be constructed of 16-gauge steel, rolled edge construction with black powder coat finish
 - 2. Panel shall be standard 19-inch rack mount
 - 3. Panels comply with EIA-310-D rack mount standards
- B. UTP Patch Panels, Category 6 (Intercom / BAS Systems):
 - 1. Panel shall be constructed of 16-gauge steel, rolled edge construction with black powder coat finish
 - 2. Panel shall be standard 19-inch rack mount
 - 3. Panels comply with EIA-310-D rack mount standards

2.3 MODULAR JACK:

- A. Category 5e:
 - 1. Jacks shall be standard 8-position, RJ-45 style, un-keyed, FCC Compliant
 - 2. Each jack shall be single unit construction, with snap – fit to industry standard keystone opening (.760" x .580")
 - 3. Jack housings shall be high impact UL 94 v-0 rated thermoplastic
 - 4. Jacks shall have a temperature rating of -10^oc (14^{of}) to 70^oc (158^{of})
 - 5. Jack housings shall fully encase and protect printed circuit boards and IDC fields
 - 6. Housings shall be ultrasonically welded for tamper resistance
 - 7. Modular jack contacts shall accept a minimum of 2000 mating cycles without degradation of electrical or mechanical performance
 - 8. Jack contacts shall maintain a minimum deflection force of 100 grams while mated with an FCC-standard RJ-45 plug
 - 9. Jack contacts shall be formed flat for increased surface contact with mated plugs
 - 10. Jack contacts shall be constructed of beryllium copper for maximum spring force and durability. Contact plating shall be a minimum of 50 micro-inches of hard gold in the contact area over 50 micro-inches of nickel
 - 11. Jack termination method shall follow the industry standard 110 IDC punch-down. Jacks shall be compatible with single conductor standard 110 impact termination tools
 - 12. Jacks shall be compatible with a 4-pair single punch impact tool designed specifically for the purpose
 - 13. Jacks shall have their category rating designation, visible from the front when installed
 - 14. Bottom of jack shall have date code and an abbreviated catalog number
 - 15. Jacks shall terminate 26-22 awg solid conductors
 - 16. Jacks shall not require special cords, specialty tools or special installation requirements
 - 17. Stuffer cap shall have retention snaps to assure conductor strain relief
 - 18. Jacks shall accept optional hinged dust covers
 - 19. Jacks shall be compatible with ANSI/TIA-606-B color code labeling
 - 20. Jacks shall accept snap-on icons for specific identification
 - 21. Jacks shall be available in various colors to meet specific customer applications
 - 22. Jacks shall have attached wiring instruction labels to permit T568a wiring configurations
 - 23. Category rated jacks shall be backward compatible for fit, form, and function
 - 24. Jacks shall be **manufactured in the USA**
 - 25. All transmission performance parameters shall be independently verified by a UL or ETL third party testing organization
 - 26. Jacks shall be UL listed 1863 and CSA certified

27. Jacks shall exceed IEEE 802.3af DTE power specification to 4 times the rated current limits with no degradation of performance or materials
 28. Jacks shall exceed IEEE802.3bt DTE power specification
 29. Jacks shall be third party verified, to meet or exceed performance requirements
 30. Component rated per ANSI/TIA-568.2-D
 31. Colors to specified by end user
- B. Category 6:
1. Jacks shall be standard 8-position, RJ-45 style, un-keyed, FCC compliant
 2. Each jack shall be single unit construction, with snap – fit to industry standard keystone opening (.760” x .580”)
 3. Jack housings shall be high impact UL 94 v-0 rated thermoplastic
 4. Jacks shall have a temperature rating of -10°C (14°F) to 70°C (158°F)
 5. Jack housings shall fully encase and protect printed circuit boards and IDC fields
 6. Housings shall be ultrasonically welded for tamper resistance
 7. Modular jack contacts shall accept a minimum of 2000 mating cycles without degradation of electrical or mechanical performance
 8. Jack contacts shall maintain a minimum deflection force of 100 grams while mated with an FCC-standard RJ-45 plug
 9. Jack contacts shall be formed flat for increased surface contact with mated plugs
 10. Jack contacts shall be constructed of beryllium copper for maximum spring force and durability. Contact plating shall be a minimum of 50 micro-inches of hard gold in the contact area over 50 micro-inches of nickel
 11. Jack termination method shall follow the industry standard 110 IDC punch-down. Jacks shall be compatible with single conductor standard 110 impact termination tools
 12. Jacks shall be compatible with a 4-pair single punch impact tool designed specifically for the purpose
 13. Jacks shall have their category rating designation, visible from the front when installed
 14. Bottom of jack shall have date code and an abbreviated catalog number
 15. Jacks shall terminate 26-22 awg solid conductors
 16. Jacks shall not require special cords, specialty tools or special installation requirements
 17. Stuffer cap shall have retention snaps to assure conductor strain relief
 18. Jacks shall accept optional hinged dust covers
 19. Jacks shall be compatible with ANSI/TIA-606-B color code labeling
 20. Jacks shall accept snap-on icons for specific identification
 21. Jacks shall be available in various colors to meet specific customer applications
 22. Jacks shall have attached wiring instruction labels to permit T568a wiring configurations
 23. Category rated jacks shall be backward compatible for fit, form, and function
 24. Jacks shall be **manufactured in the USA**
 25. All transmission performance parameters shall be independently verified by a UL or ETL third party testing organization
 26. Jacks shall be UL listed 1863 and CSA certified
 27. Jacks shall exceed IEEE 802.3af DTE power specification to 4 times the rated current limits with no degradation of performance or materials
 28. Jacks shall exceed IEEE802.3bt DTE power specification
 29. Jacks shall be third party verified, to meet or exceed performance requirements

30. Component rated per ANSI/TIA-568.2-D
31. Colors to specified by end user

C. Category 6A

1. Jacks shall be standard 8-position, RJ-45 style, un-keyed, FCC compliant
2. Each jack shall be single unit construction, with snap – fit to industry standard keystone opening (.760” x .580”)
3. Jack housings shall be high impact UL 94 v-0 rated thermoplastic
4. Jacks shall have a temperature rating of -10°C (14°F) to 70°C (158°F)
5. Jack housings shall fully encase and protect printed circuit boards and IDC fields
6. Housings shall be ultrasonically welded for tamper resistance
7. Modular jack contacts shall accept a minimum of 2000 mating cycles without degradation of electrical or mechanical performance
8. Jack contacts shall maintain a minimum deflection force of 100 grams while mated with an FCC– standard RJ-45 plug
9. Jack contacts shall be formed flat for increased surface contact with mated plugs
10. Jack contacts shall be constructed of beryllium copper for maximum spring force and durability. Contact plating shall be a minimum of 50 micro-inches of hard gold in the contact area over 50 micro- inches of nickel
11. Jack termination method shall follow the industry standard 110 IDC punch-down. Jacks shall be compatible with single conductor standard 110 impact termination tools
12. Jacks shall be compatible with a 4-pair single punch impact tool designed specifically for the purpose
13. Jacks shall have their category rating designation, visible from the front when installed
14. Bottom of jack shall have date code and an abbreviated catalog number
15. Jacks shall terminate 26-22 awg solid conductors
16. Jacks shall not require special cords, specialty tools or special installation requirements
17. Stuffer cap shall have retention snaps to assure conductor strain relief
18. Jacks shall accept optional hinged dust covers
19. Jacks shall be compatible with ANSI/TIA-606-B color code labeling
20. Jacks shall accept snap-on icons for specific identification
21. Jacks shall be available in various colors to meet specific customer applications
22. Jacks shall have attached wiring instruction labels to permit T568a wiring configurations
23. Category rated jacks shall be backward compatible for fit, form, and function
24. Jacks shall be **manufactured in the USA**
25. All transmission performance parameters shall be independently verified by a UL or ETL third party testing organization
26. Jacks shall be UL listed 1863 and CSA certified
27. Jacks shall exceed IEEE 802.3af DTE power specification to 4 times the rated current limits with no degradation of performance or materials
28. Jacks shall exceed IEEE802.3bt DTE power specification
29. Jacks shall be third party verified, to meet or exceed performance requirements
30. Component rated per ANSI/TIA-568.2-D
31. Colors specified by end user

2.4 FACE PLATES:

- A. Rear loading w/designation window:
 - 1. Faceplates shall be constructed of high impact, UL94 v-0 rated thermoplastic
 - 2. Faceplates shall be compatible with standard NEMA openings and boxes. Faceplates shall be 2.75" w x 4.5" h (69.8 mm x 114.3 mm) for single gang and 4.5" x 4.5" (114.3 x114.3 mm) for double gang
 - 3. Port size in each faceplate shall fit the category 6 modular jack or snap-fit fiber optic, audio, and video modules for multimedia applications
 - 4. Faceplates shall be provided with clear plastic and color-matched label field covers. Faceplates shall provide for ANSI/TIA-606-B compliant workstation outlet labeling
 - 5. #6-32 pan head Philips / slotted mounting screws shall be included with each faceplate
 - 6. Faceplates shall be **manufactured in the USA**
 - 7. Faceplates shall be UL listed and CSA certified
 - 8. Colors specified by end user

PART 3 EXECUTION:

3.1 Installation:

- A. Cable Support:
 - 1. This Contractor shall install all supports for cables specified in this section. Traditional ladder rack will be used in each telecommunications room, basket tray (main pathway, over 25 cables), and j-hooks will be used in the horizontal.
 - 2. Cable supports shall be spaced randomly, but no further than 5'-0" apart.
 - 3. Provide all additional cable management products, sleeves or conduit raceways as required to protect exposed cabling and complete the installation of cables in a neat manner.
 - 4. A horizontal conduit system consists of conduits radiating from the telecommunications location to the workstation outlets in the floor, walls, ceilings, and columns of a building. When using a conduit distribution system utilize the most direct route following the building lines.
 - 5. Conduit is only required if building codes or environmental conditions necessitate it. Rigid or EMT metal conduits are deemed suitable for building installation. Adequate planning should allow for a minimum of one 1-1/4-inch conduits to each workstation location if code requires conduit for voice and data cables.
 - 6. Conduit fill ratios shall not exceed 40%; contact your cable manufacturer to get recommendation on fill rates.
 - 7. No conduit run should be designed with more than two (2) 90-degree bends between pull points or pull boxes. If a run requires more than two (2) 90-degree bends, install a pull box:
 - a) Exceptions:
 - 1) The total run is shorter than 33 ft in length
 - 2) The conduit size is increased to the next trade size
 - 3) One of the bends is located within 12 in of the cable feed end. (This exception only applies to operations where cable is pushed around the first bend)
 - 8. All conduits will be equipped with a contiguous length of plastic or nylon pull string with a minimum rating of 200 lbs. (90 kg).
 - 9. A conduit run should not be designed with continuous closed sections longer than 100 feet without pull points or pull boxes installed:
 - a) Exceptions:
 - 1) Exterior conduit installation is between buildings / vaults
 - 10. All conduits should terminate above or in the installed ladder racks and allow for proper cable racking. Cable waterfalls should be considered in areas that have excessive distance between the conduit and ladder rack.
 - 11. Trays and conduits located within the ceiling shall protrude into the room 1 to 2 inches without a bend

and above 8 feet high. Clear, unobstructed access to the ladder rack and conduits shall be provided within telecommunications locations.

12. Conduits entering through the floor shall terminate at least six (6) inches above the finished floor (A.F.F.).
13. Locate slot / sleeve systems in places where pulling and termination will be easy.
14. If possible, locate sleeves, slots, and / or conduits on the left side of the room; this placement enhances the use of wall space from left to right.
15. When possible, entrance conduit and distribution conduit / cable tray should enter and exit on the same wall, if this is not possible, ladder rack inside the room should be provided for distribution from wall to wall.
16. All floor penetrations shall be core drilled with a maximum 1/4-inch size greater than the exterior dimension of the riser conduit.
17. Conduits entering through a wall shall be reamed and bushed and terminated as close as practicable to the terminating rack or wall.
18. Terminations above a suspended ceiling shall not be less than 3 inches above finished ceiling and finished with bushing opening.
19. All conduit shall be labeled for easy identification.
20. All floor penetrations shall be at columns, exterior walls or in equipment rooms.
21. Cables shall be supported at height of bottom flange of structural beams using a rigid support method (i.e. threaded rod, beam clamps, etc.).
22. Do not support cables from ductwork, sprinkler piping, water piping, waste piping, conduit, ceiling wire, or other system supports.
23. The conduits or sleeve will be installed per TIA/EIA-569-C and seal all penetration with approved fire stop product.
24. Provide and identify independent support system for each low voltage cabling system.

B. Cable:

1. Category 6 or Category 6a cable (yellow in color) will be utilized for all data communication systems.
2. Category 6 or Category 6a gel filled cable will be utilized in areas where the cable pathway is in or below the floor that is in contact with dirt or gravel. Certain environments may require the use of different cables and / or cable jackets.
3. All premise cabling systems shall be terminated in either a keystone data outlet or a keystone patch panel location – no termination shall be utilized to directly connect any premise cabling to any network components, hardware, or devices (exception: exterior camera locations) unless otherwise noted (U.O.N.).
4. PE 89 (outside plant telephone cable) six (6) pair will be utilized for backbone cabling between building unless otherwise noted (U.O.N.).
5. All terminations will utilize T568a wiring in School District of Osceola County Facilities. Any Contractor not complying with this wiring requirement will correct the problem at no cost to School District of Osceola County.
6. All communications cabling that has become abandoned as part of new renovation projects, previous renovation projects, or temporary communication cables used during the construction process shall be completely removed.
7. Refer to detailed manufacturer's guidelines for deployment of Category 6 or Category 6a cable. Certain restrictions apply, and specific techniques are recommended.
8. All cabling shall be installed in accordance with manufacturers' written bend radius and pulling tensions. Typical industry guidelines recommend the following bend radius and pulling tensions:
 - a) Tensile loading on a single 4-pair copper UTP cable shall not exceed 25 lbs.
 - b) Bend radius of a single 4-pair copper UTP cable shall not exceed 4 times the diameter of the cable
 - c) Bend radius of multi-pair copper UTP and optical fiber cable shall not exceed 10 times the diameter of the cable
9. All conduits and conduit sleeves shall have bushings or grommets and shall be installed prior to the

installation of communications cables to avoid damage and abrasions to cable sheathing and insulation. If the electrical Contractor does not install bushings, the communications cabling contractor shall furnish and install bushings prior to pulling communications cabling.

10. Horizontal cable length for 4-pair copper UTP cables shall not exceed 295 feet (90 meters). Prior to bidding and installation, the contractor shall review the drawings and verify no cable installation exceeds 295 feet (90 meters) and notify the Project Technology Designer (Project Electrical Engineer and Registered Communication Distribution Designer (RCDD)) and SDOC Technology Services Department Representative of cable installations that may exceed 295 feet (90 meters).
 11. Splices are not permitted in any voice or data cable.
 12. Avoid placing copper cables near sources of extreme heat (i.e. boilers, radiators, heat coils).
 13. Maintain cable twists for all UTP cables. For terminations cable sheathing shall be stripping back no more than ½" back from termination point for all Category 6 and Category 6a cables.
 14. All cables shall be supported by cable tray, cable runway, or j-hooks. When large quantities of cables leave trays or runways, cables shall be supported by drop-outs or cable support hardware manufactured specifically for the purpose of supporting cables. J-hooks shall be installed a minimum of every 5 feet and cabling shall maintain minimal deflection and strain (less than 12" deflection). Cables shall not be supported from ceiling grid wires. Cables shall not run above iron joists.
 15. All cables shall be separated and bundled into like groups (disciplines).
 16. Service loops shall be provided at both ends of installed horizontal and backbone cabling:
 - a) A three (3) foot service loop shall be installed in the ceiling space near workstation outlets (excessive cable shall not be coiled in outlet boxes)
 - b) A ten (10) foot service loop shall be provided in communication rooms and shall be installed to allow for future equipment rack / cabinet relocations without the need to re-terminate patch panels:
 - 1) The ten (10) foot service loop shall be neatly bundled and secured in cable trays. Additional Cable slack and service coils shall be stored properly above the ceiling or under the access floor (where applicable)
 17. Any cabling installing in equipment rooms shall be neatly placed in cabling trays, cabling runways, or horizontal and vertical rack / cabinet cable managers.
 18. Velcro straps shall be utilized in the CD, FD, TR and inside TC enclosures for all cable bundling. Tie wraps are prohibited – NO EXCEPTIONS.
- C. Separation:
1. Maintain the following distances between cables, other system cables and other building systems:
 - a) Two (2) feet from fluorescent lights
 - b) Two (2) feet from power cabling in parallel
 - c) Two (2) feet from electrical conduits, other systems cables or other electrical equipment
 - d) Four (4) feet from motors and transformers
 - e) Three (3) feet from hot water piping or other mechanical equipment
 - f) Ten (10) feet from bus conductors or high-current branch circuits
 2. All low voltage cables shall run parallel or at right angles to building structural framework. Do not run cables diagonally across ceiling space without written authorization by the Technology Project Designer (Project Electrical Engineer and Registered Communication Distribution Designer (RCDD)) and SDOC Technology Services Department Representative.
 3. Communications cabling that must cross power cables or conduits shall cross at a 90-degree angle and shall not make physical contact.
 4. Fire seal around all cables running through rated floors and walls. Firestop all cables and pathways that penetrate fire-rated barriers using approved methods and in accordance with local codes.
 5. Provide a pull string with every outlet installed.
 6. Do not install cable in wet areas, or in proximity to hot water pipes or boilers.

7. Cable ends for termination shall be clean and free from crush marks, cuts, or kinks left from pulling operations. Installed cable jackets shall have no abrasions with exposed conductor insulation or bare copper "shiners". The installer is responsible to replace damaged cables.
8. Backbone cables shall be installed and bundled separately from horizontal distribution cables. Backbone and horizontal cable bundles shall be loose and random.
9. Backbone cables spanning more than three floors shall be supported at the top of the cable run with a wire mesh grip and on alternating floors, unless otherwise specified by local codes or manufacturer's guidelines.
10. Vertical runs of backbone cables entering each telecommunication location shall be securely fastened along a properly prepared wall in the telecommunication location on each floor. Use of cable ladder is recommended.

D. Communications infrastructure:

1. Horizontal cable length for 4-pair copper UTP cables shall not exceed 295 feet (90 meters). Prior to bidding and installation, the contractor shall review the drawings and verify no cable installation exceeds 295 feet (90 meters) and notify the Project Technology Designer (Project Electrical Engineer and Registered Communication Distribution Designer (RCDD)) and SDOC Technology Services Department Representative of cable installations that may exceed 295 feet (90 meters).
2. Support and secure cables at patch panels using rear cable management bracket, spools, or management devise.
3. Install category 3, multi-pair voice backbone cables utilizing an independent open cabling. This may require gelled filled cable for under slab installations.
4. For each voice cross-connect; provide the appropriate color icon at each patch panel port at the telecommunication locations.
5. Complete all cross-connects for analog central office facilities and alarm lines to 66-termination block (if applicable).
6. Cross-connects shall be completed as per construction schedule.

E. Category 6 jacks:

1. Refer to specific manufacturer's guidelines for termination of jacks and dressing category 6 cables inside wall outlets and surface housings. Due to the larger size of category 6 cable, service coils in outlet boxes and surface housings are not recommended.
2. Terminate jacks according to manufacturer's instructions.
3. All jacks shall be wired utilizing T568a wiring scheme.
4. To assure 10G Base-T performance, maintain wiring pair twists as close as possible to the point of termination. Also, minimize the length of exposed pairs from the jacket to the IDC termination point during installation.
5. The length of wiring pair un-twist in each termination shall be less than 0.5 inches (13 mm).
6. Jacks shall be properly mounted in plates, frames, or housings with dust caps fully installed over IDC contacts.
7. Horizontal cables extending from mounted jacks shall maintain a minimum bend radius of at least 4 times the cable diameter unless space is restricted.
 - a) Note: refer to specific manufacturer's recommendations for restricted cable bend radius.
8. Cable terminations shall minimize tensile or bending strain on IDC contacts after assembly of faceplate or housing to the wall outlet.

F. Category 6 patch panels:

1. Properly mount patch panels into the designated rack, cabinet, or bracket locations with the #12-24 screws provided.
 - a) Install patch panel screws utilizing a #3 phillips head screwdriver to avoid stripping screw during installation or removal
2. Terminate cables behind the patch panel according to manufacturer's instructions.
3. To assure required performance, maintain wiring pair twists as close as possible to the point of

termination. Also, minimize the length of exposed pairs from the jacket to the IDC termination point during installation.

4. The length of wiring pair un-twist in each termination shall be less than 0.5 inches (13 mm) and shall be kept to a minimum.
5. Each terminated and dressed cable shall be maintained perpendicular to the rear cover using the recommended cable management hardware.
6. Horizontal or backbone cables extending from the rear panel terminations shall maintain a minimum bend radius of at least 4 times the cable diameter.
7. Cable terminations shall have minimal tensile or bending strain on panel IDC contacts in each installed location.
8. Panels shall be properly labeled on the front and back with the cable number and port connections for each port.
9. Patch panel jacks shall match color of patch cords (exceptions – telecommunication outlets (D1-D8) shall be black in color).

G. Fire stop:

1. Before beginning installation, verify that substrate conditions previously installed under other sections are acceptable for installation of firestopping in accordance with manufacturer's installation instructions and technical information.
2. Surfaces shall be free of dirt, grease, oil, scale, laitance, rust, release agents, water repellants, and any other substances that may inhibit optimum adhesion.
3. Provide masking and temporary covering to protect adjacent surfaces.
4. Do not proceed until unsatisfactory conditions have been corrected.
5. Install through-penetration firestop systems in accordance with performance criteria and in accordance with the conditions of testing and classification as specified in the published design.
6. Comply with manufacturer's instructions for installation of firestopping products.
7. Keep areas of work accessible until inspection by authorities having jurisdiction. Where deficiencies are found, repair firestopping products so they comply with requirements.
8. Remove equipment, materials, and debris. Leave area in undamaged and clean condition.
9. Clean all surfaces adjacent to sealed openings to be free of excess firestopping materials and soiling as work progresses.

3.2 LABELING:

A. General:

1. All labels shall be permanent, machine generated labels produced by a labeling machine. Labels shall be a permanent polyester material clear in color with label lettering black in color. No handwritten labels will be accepted.
2. Labeling information will be reviewed at pre-installation meeting, and the Project Technology Designer (RCDD), and SDOC Technology Services Department Representative shall approve the labeling scheme prior to the installation of any cabling.
3. Surfaces shall be cleaned before attaching labels. All labels shall be attached firmly and vertically plumb on equipment, faceplates, patch panels termination blocks, etc.
4. All labeling of cables, equipment, and components shall be included in as-built documentation, floor plan drawings, and schematic designs.

B. Cabling:

1. All structured cables (horizontal and backbone) shall be labeled at both ends within 6" of cable termination point. Where voice backbone cables extend behind termination blocks, cable labels shall be placed at a location on the cable where the labels are visible from the front of the termination blocks.
2. Labels shall have an adhesive backing and shall wrap completely around the circumference of the cable jacket. Label and lettering sizes shall be of appropriate size to accommodate cable diameter.

- C. Equipment racks, termination hardware, and faceplates:
1. All communications equipment racks, cabinets, fiber enclosures, and termination hardware shall be clearly labeled at the top, left-hand corner of the equipment.
 2. Equipment racks and cabinets shall have $\frac{3}{4}$ " to 1" high lettering and shall be labeled with the telecommunications room number followed by an alphanumeric character in sequence for each rack / cabinet. (i.e. Tr2-a represents the first rack/cabinet in telecommunications room #2).
 3. Modular patch panels shall have $\frac{3}{8}$ " to $\frac{1}{2}$ " high lettering and shall be labeled with the telecommunications room number followed by an alphanumeric character of the rack / cabinet and the patch panel number (i.e. Tr3-c-2) represents the second patch panel, third rack/cabinet in telecommunications room #3):
 - a) Patch panels shall be labeled with sequential numbering starting with "01" for topmost patch panel and moving downward towards the bottom of the rack. Additionally, each jack position on the patch panel shall be identified with the jack position number (i.e. A 48-port patch panel shall have number 1 through 48 silk screen printed on the patch panel or shall have labeling strips with numbers 1 through 48 machine printed above / below corresponding jack position).
 4. Voice and data outlets shall have $\frac{3}{16}$ " high lettering with the labeling method as indicated:
 - a) Voice and data outlets shall be identified with the telecommunications room where cables are terminated, the rack / cabinet number, the patch panel number, and the jack position number (i.e. TR3-C2-28 represents the outlet is located on the second patch panel in the third rack/cabinet in telecommunications room #3 and is jack position #28). The Contractor shall terminate all cabling in a sequential method.

PART 4 TESTING:

4.1 CATEGORY CABLE TESTING:

- A. Permanent link testing shall be completed on all horizontal (station) cables:
1. Category rated cabling systems shall be tested as an installed horizontal permanent link configuration. Jacks and faceplates shall be assembled complete and properly mounted into outlet boxes. Panels shall be terminated completely and fully dressed with proper cable management.
 2. All wiring shall be certified to meet or exceed the specifications as set forth in ANSI/Tia-568.0-D.
 - a) Field testing shall include the following parameters for each pair of each cable installed:
 - 1) Name of the person performing the test
 - 2) Test equipment manufacturer and model number
 - 3) Cable identification of the test sheets will be in numerical order by cable identification
 - 4) Date of test
 - 5) Wire map (pin to pin connectivity and polarity check)
 - 6) Length (in feet)
 - 7) Insertion loss
 - 8) Near end crosstalk (next)
 - 9) Power sum near end crosstalk (psnext)
 - 10) Equal-level far end crosstalk (elfext)
 - 11) Power sum equal-level far end crosstalk (pselfext)
 - 12) Return loss
 - 13) Delay skew
 - 14) Attenuation to crosstalk ratio (acr)
 3. A "pass" indication shall be obtained for each link, using at minimum a level iii tester that complies with ANSI/TIA-568.0-D field test requirements.
 4. Record test results for each cable and turn over to the General Contractor upon completion of the job. Correct malfunctions when detected, and re-test to demonstrate compliance.
 - a) Note: Test equipment shall be a type IV cable tester

5. Performance testing (100%) of all horizontal copper cabling shall be conducted by Project Technology Designer (Electrical Engineer and Registered Communications Distribution Designer (RCDD)) and Premise Contractor prior to Substantial Completion acceptance and said test results forwarded to Project Technology Designer (RCDD), and SDOC Technology Services Department Representative, in writing, containing original test results for project manager / owner Representative approval.
6. Performance testing (100%) of all Fiber Optic cabling, both single mode and multi-mode cabling, shall be conducted by Project Technology Designer (Electrical Engineer and Registered Communications Distribution Designer (RCDD)) and Premise Contractor prior to Substantial Completion acceptance and said test results forwarded to Project Technology Designer (RCDD), and SDOC Technology Services Department Representative, in writing, containing original test results for project manager / owner Representative approval.

END OF SECTION 27 15 13

[REMAINDER OF PAGE INTENTIONALLY LEFT BLANK]

SECTION 27 15 43

COMMUNICATIONS FACEPLATES AND MODULES

PART 1 GENERAL:

1.1 INTRODUCTION:

A Faceplates and Modules:

1. The work covered by this section of the Specifications includes all labor necessary to perform and complete such construction, all materials and equipment incorporated or to be incorporated in such construction and all services, facilities, tools, and equipment necessary or used to perform and complete such construction. The work of this section shall include, but is not limited to, the following:

B Telecommunication faceplates, jacks, outlet modules, cabling, and accessories in accordance with the strictest manufacturer written recommendation per code or the best industry practice. These communication specifications are requirements for all School District of Osceola County (SDOC) projects. Request for deviations from these guides and requirements must be made in writing to the School Board of Osceola County.

1.2 RELATED DOCUMENTS:

A Division 27 Sections that apply to this Section are:

- | | | |
|-----|------------------|--|
| 1. | Section 27 00 00 | Communications |
| 2. | Section 27 05 26 | Grounding & Bonding for Communications Systems |
| 3. | Section 27 05 28 | Pathways for Communications Systems |
| 4. | Section 27 05 36 | Cable Trays for Communications Systems |
| 5. | Section 27 11 10 | Telecommunications Spaces, Equipment, and Fittings |
| 6. | Section 27 13 13 | Communication Copper Backbone Cabling |
| 7. | Section 27 13 23 | Communications Optical Fiber Backbone Cabling |
| 8. | Section 27 15 13 | Communications Copper Horizontal Cabling |
| 9. | Section 27 16 19 | Communications Patch Cords and Station Cords |
| 10. | Section 27 21 33 | Wireless Access Point System |
| 11. | Section 27 41 16 | Classroom Amplification System |
| 12. | Section 27 51 23 | Educational Intercom and Program Clock System |
| 13. | Section 27 53 21 | Distributed Antenna System – Public Safety |

1.3 STANDARDS AND CODES:

- A Refer to other sections in Division 27 00 00 – Communications
- B Refer to Division 01 – Reference Standards and General Conditions of the Contract
- C Complies with both ANSI/TIA-607-C and NEC Article 250. The most stringent rules apply.

1.4 APPROVED PRODUCT MANUFACTURERS:

- A The manufacturer of the faceplates and modules, that School District of Osceola County is using as basis of design in this document, as required for construction of the cabling infrastructure per contract documents shall be:
1. Hubbell Premise Wiring
- B Product substitutions from other manufacturers shall require the approval of the Project Technology Designer (Project Electrical Engineer and Registered Communication Distribution Designer (RCDD)) and SDOC Technology Services Department Representative 10 business days prior to bid opening.

1.5 SUBMITTALS:

- A Shop Drawings:
 - 1. Shop drawings will indicate the location and quantity of faceplate and modules (including number of data jacks) and will require the approval of the Project Technology Designer (Project Electrical Engineer and Registered Communication Distribution Designer (RCDD)) and SDOC Technology Services Department Representative prior to implementation.
- B Submit Manufacturer's Cut Sheets for the following (Refer to Section 27 00 00 – Communications Submittal):
 - 1. Major items not included in the Product Section.
 - 2. Submit for approval in accordance with specified submittal procedures:
 - a) Faceplates
 - b) Modules
 - c) Jacks

1.6 QUALITY ASSURANCE:

- A Manufacturer:
 - 1. Firms regularly engaged in manufacture of the materials, called out for in this section, whose products have been in satisfactory use in similar service for not less than 3 years.
- B The Contractor will install work in accordance with the latest School District of Osceola County Requirements, the latest BICSI Information Technology Systems Installation Methods Manual, Telecommunications Distribution Methods Manual, TIA/EIA Standard Commercial Building Telecommunications Cabling Standard, systems planning and design manual.
- C The Contractor who is installing the materials and installing the system will be trained by the referenced manufacturer in the proper installation practices. The Contractor will have the proper tools and test equipment to insure a good and proper installation.
- D Installed UTP and fiber cabling systems, pathways, and distribution facilities will adhere to manufacturer's instructions, contract drawings and specifications, and applicable codes, standards, and regulations.
- E Installed UTP cabling systems and field test results will strictly adhere to requirements of ANSI/TIA-568-0.D, ANSI/TIA-568-1.D and ANSI/TIA/EIA-568-2.D.
- F Installed optical fiber cabling systems and field test results will strictly adhere to requirements of ANSI/TIA-568-0.D and ANSI/TIA/EIA-568-3.D.
- G Where applicable, all equipment, components, accessories, and hardware will be UL listed for the intended purpose of the installation.
- H All critical internal manufacturing operations for installed products will have documented in-process inspection and testing according to ISO9001.
- I Installed products will be manufactured by an ISO9001 certified facility.
- J Installed products will be free from defects in material or workmanship from the manufacturer and will be of the quality indicated.
- K All methods of construction that are not specified in the contract documents will be subject to control and approval by the Project Technology Designer (RCDD) and SDOC Technology Services Department Representative.
- L Installed products will be lot-traceable by date code.

1.7 DEFINITION:

- A Jack:
 - 1. Termination point for telecommunications cabling that transitions from permanently installed station cable to a user end station cord. Also referred to as an "Information Outlet"

- B Faceplate:
 1. Any type of plastic or metal plate designed to fit over a device or computer component to enhance the device's functionality or its looks. Also referred to as "Outlet Cover".
- C Module:
 1. A Standardized snap-in package for mounting a variety of low-voltage electrical jacks or fiber optical connectors also referred to as keystone wall plates, face plates, surface-mount boxes or patch panel. Keystone modules have a rectangular face and are held in place with flexible tabs.

1.8 WARRANTIES:

- A Refer to Section 27 00 00 for general details.

1.9 MATERIALS:

- A All materials shall be UL or ETL listed and verified and shall be marked as such.
- B Products shall be regularly catalogued items of the manufacturer and shall be supplied as a complete unit in accordance with the manufacturer's standard specifications with any optional items required for proper installation unless otherwise noted.
 1. All materials used on this project shall be new. Used and refurbished equipment is not permitted. Provide equipment to site in original packaging whenever practical.

1.10 DELIVERY, STORAGE, AND HANDLING LOGISTICS:

- A Material shall be delivered to the site in the original packing.
- B Materials delivered to the construction site shall be stored in a dry, secure area, preferably indoors. Storage temperature of materials shall adhere to manufacturer's recommendations. Movement of packaged materials shall be in a manner to avoid damage of contents. On-site storage, either indoors or trailer, shall have permission by the School District of Osceola County Staff, and shall not interfere with other construction activity.
- C Installation of Category 5e, Category 6, or Category 6a cable shall be within the recommended temperature range specified by the manufacturer. Cable installation temperature range between 50°F and 80°F is recommended. Cabling should only be installed in facilities that are not exposed to the elements.
- D The Contractor is responsible for scheduling all deliveries and providing proper receipt, handling, and storage of all materials. Protect all equipment from physical damages (dents, scratches, dust, water, paint, chemicals, and temperature extremes) and vandalism, or theft. The Contractor shall replace any damaged or stolen equipment. The Contractor is responsible for all equipment until final project acceptance by the School District of Osceola County.
- E The Contractor is responsible for cleaning the worksite every business day and removing debris from the facility.

1.11 COORDINATION WITH OTHER TRADES:

- A Coordinate layout of work with other trades. Make minor adjustments in locations required for coordination. Locations of structural systems, heating work and plumbing lines shall take preference over locations of conduit lines where conflict occurs. Structural systems, heating work, and plumbing lines shall not interfere with or otherwise impede the routing of communication cabling with cable tray, raceways, or other pathways dedicated to communications. All potential issues shall be brought to the attention of the General Contractor, Construction Manager, Architect, Engineer, Project Technology Designer (RCDD), and SDOC Technology Services Department Representative immediately, before proceeding with installation.
- B Other than minor issues, adjustments shall be submitted to the General Contractor, Construction Manager, Architect, Engineer, Project Technology Designer (RCDD), and SDOC Technology Services Department Representative for approval before proceeding with the work.
- C Coordinate locations, arrangement, mounting, and support of all communications provisions with Division 26 Representative, Project Technology Designer (RCDD), and SDOC Technology Services Department Representative that:
 1. Allow maximum possible headroom unless specific mounting heights that reduce headroom are indicated.
 2. Provide for ease of disconnecting the equipment with minimum interference to other installations.

3. Allow right of way for piping and conduit installed at required slope.
4. Coordinate that connecting raceways, cables, and cable trays will be clear of obstructions and of the working and access space of other equipment.
5. Coordinate installation of required supporting devices and set sleeves in cast-in-place concrete, masonry walls, and other structural components as they are constructed.
6. Coordinate sleeve selection specified in Division 07 and Division 26.
7. Coordinate location of access panels and doors for electrical items that are behind finished surfaces or otherwise concealed.
8. Coordinate the gauge cables to be used in the telecommunications grounding system.

PART 2 PRODUCTS:

2.1 WALL FACEPLATE – REAR LOADING:

- A Faceplates for single gang outlets shall have from 1 to 6 ports.
- B Provides a rear loading, snap in, flush mounting of keystone connectors.
- C Single gang.
- D All parts are to be same color to match electrical installation (stainless, off white, white, etc.).
- E All IFP plates are supplied with paper labels, clear screw covers, and color-matched screw covers.
- F UL listed and cUL certified.
- G ANSI/TIA-606-B station labeling capability.
- H UL 94V-0 rated flame-retardant material.
- I Mounts to standard NEMA openings and boxes.

2.2 WALL FACEPLATE – FRONT LOADING:

- A The IMF modular plates provide the flexibility to tailor each workstation solution to your specific requirements. The front-loading plates accept modules in 3 Unit combinations for single gang.
- B Aesthetic, rounded profile single gang face plate.
- C All parts are to be the same color match as electrical installation (stainless, off white, white, etc..).
- D All IFP plates are supplied with paper labels, clear screw covers, and color-matched screw covers.
- E UL listed and cUL certified.
- F Field configurable, front loading, easy snap in keystone mounting modules.
- G Supports copper, fiber, and AV applications.
- H ANSI/TIA-606-B station labeling capability.
- I UL 94V-0 rated flame-retardant material.
- J Mounts to standard NEMA openings and boxes.

2.3 WALL PHONE FACEPLATE W/ JACK:

- A Faceplates shall be stainless steel with two studs for hanging a wall phone.
- B Studs mounted in standard positions to accommodate any standard wall phone.
- C Mounts to any single gang wall box, universally accepted.
- D Accepts 2 phone styles: flush or semi-extended jack mount.
- E Keystone opening accepts HPW HD series jacks.
- F Fast and easy to install – cost effective.
- G Accepts Category 6 Modular Jack.

2.4 SURFACE MOUNT BOXES:

- A Uses HPW Keystone adapters and jacks. (AV, Fiber and Copper).
- B UL and cUL Listed 1863.
- C ANSI/TIA/EIA-606-B compliant.
- D ADA compliant.
- E RoHS Compliant.
- F Material High-impact thermoplastic (UL 94V-0).
- G Plenum and workstation rated.
- H Box must have an option for attachment with screws.
- I All parts are to be white in color unless otherwise noted.

2.5 MODULAR JACKS:

- A Category 6 jack:
 1. Jacks shall be standard 8-position, RJ-45 style, un-keyed, FCC compliant.
 2. Each jack shall be single unit construction, with snap – fit to industry standard keystone opening (.760" x .580").
 3. Jack housings shall be high impact UL 94 v-0 rated thermoplastic.
 4. Jacks shall have a temperature rating of -10°C (14°F) to 70°C (158°F).
 5. Jack housings shall fully encase and protect printed circuit boards and IDC fields.
 6. Housings shall be ultrasonically welded for tamper resistance.
 7. Modular jack contacts shall accept a minimum of 2000 mating cycles without degradation of electrical or mechanical performance.
 8. Jack contacts shall maintain a minimum deflection force of 100 grams while mated with an FCC- standard RJ-45 plug.
 9. Jack contacts shall be formed flat for increased surface contact with mated plugs.
 10. Jack contacts shall be constructed of beryllium copper for maximum spring force and durability. Contact plating shall be a minimum of 50 micro-inches of hard gold in the contact area over 50 micro-inches of nickel.
 11. Jack termination method shall follow the industry standard 110 IDC punch-down. Jacks shall be compatible with single conductor standard 110 impact termination tools.
 12. Jacks shall be compatible with a 4-pair single punch impact tool designed specifically for the purpose
 13. Jacks shall have their category rating designation, visible from the front when installed.
 14. Bottom of jack shall have date code and an abbreviated catalog number.
 15. Jacks shall terminate 26-22 awg solid conductors.
 16. Jacks shall not require special cords, specialty tools or special installation requirements.
 17. Stuffer cap shall have retention snaps to assure conductor strain relief.
 18. Jacks shall accept optional hinged dust covers
 19. Jacks shall be compatible with ANSI/TIA-606-B color code labeling.
 20. Jacks shall accept snap-on icons for specific identification.
 21. Jacks shall be available in various colors to meet specific customer applications.
 22. Jacks shall have attached wiring instruction labels to permit T568a wiring configurations.
 23. Category rated jacks shall be backward compatible for fit, form, and function.
 24. Jacks shall be **manufactured in the USA.**

25. All transmission performance parameters shall be independently verified by a UL or ETL third party testing organization.
 26. Jacks shall be UL listed 1863 and CSA certified.
 27. Jacks shall exceed IEEE 802.3af DTE power specification to 4 times the rated current limits with no degradation of performance or materials.
 28. Jacks shall exceed IEEE802.3bt DTE power specification.
 29. Jacks shall be third party verified, to meet or exceed performance requirements.
 30. Component rated per ANSI/TIA-568.2-D.
 31. Colors specified by end user.
- B Category 6a jack:
1. Jacks shall be standard 8-position, RJ-45 style, un-keyed, FCC compliant.
 2. Each jack shall be single unit construction, with snap – fit to industry standard keystone opening (.760” x .580”).
 3. Jack housings shall be high impact UL 94 v-0 rated thermoplastic.
 4. Jacks shall have a temperature rating of -10^oc (14^of) to 70^oc (158^of).
 5. Jack housings shall fully encase and protect printed circuit boards and IDC fields.
 6. Housings shall be ultrasonically welded for tamper resistance.
 7. Modular jack contacts shall accept a minimum of 2000 mating cycles without degradation of electrical or mechanical performance.
 8. Jack contacts shall maintain a minimum deflection force of 100 grams while mated with an FCC- standard RJ-45 plug.
 9. Jack contacts shall be formed flat for increased surface contact with mated plugs.
 10. Jack contacts shall be constructed of beryllium copper for maximum spring force and durability. Contact plating shall be a minimum of 50 micro-inches of hard gold in the contact area over 50 micro-inches of nickel.
 11. Jack termination method shall follow the industry standard 110 IDC punch-down. Jacks shall be compatible with single conductor standard 110 impact termination tools.
 12. Jacks shall be compatible with a 4-pair single punch impact tool designed specifically for the purpose.
 13. Jacks shall have their category rating designation, visible from the front when installed.
 14. Bottom of jack shall have date code and an abbreviated catalog number.
 15. Jacks shall terminate 26-22 awg solid conductors.
 16. Jacks shall not require special cords, specialty tools or special installation requirements.
 17. Stuffer cap shall have retention snaps to assure conductor strain relief.
 18. Jacks shall accept optional hinged dust covers
 19. Jacks shall be compatible with ANSI/TIA-606-B color code labeling.
 20. Jacks shall accept snap-on icons for specific identification.
 21. Jacks shall be available in various colors to meet specific customer applications.
 22. Jacks shall have attached wiring instruction labels to permit T568a wiring configurations.
 23. Category rated jacks shall be backward compatible for fit, form, and function.
 24. Jacks shall be **manufactured in the USA**.
 25. All transmission performance parameters shall be independently verified by a UL or ETL third party testing organization.
 26. Jacks shall be UL listed 1863 and CSA certified.

27. Jacks shall exceed IEEE 802.3af DTE power specification to 4 times the rated current limits with no degradation of performance or materials.
28. Jacks shall exceed IEEE802.3bt DTE power specification.
29. Jacks shall be third party verified, to meet or exceed performance requirements.
30. Component rated per ANSI/TIA-568.2-D.
31. Colors specified by end user.

PART 3 EXECUTION:

3.1 GENERAL:

- A Quantities of system elements shown on the drawings are illustrative only and are meant to indicate the general configuration of the work. The Contractor is responsible for providing the correct quantities of materials to construct a system that meets the intent of these Specifications and the relevant codes.
- B Follow all manufacturers' instructions.
- C Faceplates and modular jack installation shall be in conformance to ANSI/TIA-568.0-D & ANSI/TIA-568.1- D standards, BICSI methods, industry standards and manufacturer's guidelines.
- D Coordinate with all other trades prior to pre-construction submittals and installation.

3.2 LABELING:

- A All labels shall be permanent, machine generated labels produced by a labeling machine. Labels shall be a permanent polyester material clear in color with label lettering black in color. No handwritten labels will be accepted.
- B Labeling information will be reviewed at pre-installation meeting, and the Project Technology Designer (Project Electrical Engineer and Registered Communications Distribution Designer (RCDD)) and SDOC Technology Services Department Representative shall approve the labeling scheme prior to the installation of any cabling.
- C Surfaces shall be cleaned before attaching labels. All labels shall be attached firmly and vertically plumb on equipment, faceplates, patch panel termination blocks, etc.
- D All labeling of cables, equipment, and components shall be included in as-built documentation, floor plan drawings, and schematic designs.

3.3 FACEPLATE:

- A Faceplates shall be installed straight and plumb in all directions.
- B Wall faceplates shall be installed at the same height as accompanying electrical outlets unless specific heights are noted.
- C Faceplates shall be installed at appropriate ADA height.
- D Faceplates shall be installed with screws.
- E Should the faceplate not cover the entirety of the outlet box hole in the wall due to overcutting or rough workmanship, the wall shall be appropriately patched and painted for a neat and clean finished appearance.
- F All telecommunications outlets, with the exception of surface mount boxes, are only to be installed over enclosed back boxes.
- G All faceplates shall be fastened to back box with threaded machine screws of appropriate length. Fill all module unused openings with blank modules.

3.4 WALL PHONE FACEPLATE:

- A Refer to the ADA for requirements concerning wall mount telecommunications devices.

3.5 SURFACE MOUNT BOXES:

- A Surface mount boxes are only to be used in new construction for outlets above the ceiling or in mechanical / electrical spaces.
- B Surface mount boxes are not to be used in communication CD (MDF) / FD (IDF) locations, user spaces, or any other new construction areas (interior or exterior).

- C Surface mount boxes must be permanently attached to the building's structure with screws.
- D Surface mount boxes must not be installed inside panels used for other services unless those panels are accessible by a certified Contractor.

3.6 MODULAR JACK (INCLUDING SURFACE-MOUNT):

- A Follow all Manufacturer instructions.
- B All category modular jacks shall be terminated using the T568a termination scheme specified in ANSI/TIA-568.0-D.
- C Modular jacks terminated in areas prior to final cleaning (e.g., painting, carpet installation, dusty areas) shall be placed in a protective envelope to ensure dust, debris, moisture and other foreign materials do not settle onto modular jack contacts. Once final cleaning is complete, modular jacks shall be inserted into faceplates and screwed into place.
- D Pair-twist shall be maintained up to the point of termination.
- E Cable sheath shall be maintained up to within 0.5 inches of the modular jack termination.

END OF SECTION 27 15 43

[REMAINDER OF PAGE INTENTIONALLY LEFT BLANK]

COMMUNICATIONS PATCH CORDS AND CABLING

PART 1 GENERAL:

1.1 INTRODUCTION:

A COMMUNICATION PATCHING CABLING:

1. The work covered by this section of the Specifications includes all labor necessary to perform and complete such construction, all materials and equipment incorporated or to be incorporated in such construction and all services, facilities, tools and equipment necessary or used to perform and complete such construction. The work of this section shall include, but is not limited to, the following:

B. Technology patch cords, station cords, fiber optic patch cords, and cross-connect cabling and accessories in accordance with the strictest manufacturer written recommendation per code or the best industry practice. These communication specifications are requirements for all School District of Osceola County (SDOC) projects. Request for deviations from these guides and requirements must be made in writing to the School Board of Osceola County.

1.2 RELATED DOCUMENTS:

A Division 27 Sections that apply to this Section are:

1. Section 27 00 00 Communications
2. Section 27 05 26 Grounding & Bonding for Communications Systems
3. Section 27 05 28 Pathways for Communications Systems
4. Section 27 05 36 Cable Trays for Communications Systems
5. Section 27 11 10 Telecommunications Spaces, Equipment and Fittings
6. Section 27 13 13 Communications Copper Backbone Cabling
7. Section 27 13 23 Communications Optical Fiber Backbone Cabling
8. Section 27 15 13 Communications Copper Horizontal Cabling
9. Section 27 15 43 Communications Faceplates and Modules
10. Section 27 21 33 Wireless Access Point System
11. Section 27 41 16 Classroom Amplification System
12. Section 27 51 23 Educational Intercom and Program Clock System
13. Section 27 53 21 Distributed Antenna System – Public Safety

1.3 STANDARDS AND CODES:

- A Refer to other sections in Division 27 00 00 – Communications
- B Refer to Division 01 – Reference Standards and General Conditions of the Contract
- C Complies with both ANSI/TIA-607-C and NEC Article 250. The most stringent rules apply.

1.4 APPROVED PRODUCT MANUFACTURERS:

A The manufacturer of patch cords, stations cords, fiber optic patch cords, and cross-connect cabling, that School District of Osceola County is using as basis of design in this document, as required for construction of the cabling infrastructure per contract documents shall be:

1. Hubbell Premise Wiring

- B. Product substitutions from other manufacturers shall require the approval of the Project Technology Designer (Project Electrical Engineer and Registered Communication Distribution Designer (RCDD)) and SDOC Technology Services Department Representative 10 business days prior to bid opening.

1.5 SUBMITTALS:

- A. Shop Drawings:
 - 1. Shop drawings will indicate the location of cable routes, bundle sizes, and penetrations (including cable trays, mechanical firestops, and interior / exterior sleeving), and will require the approval of the Project Technology Designer (Project Electrical Engineer and Registered Communication Distribution Designer (RCDD)) and SDOC Technology Services Department Representative prior to implementation.
- B. Submit Manufacturer's Cut Sheets for the following (Refer to Section 27 00 00 – Communications Submittal):
 - 1. Major items not included in the Product Section.
 - 2. Submit for approval in accordance with specified submittal procedures:
 - a) Patch Cords
 - b) Station Cords
 - c) Fiber Optic Patch Cords
 - d) Cross-connect cabling

1.6 QUALITY ASSURANCE:

- A. Manufacturer:
- B. Firms regularly engaged in manufacture of the materials, called out for in this section, whose products have been in satisfactory use in similar service for not less than 3 years.
- C. The Contractor will install work in accordance with the latest School District of Osceola County Requirements, the latest BICSI Information Technology Systems Installation Methods Manual, Telecommunications Distribution Methods Manual, TIA/EIA Standard Commercial Building Telecommunications Cabling Standard, systems planning and design manual.
- D. The Contractor who is installing the materials and installing the system will be trained by the referenced manufacturer in the proper installation practices. The Contractor will have the proper tools and test equipment to insure a good and proper installation.
- E. Installed UTP and fiber cabling systems, pathways and distribution facilities will adhere to manufacturer's instructions, contract drawings and specifications, and applicable codes, standards and regulations
- F. Installed UTP cabling systems and field test results will strictly adhere to requirements of ANSI/TIA-568-0.D, ANSI/TIA-568-1.D and ANSI/TIA/EIA-568-2.D.
- G. Installed optical fiber cabling systems and field test results will strictly adhere to requirements of ANSI/TIA-568-0.D and ANSI/TIA/EIA-568-3.D.
- H. Where applicable, all equipment, components, accessories and hardware will be UL listed for the intended purpose of the installation.
- I. All critical internal manufacturing operations for installed products will have documented in-process inspection and testing according to ISO9001.
- J. Installed products will be manufactured by an ISO9001 certified facility.
- K. Installed products will be free from defects in material or workmanship from the manufacturer and will be of the quality indicated.
- L. All methods of construction that are not specified in the contract documents will be subject to control and approval by the Project Technology Designer (RCDD) and SDOC Technology Services Department Representative.
- M. Installed products will be lot-traceable by date code.

1.7 DEFINITION:

A Patch Cord:

1. A Patch cable, patch cord or patch lead is an electrical or optical cable used to connect one electronic or optical device to another for signal routing. Devices of different types (e.g., a switch connect to a computer, or a switch to a router) are connected with patch cords.

B Cross-connect Cable:

1. A cross-connect is a physical, hardwired cable that provides a direct connection between two different termination locations within a data center – includes Fiber Optic, Coaxial, and Copper.

1.8 WARRANTIES:

- A Refer to Section 27 00 00 for general details.

1.9 MATERIALS:

- A All materials shall be UL or ETL listed and verified and shall be marked as such.

- B Products shall be regularly catalogued items of the manufacturer and shall be supplied as a complete unit in accordance with the manufacturer's standard specifications with any optional items required for proper installation unless otherwise noted.

1. All materials used on this project shall be new. Used and refurbished equipment are not permitted. Provided equipment on site in original packaging whenever practical.

1.10 DELIVERY, STORAGE AND HANDLING LOGISTICS:

- A Material shall be delivered to the site in the original packing.

- B Materials delivered to the construction site shall be stored in a dry, secure area, preferably indoors. Storage temperature of materials shall adhere to manufacturer's recommendations. Movement of packaged materials shall be in a manner to avoid damage of contents. On-site storage, either indoors or trailer, shall have permission by the School District of Osceola County Staff, and shall not interfere with other construction activity.

- C Installation of Category 5e, Category 6 or Category 6a cable shall be within the recommended temperature range specified by the manufacturer. Cable installation temperature range between 500f and 800f is recommended. Cabling should only be installed in facilities that are not exposed to the elements.

- D The Contractor is responsible for scheduling all deliveries and providing proper receipt, handling, and storage of all materials. Protect all equipment from physical damages (dents, scratches, dust, water, paint, chemicals, and temperature extremes) and vandalism, or theft. The Contractor shall replace any damaged or stolen equipment. The Contractor is responsible for all equipment until final project acceptance by the School District of Osceola County.

- E The Contractor is responsible for cleaning the worksite every business day and removing debris from the facility.

1.11 COORDINATION WITH OTHER TRADES:

- A Coordinate layout of work with other trades. Make minor adjustments in locations required for coordination. Locations of structural systems, heating work and plumbing lines shall take preference over locations of conduit lines where conflict occurs. Structural systems, heating work, and plumbing lines shall not interfere with or otherwise impede the routing of communication cabling with cable tray, raceways, or other pathways dedicated to communications. All potential issues shall be brought to the attention of the General Contractor, Construction Manager, Architect, Engineer, Project Technology Designer (RCDD), and SDOC Technology Services Department Representative immediately, before proceeding with installation.

- B Other than minor issues, adjustments shall be submitted to the General Contractor, Construction Manager, Architect, Engineer, Project Technology Designer (RCDD), and SDOC Technology Services Department Representative for approval before proceeding with the work.

- C. Coordinate locations, arrangement, mounting, and support of all communications provisions with Division 26 Representative, Project Technology Designer (RCDD), and SDOC Technology Services Department Representative that:
 - 1. Allow maximum possible headroom unless specific mounting heights that reduce headroom are indicated.
 - 2. Provide for ease of disconnecting the equipment with minimum interference to other installations.
 - 3. Allow right of way for piping and conduit installed at required slope.
 - 4. Coordinate that connecting raceways, cables, and cable trays will be clear of obstructions and of the working and access space of other equipment.
 - 5. Coordinate installation of required supporting devices and set sleeves in cast-in-place concrete, masonry walls, and other structural components as they are constructed.
 - 6. Coordinate sleeve selection specified in Division 07 and Division 26.
 - 7. Coordinate location of access panels and doors for electrical items that are behind finished surfaces or otherwise concealed.
 - 8. Coordinate the gauge cables to be used in the telecommunications grounding system.

PART 2 PRODUCTS:

2.1 STANDARD COPPER CABLE COLORS:

- A. Patch Cords (Telecom Room) Server – Purple
- B. Patch Cords (Telecom Room) Data – Yellow
- C. Patch Cords – Intercom / Clocks / AV – Green
- D. Patch Cords – Wireless Access Point – Pink
- E. Patch Cords – Telephone – Black
- F. Patch Cords – HVAC / Environmental – White
- G. Patch Cords – Security / Camera – Orange
- H. Station Cords (User End) – Yellow
- I. Patch Cords – Fire Alarm – Red
- J. Patch Cords – UPS – Blue
- K. Cross-connect – Red (where applicable)

2.2 STANDARD COPPER PATCH CABLES:

- A. Category 6 Patch Cords (Station patch cords):
 - 1. Provide 8-position/8-conductor modular RJ45 type plugs compatible with industry standard modular jacks.
 - 2. Extended strain relief for added protection in high density applications.
 - 3. The cord shall be of stranded construction and shall be available in one (1) and four (4) pair configurations.
 - 4. Snag-less, Booted Design - Easy to route and cable manage without the latch getting caught.
 - 5. Flexible cable for easy cable management.
 - 6. Backwards compatible to Cat 5e, 5 & 3.
 - 7. Cable Construction:
 - a) Conductor: 24AWG UTP

- b) OD: 0.224"
 - c) Jacket: Flame-Retardant PVC – CM Rated
 - 8. Plug Material:
 - a) Plug body: Polycarbonate UL 94V-0
 - b) Plug boot: Polycarbonate UL 94V-0
 - 9. Contact:
 - a) High strength copper alloy
 - 10. Plating: 50 micro-inch Gold with 100 micro-inch underplating
 - 11. Mechanical:
 - a) Cable to plug tensile strength: 20+ lbs.
 - b) Mating cycles: 2000+
 - 12. TIA-568.2-D Category 6 component
 - 13. Channel: Third-Party tested for TIA 568.2-D
 - 14. Category 6 and ISO 11801 Class E
 - 15. IEEE 802.3af, IEEE 802.3at & IEEE 802.3bt compliant
 - 16. UL Listed 1863
- B. Category 6A Patch Cords (Station patch cords):
1. Provide 8-position/8-conductor modular RJ45 type plugs compatible with industry standard modular jacks.
 2. Extended strain relief for added protection in high density applications.
 3. The cord shall be of stranded construction and shall be available in one (1) and four (4) pair configurations.
 4. Snag-less, Booted Design - Easy to route and cable manage without the latch getting caught.
 5. Soft flexible cable for easy cable management.
 6. Backwards compatible to Cat 6, 5e, 5 & 3.
 7. Cable Construction:
 - a) Conductor: 26AWG UTP
 - b) Jacket: Dual Layer Flame-Retardant PVC – CM Rated
 8. Plug Material:
 - a) Plug body: Polycarbonate UL 94V-0
 - b) Plug boot: Polycarbonate UL 94V-0
 9. Contact: High strength copper alloy.
 10. Plating: 50 micro-inch Gold with 100 micro-inch underplating.
 11. Mechanical:
 - a) Cable to plug tensile strength: 20+ lbs.
 - b) Mating cycles: 2000+
 12. ANSI/TIA-568.2-D Category 6A component.

13. ISO 11801/60603-7-41 Category 6A component.
14. Mechanical: Verified to TIA-568.2-D.
15. UL Listed 1863.
16. TIA-568-C.2 Category 6A component.
17. Channel: Third-Party tested for TIA 568-C.2.
18. Category 6A and ISO 11801 Class EA.
19. Application: Third-Party qualified for 10 Gigabit Ethernet Transmission IEEE 802.3an.
20. Current Capacity: Exceeds current levels for PoE and PoE+ IEEE802.3at.
21. Tested to 150% of IEEE 802.3bt.

2.3 LOW DIAMETER COPPER PATCH CABLES:

A Category 6 (Equipment patch cords ONLY):

1. O.D. = 0.155"
2. 28 AWG stranded conductors.

B Category 6A (Equipment patch cords ONLY):

1. O.D. = 0.186"
2. 28 AWG stranded conductors.

2.4 FIBER OPTIC PATCH CORDS:

A Multimode:

1. 50/125mm Laser Optimized, OM3.
2. Duplex LC to LC.
3. High quality zirconia ferrules for high performance and superior durability.
4. Low mated pair insertion loss - minimum impact on signal budget:
 - a) <0.35 dB
5. Diameter over Jacket shall be 3mm max.
6. Wide temperature operating range for environmental stability.
7. Multi-Mode Fiber Optic Patch Cables (Aqua Jacket)

B Single Mode:

1. 8.3/125mm, OS2.
2. Duplex LC to LC.
3. High quality zirconia ferrules for high performance and superior durability.
4. Low mated pair insertion loss - minimum impact on signal budget:
 - a) <0.35 dB
5. Diameter over Jacket shall be 3mm max.
6. Wide temperature operating range for environmental stability.
7. Single Mode Fiber Optic Patch Cables (Yellow Jacket)

2.5 HDMI CABLE:

- A Standard HDMI:
 - 1. Cable Construction:
 - a) Conductor: 24 AWG
 - b) OD: 0.375
 - c) Jacket: Flame-Retardant PVC
 - 2. Contact:
 - a) Braided Copper
 - 3. Shield:
 - a) Aluminum Foil
 - 4. Insulation:
 - a) 30% Glass Filled LCP
- B High Speed 4K HDMI cable:
 - 1. Supports 4K@60Hz
 - 2. Supports 18 Gbps bandwidth

PART 3 EXECUTION:

3.1 GENERAL:

- A All Manufacturer's care and installation instructions shall be followed.
- B Copper station or patch cords, no single cord shall exceed 15 feet in length.
- C All copper cables will be fit with less than 10% slack on the equipment rack.
- D All patch cords shall be factory manufactured. NO on-site patch cords shall be created or deployed – **NO EXCEPTIONS**

END OF SECTION 27 16 19

[REMAINDER OF PAGE INTENTIONALLY LEFT BLANK]

WIRELESS ACCESS POINT SYSTEMS

PART 1 GENERAL:

1.1 INTRODUCTION :

A. Wireless Access Point:

1. The work covered by this section of the Specifications includes all labor necessary to perform and complete such construction, all materials and equipment incorporated or to be incorporated in such construction and all services, facilities, tools and equipment necessary or used to perform and complete such construction. The work of this section shall include, but is not limited to, the following:
 - a) Technology wireless access point (WAP) installations, cabling and accessories in accordance with the strictest manufacturer written recommendation per code or the best industry practice. These communication specifications are requirements for all School District of Osceola County (SDOC) projects. Request for deviations from these guides and requirements must be made in writing to the School Board of Osceola County.

1.2 RELATED DOCUMENTS:

A. Division 27 Sections that apply to this Section are:

1. Section 27 00 00 Communications
2. Section 27 05 26 Grounding & Bonding for Communications Systems
3. Section 27 05 28 Pathways for Communications Systems
4. Section 27 05 36 Cable Trays for Communications Systems
5. Section 27 11 10 Telecommunications Spaces, Equipment and Fittings
6. Section 27 13 13 Communications Copper Backbone Cabling
7. Section 27 13 23 Communications Optical Fiber Backbone Cabling
8. Section 27 15 13 Communications Copper Horizontal Cabling
9. Section 27 15 43 Communications Faceplates and Modules
10. Section 27 16 19 Communications Patch Cords and Station Cords
11. Section 27 41 16 Classroom Amplification System
12. Section 27 51 23 Educational Intercom and Program Clock System
13. Section 27 53 21 Distributed Antenna System – Public Safety

1.3 STANDARDS AND CODES:

- A. Refer to other sections in Division 27 00 00 – Communications
- B. Refer to Division 01 – Reference Standards and General Conditions of the Contract
- C. Complies with both ANSI/TIA-607-C and NEC Article 250. The most stringent rules apply.

1.4 APPROVED PRODUCT MANUFACTURERS:

- A. The manufacturer of hardware, devices, and components, that School District of Osceola County is using as basis of design in this document, as required for construction of the cabling infrastructure per contract documents shall be:
 1. Hubbell Premise Wiring
- B. Product substitutions from other manufacturers shall require the approval of the Project Technology Designer (Project Electrical Engineer and Registered Communication Distribution Designer (RCDD)) and SDOC Technology Services Department Representative 10 business days prior to bid opening.

1.5 SUBMITTALS:

A. Shop Drawings:

1. Shop drawings will indicate the location of cable routes, bundle sizes, and penetrations (including cable

trays, mechanical firestops, and interior / exterior sleeving), and will require the approval of the Project Technology Designer (Project Electrical Engineer and Registered Communication Distribution Designer (RCDD)) and SDOC Technology Services Department Representative prior to implementation.

- B. Submit Manufacturer's Cut Sheets for the following (Refer to Section 27 00 00 – Communications Submittal):
 - 1 Major items not included in the Product Section.
 - 2 Submit for approval in accordance with specified submittal procedures:
 - a) Cable
 - b) Modular Jacks
 - c) Face Plates
 - d) Patch panels
 - e) Brackets
 - f) Supports / trays / hardware

1.6 QUALITY ASSURANCE:

- A. Manufacturer:
 - 1 Firms regularly engaged in manufacture of the materials, called out for in this section, whose products have been in satisfactory use in similar service for not less than 3 years.
- B. The Contractor will install work in accordance with the latest School District of Osceola County Requirements, the latest BICSI Information Technology Systems Installation Methods Manual, Telecommunications Distribution Methods Manual, TIA/EIA Standard Commercial Building Telecommunications Cabling Standard, systems planning and design manual.
- C. The Contractor who is installing the materials and installing the system will be trained by the referenced manufacturer or SDOC Networking Representative in the proper installation practices. The Contractor will have the proper tools and test equipment to insure a good and proper installation.
- D. Installed UTP cabling systems, pathways and distribution facilities will adhere to manufacturer's instructions, contract drawings and specifications, and applicable codes, standards and regulations.
- E. Installed UTP cabling systems and field test results will strictly adhere to requirements of ANSI/TIA-568-0.D, ANSI/TIA-568-1.D and ANSI/TIA/EIA-568-2.D.
- F. Where applicable, all equipment, components, accessories and hardware will be UL listed for the intended purpose of the installation.
- G. All critical internal manufacturing operations for installed products will have documented in-process inspection and testing according to ISO9001.
- H. Installed products will be manufactured by an ISO9001 certified facility.
- I. Installed products will be free from defects in material or workmanship from the manufacturer and will be of the quality indicated.
- J. All methods of construction that are not specified in the contract documents will be subject to control and approval by the Project Technology Designer (RCDD) and SDOC Technology Services Department Representative.
- K. Installed products will be lot-traceable by date code.

1.7 DEFINITION:

- A. Wireless Access Point:
 - 1 A networking hardware device that allows Wi-Fi devices (laptops, tablets, etc.) to connect to a wired network. Also referred to as an Access Point.

1.8 WARRANTIES:

- A. Refer to Section 27 00 00 for general details.

1.9 MATERIALS:

- A. All materials shall be UL or ETL listed and verified and shall be marked as such.
- B. Products shall be regularly catalogued items of the manufacturer and shall be supplied as a complete unit in

accordance with the manufacturer's standard specifications with any optional items required for proper installation unless otherwise noted.

1. All materials used on this project shall be new. Used and refurbished equipment are not permitted. Provided equipment on site in original packaging whenever practical.

1.10 DELIVERY, STORAGE AND HANDLING LOGISTICS:

- A. Material shall be delivered to the site in the original packing.
- B. Materials delivered to the construction site shall be stored in a dry, secure area, preferably indoors. Storage temperature of materials shall adhere to manufacturer's recommendations. Movement of packaged materials shall be in a manner to avoid damage of contents. On-site storage, either indoors or trailer, shall have permission by the School District of Osceola County Staff, and shall not interfere with other construction activity.
- C. Installation of Category 6a cable shall be within the recommended temperature range specified by the manufacturer. Cable installation temperature range between 50°f and 80°f is recommended. Cabling should only be installed in facilities that are not exposed to the elements.
- D. The Contractor is responsible for scheduling all deliveries and providing proper receipt, handling, and storage of all materials. Protect all equipment from physical damages (dents, scratches, dust, water, **paint**, chemicals, and temperature extremes) and vandalism, or theft. The Contractor shall replace any damaged or stolen equipment. The Contractor is responsible for all equipment until final project acceptance by the School District of Osceola County.
- E. The Contractor is responsible for cleaning the worksite every business day and removing debris from the facility.

1.11 COORDINATION WITH OTHER TRADES:

- A. Coordinate layout of work with other trades. Make minor adjustments in locations required for coordination. Locations of structural systems, heating work and plumbing lines shall take preference over locations of conduit lines where conflict occurs. Structural systems, heating work, and plumbing lines shall not interfere with or otherwise impede the routing of communication cabling with cable tray, raceways, or other pathways dedicated to communications. All potential issues shall be brought to the attention of the General Contractor, Construction Manager, Architect, Engineer, Project Technology Designer (RCDD), and SDOC Technology Services Department Representative immediately, before proceeding with installation.
- B. Other than minor issues, adjustments shall be submitted to the General Contractor, Construction Manager, Architect, Engineer, Project Technology Designer (RCDD), and SDOC Technology Services Department Representative for approval before proceeding with the work.
- C. Coordinate locations, arrangement, mounting, and support of all communications provisions with Division 26 Representative, Project Technology Designer (RCDD), and SDOC Technology Services Department Representative that:
 1. Allow maximum possible headroom unless specific mounting heights that reduce headroom are indicated.
 2. Provide for ease of disconnecting the equipment with minimum interference to other installations.
 3. Allow right of way for piping and conduit installed at required slope.
 4. Coordinate that connecting raceways, cables, and cable trays will be clear of obstructions and of the working and access space of other equipment.
 5. Coordinate installation of required supporting devices and set sleeves in cast-in-place concrete, masonry walls, and other structural components as they are constructed.
 6. Coordinate sleeve selection specified in Division 07 and Division 26.
 7. Coordinate location of access panels and doors for electrical items that are behind finished surfaces or otherwise concealed.
 8. Coordinate the gauge cables to be used in the telecommunications grounding system.
- D. Low Voltage Contractor shall furnish and install the following:
 1. Patch Panels
 2. Cable, Copper
 3. Modular Jacks

4. Face Plates
 5. Brackets
 6. Pathways
 7. Support / Trays / Racks
- E. Electrical Contractor shall furnish and install the following:
1. Conduit
 2. Outlet Boxes
 3. Penetrations
 4. Mechanical Firestop devices
 5. Sleeving (rated / non-rated barriers)
- F. Unless noted otherwise, the following items will be the responsibility of the School District of Osceola County Staff to provide or install (at the discretion of the Networking Department Representative or designate):
1. All electronics and active data networking equipment, etc.
 2. Wireless Access Points

PART 2 PRODUCTS:

2.1 CABLES:

- A. Category 6A:
1. Conductor: 23 awg solid barecopper
 2. 10GbE Application Assurance
 3. Maximum bandwidth beyond 750MHz
 4. Component Compliant ANEXT Performance
 5. PoE, PoE+ and 4PPoE – 100 Watt

2.2 PATCH PANEL:

- B. UTP Patch Panels, Category 6A:
1. 24 Port or 48 Port panels (unless otherwise noted).
 2. Panel shall be constructed of 16-gauge steel, rolled edge construction with black powder coat finish.
 3. Panel shall be standard 19-inch rack mount.
 4. Compatible with Hubbell XCELERATOR jacks: Category 6A Jacks, PINK in color.
 5. Panels comply with EIA-310-D rack mount standards.

2.3 JACKS:

- A. Category 6A:
1. Jacks shall be standard 8-position, RJ-45 style, un-keyed, FCC compliant
 2. Each jack shall be single unit construction, with snap – fit to industry standard keystone opening (.760” x .580”).
 3. Jack housings shall be high impact UL 94 v-0 rated thermoplastic.
 4. Jacks shall have a temperature rating of -10°C (14°F) to 70°C (158°F).
 5. Jack housings shall fully encase and protect printed circuit boards and IDC fields.
 6. Housings shall be ultrasonically welded for tamper resistance.
 7. Modular jack contacts shall accept a minimum of 2000 mating cycles without degradation of electrical or mechanical performance.
 8. Jack contacts shall maintain a minimum deflection force of 100 grams while mated with an FCC-standard RJ-45 plug.

9. Jack contacts shall be formed flat for increased surface contact with mated plugs.
10. Jack contacts shall be constructed of beryllium copper for maximum spring force and durability. Contact plating shall be a minimum of 50 micro-inches of hard gold in the contact area over 50 micro- inches of nickel.
11. Jack termination method shall follow the industry standard 110 IDC punch-down. Jacks shall be compatible with single conductor standard 110 impact termination tools.
12. Jacks shall be compatible with a 4-pair single punch impact tool designed specifically for the purpose.
13. Jacks shall have their category rating designation, visible from the front when installed.
14. Bottom of jack shall have date code and an abbreviated catalog number.
15. Jacks shall terminate 26-22 awg solid conductors.
16. Jacks shall not require special cords, specialty tools or special installation requirements.
17. Stuffer cap shall have retention snaps to assure conductor strain relief.
18. Jacks shall accept optional hinged dust covers.
19. Jacks shall be compatible with ANSI/TIA-606-B color code labeling.
20. Jacks shall accept snap-on icons for specific identification.
21. Jacks shall be available in various colors to meet specific customer applications.
22. Jacks shall have attached wiring instruction labels to permit T568a wiring configurations.
23. Category rated jacks shall be backward compatible for fit, form, and function.
24. Jacks shall be **manufactured in the USA**.
25. All transmission performance parameters shall be independently verified by a UL or ETL third party testing organization.
26. Jacks shall be UL listed 1863 and CSA certified.
27. Jacks shall exceed IEEE 802.3af DTE power specification to 4 times the rated current limits with no degradation of performance or materials.
28. Jacks shall exceed IEEE802.3bt DTE power specification.
29. Jacks shall be third party verified, to meet or exceed performance requirements.
30. Component rated per ANSI/TIA-568.2-D.
31. Colors to specified by end user.

2.4 SURFACE MOUNT BOXES:

- A. Uses HPW Keystone adapters and jacks. (AV, Fiber and Copper).
- B. UL and cUL Listed 1863.
- C. ANSI/TIA/EIA-606-B compliant.
- D. ADA compliant.
- E. RoHS Compliant.
- F. Material High-impact thermoplastic (UL94V-0).
- G. Plenum and workstation rated.
- H. Box must have an option for attachment with screws.
- I. All parts are to be off white in color unless otherwise noted.

PART 3 EXECUTION:

3.1 GENERAL:

- A. Quantities of system elements shown on the drawings are illustrative only and are meant to indicate the general configuration of the work. The Contractor is responsible for providing the correct quantities of materials to construct a system that meets the intent of these Specifications and the relevant codes.

- B. Follow all manufacturers' instructions.
- C. Faceplates and modular jack installation shall be in conformance to ANSI/TIA-568.0-D & ANSI/TIA-568.1- D standards, BICSI methods, industry standards and manufacturer's guidelines.
- D. Coordinate with all other trades prior to pre-construction submittals and installation.

3.2 LABELING:

- A. All labels shall be permanent, machine generated labels produced by a labeling machine. Labels shall be a permanent polyester material clear in color with label lettering black in color. No handwritten labels will be accepted. Black lettering with yellow background is permissible when applied to ceiling grid for ease of identification of Wireless Access Point locations.
- B. Labeling information will be reviewed at pre-installation meeting, and the Project Technology Designer (Project Electrical Engineer and Registered Communications Distribution Designer (RCDD)) and SDOC Technology Services Department Representative shall approve the labeling scheme prior to the installation of any cabling.
- C. Surfaces shall be cleaned before attaching labels. All labels shall be attached firmly and vertically plumb on equipment, faceplates, patch panels termination blocks, ceiling grid, etc.
- D. All labeling of cables, equipment, and components shall be included in as-built documentation, floor plan drawings, and schematic designs.

3.3 SURFACE MOUNT BOXES:

- A. Surface mount boxes are only to be used in new construction for outlets above the ceiling or in mechanical/electrical spaces.
- B. Surface mount boxes are not to be used in communication CD (MDF) / FD (IDF) locations, user spaces, or any other new construction areas.
- C. Surface mount boxes must be permanently attached to the building's structure with screws.
- D. Surface mount boxes must not be installed inside panels used for other services unless those panels are accessible by a certified Contractor.

3.4 MODULAR JACK (INCLUDING SURFACE-MOUNT):

- A. Follow all Manufacturer instructions.
- B. All category modular jacks shall be terminated using the T568a termination scheme specified in ANSI/TIA-568.0-D.
- C. Modular jacks terminated in areas prior to final cleaning (e.g., painting, carpet installation, dusty areas) shall be placed in a protective envelope to ensure dust, debris, moisture and other foreign materials do not settle onto modular jack contacts. Once final cleaning is complete, modular jacks shall be inserted into faceplates and screwed into place.
- D. Pair-twist shall be maintained up to the point of termination.
- E. Cable sheath shall be maintained up to within 0.5 inches of the modular jack termination.

3.5 INSTALLATION:

- A. All Manufacturer's care and installation instructions will be followed.
- B. Copper station or patch cords, no single cord shall exceed 15 feet in length.
- C. All copper cables will be fit with less than 10% slack on the equipment rack.
- D. All patch cables and modular jacks associated with Wireless Access Point installation shall be colored "PINK".
- E. All patch cords shall be factory manufactured. **NO** on-site patch cords shall be created or deployed – **NO EXCEPTIONS**

END OF SECTION 27 21 33

[REMAINDER OF PAGE INTENTIONALLY LEFT BLANK]

CLASSROOM AMPLIFICATION SYSTEM

PART 1 GENERAL:

1.1 INTRODUCTION :

A. Classroom Amplification System:

1. The work covered by this section of the Specifications includes all labor necessary to perform and complete such construction, all materials and equipment incorporated or to be incorporated in such construction and all services, facilities, tools and equipment necessary or used to perform and complete such construction. The work of this section shall include, but is not limited to, the following:
 - a) Classroom Amplification system, including speakers, microphones, amplifiers, associated hardware, and devices in accordance with the strictest manufacturer written recommendation per code or the best industry practice. These communication specifications are requirements for all School District of Osceola County (SDOC) projects. Request for deviations from these guides and requirements must be made in writing to the School Board of Osceola County.

1.2 RELATED DOCUMENTS:

A. Division 27 Sections that apply to this Section are:

1. Section 27 00 00 Communications
2. Section 27 05 26 Grounding & Bonding for Communications Systems
3. Section 27 05 28 Pathways for Communications Systems
4. Section 27 05 36 Cable Trays for Communications Systems
5. Section 27 11 10 Telecommunications Spaces, Equipment and Fittings
6. Section 27 13 13 Communications Copper Backbone Cabling
7. Section 27 13 23 Communications Optical Fiber Backbone Cabling
8. Section 27 15 13 Communications Copper Horizontal Cabling
9. Section 27 15 43 Communications Faceplates and Modules
10. Section 27 16 19 Communications Patch Cords and Station Cords
11. Section 27 21 33 Wireless Access Point Systems
12. Section 27 51 23 Educational Intercom and Program Clock System
13. Section 27 53 21 Distributed Antenna System – Public Safety

1.3 STANDARDS AND CODES:

- A. Refer to other sections in Division 27 00 00 – Communications
- B. Refer to Division 01 – Reference Standards and General Conditions of the Contract
- C. Complies with both ANSI/TIA-607-C and NEC Article 250. The most stringent rules apply.

1.4 APPROVED PRODUCT MANUFACTURERS:

- A. The manufacturer of hardware, devices, and components, that School District of Osceola County is using as basis of design in this document, as required for construction of the cabling infrastructure per contract documents shall be:
 1. Audio Enhancement
- B. This product has been approved by the School District of Osceola County School Board as a sole source solution for classroom amplification on August 20, 2013. Product substitutions from other manufacturers are not permitted without the express written permission and approval by the School District of Osceola County School Board.

1.5 SUBMITTALS:

- A. Shop Drawings:
 - 1 Shop drawings will indicate the location of cable routes, speaker locations, amplifier location, antenna location, associated hardware, and devices, and will require the approval of the Project Technology Designer (Project Electrical Engineer and Registered Communication Distribution Designer (RCDD)) and SDOC Technology Services Department Representative prior to implementation.
- B. Submit Manufacturer's Cut Sheets for the following (Refer to Section 27 00 00 – Communications Submittal):
 - 1 Major items not included in the Product Section.
 - 2 Submit for approval in accordance with specified submittal procedures:
 - a) Cable
 - b) Speakers
 - c) Amplifier
 - d) Brackets
 - e) Supports
 - f) Hardware

1.6 QUALITY ASSURANCE:

- A. Manufacturer (Audio Enhancement):
 - 1 Firm has regularly engaged in manufacture of the materials, called out for in this section, whose products have been in satisfactory use in similar service for not less than 3 years.
- B. The Contractor will install work in accordance with the latest School District of Osceola County Requirements, the latest BICSI Information Technology Systems Installation Methods Manual, Telecommunications Distribution Methods Manual, TIA/EIA Standard Commercial Building Telecommunications Cabling Standard, systems planning and design manual.
- C. The Contractor who is installing the materials and installing the system will be trained by the referenced manufacturer in the proper installation practices. The Contractor will have the proper tools and test equipment to insure a good and proper installation.
- D. Installed cabling system, pathways and distribution facilities will adhere to manufacturer's instructions, contract drawings, and specifications, and applicable codes, standards and regulations.
- E. Where applicable, all equipment, components, accessories and hardware will be UL listed for the intended purpose of the installation.
- F. All critical internal manufacturing operations for installed products will have documented in-process inspection and testing according to ISO9001.
- G. Installed products will be manufactured by an ISO9001 certified facility.
- H. Installed products will be free from defects in material or workmanship from the manufacturer and will be of the quality indicated.
- I. All methods of construction that are not specified in the contract documents will be subject to control and approval by the Project Technology Designer (RCDD) and SDOC Technology Services Department Representative.
- J. Installed products will be lot-traceable by date code.

1.7 DEFINITION:

- A. Classroom Amplification System:
 - 1 An amplification system that allows audio from teacher, student, or audio source to be amplified whereas all students and participants can hear a clear and concise audio sound within an educational environment.

1.8 WARRANTIES:

- A. Refer to Section 27 00 00 for general details.

1.9 MATERIALS:

- A. All materials shall be UL or ETL listed and verified and shall be marked as such.
- B. Products shall be regularly catalogued items of the manufacturer and shall be supplied as a complete unit in accordance with the manufacturer's standard specifications with any optional items required for proper installation unless otherwise noted.
 - 1. All materials used on this project shall be new. Used and refurbished equipment are not permitted. Provided equipment on site in original packaging whenever practical.

1.10 DELIVERY, STORAGE AND HANDLING LOGISTICS:

- A. Material shall be delivered to the site in the original packing.
- B. Materials delivered to the construction site shall be stored in a dry, secure area, preferably indoors. Storage temperature of materials shall adhere to manufacturer's recommendations. Movement of packaged materials shall be in a manner to avoid damage of contents. On-site storage, either indoors or trailer, shall have permission by the School District of Osceola County Staff, and shall not interfere with other construction activity.
- C. Installation of cable, speakers, and amplifier shall be within the recommended temperature range specified by the manufacturer. Cable installation temperature range between 50^of and 80^of is recommended. Cabling should only be installed in facilities that are not exposed to the elements.
- D. The Contractor is responsible for scheduling all deliveries and providing proper receipt, handling, and storage of all materials. Protect all equipment from physical damages (dents, scratches, dust, water, **paint**, chemicals, and temperature extremes) and vandalism, or theft. The Contractor shall replace any damaged or stolen equipment. The Contractor is responsible for all equipment until final project acceptance by the School District of Osceola County.
- E. The Contractor is responsible for cleaning the worksite every business day and removing debris from the facility.

1.11 COORDINATION WITH OTHER TRADES:

- A. Coordinate layout of work with other trades. Make minor adjustments in locations required for coordination. Locations of structural systems, heating work and plumbing lines shall take preference over locations of conduit lines where conflict occurs. Structural systems, heating work, and plumbing lines shall not interfere with or otherwise impede the routing of communication cabling with cable tray, raceways, or other pathways dedicated to communications. All potential issues shall be brought to the attention of the General Contractor, Construction Manager, Architect, Engineer, Project Technology Designer (RCDD), and SDOC Technology Services Department Representative immediately, before proceeding with installation.
- B. Other than minor issues, adjustments shall be submitted to the General Contractor, Construction Manager, Architect, Engineer, Project Technology Designer (RCDD), and SDOC Technology Services Department Representative for approval before proceeding with the work.
- C. Coordinate locations, arrangement, mounting, and support of all communications provisions with Division 26 Representative, Project Technology Designer (RCDD), and SDOC Technology Services Department Representative that:
 - 1. Allow maximum possible headroom unless specific mounting heights that reduce headroom are indicated.
 - 2. Provide for ease of disconnecting the equipment with minimum interference to other installations.
 - 3. Allow right of way for piping and conduit installed at required slope.
 - 4. Coordinate that connecting raceways, cables, and cable trays will be clear of obstructions and of the working and access space of other equipment.
 - 5. Coordinate installation of required supporting devices and set sleeves in cast-in-place concrete, masonry walls, and other structural components as they are constructed.
 - 6. Coordinate sleeve selection specified in Division 07 and Division 26.
 - 7. Coordinate location of access panels and doors for electrical items that are behind finished surfaces or otherwise concealed.
 - 8. Coordinate the gauge cables to be used in the telecommunications grounding system.

D. Audio Enhancement Contractor shall furnish and install the following:

- 1 Speakers
- 2 Cable, Copper
- 3 Amplifier
- 4 Microphones
- 5 Brackets
- 6 Pathways
- 7 Patch Cables
- 8 Support / Enclosures

E. Electrical Contractor shall furnish and install the following:

- 1 Conduit
- 2 Outlet Boxes
- 3 NEMA 120V R-20 duplex outlet
- 4 Sleeving (rated / non-rated barriers)

PART 2 PRODUCTS:

2.1 AUDIO ENHANCEMENT COMPONENTS:

- A. Speakers
- B. Cabling
- C. Amplifier

PART 3 EXECUTION:

3.1 GENERAL:

- A. Quantities of system elements shown on the drawings are illustrative only and are meant to indicate the general configuration of the work. The Contractor is responsible for providing the correct quantities of materials to construct a system that meets the intent of these Specifications and the relevant codes.
- B. Follow all manufacturers' instructions.
- C. Coordinate with all other trades prior to pre-construction submittals and installation.

3.2 LABELING:

- A. All labels shall be permanent, machine generated labels produced by a labeling machine. Labels shall be a permanent polyester material clear in color with label lettering black in color. No handwritten labels will be accepted.
- B. Labeling information will be reviewed at pre-installation meeting, and the Project Technology Designer (Project Electrical Engineer and Registered Communications Distribution Designer (RCDD)) and SDOC Technology Services Department Representative shall approve the labeling scheme prior to the installation of any cabling.
- C. Surfaces shall be cleaned before attaching labels. All labels shall be attached firmly and vertically plumb on equipment.
- D. All labeling of cables, equipment, and components shall be included in as-built documentation, floor plan drawings, and schematic designs.

3.3 INSTALLATION:

- A. All Manufacturer's care and installation instructions will be followed.

END OF SECTION 27 41 16

[REMAINDER OF PAGE INTENTIONALLY LEFT BLANK]

EDUCATION INTERCOM AND PROGRAM CLOCK SYSTEM

PART 1 GENERAL:

1.1 INTRODUCTION :

A. Education Intercom and Program Clock System:

1. The work covered by this section of the Specifications includes all labor necessary to perform and complete such construction, all materials and equipment incorporated or to be incorporated in such construction and all services, facilities, tools and equipment necessary or used to perform and complete such construction. The work of this section shall include, but is not limited to, the following:
 - a) Education Intercom and Program Clock System, including speakers, microphones, amplifiers, modules, associated hardware, and devices in accordance with the strictest manufacturer written recommendation per code or the best industry practice. These communication specifications are requirements for all School District of Osceola County (SDOC) projects. Request for deviations from these guides and requirements must be made in writing to the School Board of Osceola County.

1.2 RELATED DOCUMENTS:

A. Division 27 Sections that apply to this Section are:

1. Section 27 00 00 Communications
2. Section 27 05 26 Grounding & Bonding for Communications Systems
3. Section 27 05 28 Pathways for Communications Systems
4. Section 27 05 36 Cable Trays for Communications Systems
5. Section 27 11 10 Telecommunications Spaces, Equipment and Fittings
6. Section 27 13 13 Communications Copper Backbone Cabling
7. Section 27 13 23 Communications Optical Fiber Backbone Cabling
8. Section 27 15 13 Communications Copper Horizontal Cabling
9. Section 27 15 43 Communications Faceplates and Modules
10. Section 27 16 19 Communications Patch Cords and Station Cords
11. Section 27 21 33 Wireless Access Point Systems
12. Section 27 41 16 Classroom Amplification System
13. Section 27 53 21 Distributed Antenna System - Public Safety

1.3 STANDARDS AND CODES:

- A. Refer to other sections in Division 27 00 00 - Communications
- B. Refer to Division 01 - Reference Standards and General Conditions of the Contract
- C. Complies with both ANSI/TIA-607-C and NEC Article 250. The most stringent rules apply.

1.4 APPROVED PRODUCT MANUFACTURERS:

- A. The manufacturer of hardware, devices, and components, that School District of Osceola County is using as basis of design in this document, as required for construction of the cabling infrastructure per contract documents shall be:
 1. Rauland-Borg Telecenter U
 2. Hubbell Premise Wiring
- B. This product has been approved by the School District of Osceola County School Board as a sole source solution for Education Intercom and Program Clock System on April 3, 1990. Product substitutions from other manufacturers are not permitted without the express written permission and approval by the School District of Osceola County School Board.

- C. Product substitutions from other manufacturers shall require the approval of the Project Technology Designer (Project Electrical Engineer and Registered Communication Distribution Designer (RCDD)) and SDOC Technology Services Department Representative 10 business days prior to bid opening.

1.5 SUBMITTALS:

- A. Shop Drawings:
 - 1 Shop drawings will indicate the location of cable routes, speaker locations, amplifier location, associated hardware, and devices, and will require the approval of the Project Technology Designer (Project Electrical Engineer and Registered Communication Distribution Designer (RCDD)) and SDOC Technology Services Department Representative prior to implementation.
- B. Submit Manufacturer's Cut Sheets for the following (Refer to Section 27 00 00 – Communications Submittal):
 - 1 Major items not included in the Product Section.
 - 2 Submit for approval in accordance with specified submittal procedures:
 - a) Cable
 - b) Speakers – internal / external
 - c) Notification interface devices
 - d) Brackets
 - e) Supports
 - f) Hardware
 - g) Patch Panels
 - h) Transition blocks
 - i) Modules
 - j) Amplifiers
 - k) Input / Output interface devices
 - l) Patch Cords
 - m) Transmitters
 - n) Gateways

1.6 QUALITY ASSURANCE:

- A. Manufacturer:
 - 1 Firm has regularly engaged in manufacture of the materials, called out for in this section, whose products have been in satisfactory use in similar service for not less than 3 years.
- B. The Contractor will install work in accordance with the latest School District of Osceola County Requirements, the latest BICSI Information Technology Systems Installation Methods Manual, Telecommunications Distribution Methods Manual, TIA/EIA Standard Commercial Building Telecommunications Cabling Standard, systems planning and design manual.
- C. The Contractor who is installing the materials and installing the system will be trained by the referenced manufacturer in the proper installation practices. The Contractor will have the proper tools and test equipment to insure a good and proper installation.
- D. Installed UTP cabling systems, pathways and distribution facilities will adhere to manufacturer's instructions, contract drawings and specifications, and applicable codes, standards, and regulations.
- E. Installed UTP cabling systems and field test results will strictly adhere to requirements of ANSI/TIA-568-0.D, ANSI/TIA-568-1.D and ANSI/TIA/EIA-568-2.D.
- F. Where applicable, all equipment, components, accessories, and hardware will be UL listed for the intended purpose of the installation.
- G. All critical internal manufacturing operations for installed products will have documented in-process inspection and testing according to ISO9001.
- H. Installed products will be manufactured by an ISO9001 certified facility.

- I. Installed products will be free from defects in material or workmanship from the manufacturer and will be of the quality indicated.
- J. All methods of construction that are not specified in the contract documents will be subject to control and approval by the Project Technology Designer (RCDD) and SDOC Technology Services Department Representative.
- K. Installed products will be lot-traceable by date code.

1.7 DEFINITION:

- A. Educational Intercom System:
 - 1 A communication system that allows for general announcements, two-way speech between educational environment and Administration, critical notifications, and visual components for immediate verification of classroom safety.
- B. Program Clock System
 - 1 A time keeping system that allows for campus-wide synchronized clock interface with uniformed time updates from a central source.

1.8 WARRANTIES:

- A. Refer to Section 27 00 00 for general details.

1.9 MATERIALS:

- A. All materials shall be UL or ETL listed and verified and shall be marked as such.
- B. Products shall be regularly catalogued items of the manufacturer and shall be supplied as a complete unit in accordance with the manufacturer's standard specifications with any optional items required for proper installation unless otherwise noted.
 - 1 All materials used on this project shall be new. Used and refurbished equipment are not permitted. Provided equipment on site in original packaging whenever practical.

1.10 DELIVERY, STORAGE AND HANDLING LOGISTICS:

- A. Material shall be delivered to the site in the original packing.
- B. Materials delivered to the construction site shall be stored in a dry, secure area, preferably indoors. Storage temperature of materials shall adhere to manufacturer's recommendations. Movement of packaged materials shall be in a manner to avoid damage of contents. On-site storage, either indoors or trailer, shall have permission by the School District of Osceola County Staff, and shall not interfere with other construction activity.
- C. Installation of cable, speakers, modules, components, devices, gateways, and amplifier shall be within the recommended temperature range specified by the manufacturer. Cable installation temperature range between 50^of and 80^of is recommended. Cabling should only be installed in facilities that are not exposed to the elements.
- D. The Contractor is responsible for scheduling all deliveries and providing proper receipt, handling, and storage of all materials. Protect all equipment from physical damages (dents, scratches, dust, water, **paint**, chemicals, and temperature extremes) and vandalism, or theft. The Contractor shall replace any damaged or stolen equipment. The Contractor is responsible for all equipment until final project acceptance by the School District of Osceola County.
- E. The Contractor is responsible for cleaning the worksite every business day and removing debris from the facility.

1.11 COORDINATION WITH OTHER TRADES:

- A. Coordinate layout of work with other trades. Make minor adjustments in locations required for coordination. Locations of structural systems, heating work and plumbing lines shall take preference over locations of conduit lines where conflict occurs. Structural systems, heating work, and plumbing lines shall not interfere with or otherwise impede the routing of communication cabling with cable tray, raceways, or other pathways dedicated to communications. All potential issues shall be brought to the attention of the General Contractor, Construction Manager, Architect, Engineer, Project Technology Designer (RCDD), and SDOC Technology Services Department Representative immediately, before proceeding with installation.
- B. Other than minor issues, adjustments shall be submitted to the General Contractor, Construction Manager, Architect, Engineer, Project Technology Designer (RCDD), and SDOC Technology Services Department Representative for approval before proceeding with the work.

- C. Coordinate locations, arrangement, mounting, and support of all communications provisions with Division 26 Representative, Project Technology Designer (RCDD), and SDOC Technology Services Department Representative that:
 - 1. Allow maximum possible headroom unless specific mounting heights that reduce headroom are indicated.
 - 2. Provide for ease of disconnecting the equipment with minimum interference to other installations.
 - 3. Allow right of way for piping and conduit installed at required slope.
 - 4. Coordinate that connecting raceways, cables, and cable trays will be clear of obstructions and of the working and access space of other equipment.
 - 5. Coordinate installation of required supporting devices and set sleeves in cast-in-place concrete, masonry walls, and other structural components as they are constructed.
 - 6. Coordinate sleeve selection specified in Division 07 and Division 26.
 - 7. Coordinate location of access panels and doors for electrical items that are behind finished surfaces or otherwise concealed.
 - 8. Coordinate the gauge cables to be used in the telecommunications grounding system.
- D. Rauland-Borg Contractor shall furnish and install the following:
 - 1. Speakers
 - 2. Clocks
 - 3. Transmitter (with FCC Licensing)
 - 4. Components / Modules
 - 5. Devices / Interfaces
 - 6. Cable, Copper
 - 7. Amplifier
 - 8. Brackets
 - 9. Pathways
 - 10. Patch Cables
 - 11. Support / Trays / Hardware
- E. Electrical Contractor shall furnish and install the following:
 - 1. Conduit
 - 2. Outlet Boxes
 - 3. Penetrations
 - 4. Mechanical Firestop devices
 - 5. Sleeving (rated / non-rated barriers)
- F. Unless otherwise noted, the following items will be the responsibility of the School District of Osceola County:
 - 1. All electronics and active data networking equipment, etc.
 - 2. All port assignments for Intercom interface.
 - 3. All port assignments for Synchronized Clock interface.

PART 2 PRODUCTS:

2.1 CABLE:

- A. Category 6 UTP:
 - a) 4-pair, category 6, unshielded twisted pairs (UTP), 23 AWG, bare copper, polyethylene insulated conductors, with overall Yellow Jacket (General Data) or Green (External Intercom Speaker and common area speakers, etc.):
 - b) Rate to 550 MHz

- c) TIA PARAMETER HEADROOM
 - d) NEXT loss +3 dB
 - e) PSNEXT loss +3 dB
 - f) ACRF +3 dB
 - g) PSACRF +3 dB
 - h) PoE, PoE+
 - i) TIA Component Compliant
 - j) Cables shall be terminated on modular jacks in equipment frames
- B. UTP Patch Panels, Category 6 (Intercom Systems):
1. Panel shall be constructed of 16-gauge steel, rolled edge construction with black powder coat finish
 2. Panel shall be standard 19-inch rack mount
 3. Panels comply with EIA-310-D rack mount standards
- C. Category 6 Jacks:
1. Jacks shall be standard 8-position, RJ-45 style, un-keyed, FCC compliant
 2. Each jack shall be single unit construction, with snap – fit to industry standard keystone opening (.760” x .580”)
 3. Jack housings shall be high impact UL 94 v-0 rated thermoplastic
 4. Jacks shall have a temperature rating of -10°C (14°F) to 70°C (158°F)
 5. Jack housings shall fully encase and protect printed circuit boards and IDC fields
 6. Housings shall be ultrasonically welded for tamper resistance
 7. Modular jack contacts shall accept a minimum of 2000 mating cycles without degradation of electrical or mechanical performance
 8. Jack contacts shall maintain a minimum deflection force of 100 grams while mated with an FCC-standard RJ-45 plug
 9. Jack contacts shall be formed flat for increased surface contact with mated plugs
 10. Jack contacts shall be constructed of beryllium copper for maximum spring force and durability. Contact plating shall be a minimum of 50 micro-inches of hard gold in the contact area over 50 micro-inches of nickel
 11. Jack termination method shall follow the industry standard 110 IDC punch-down. Jacks shall be compatible with single conductor standard 110 impact termination tools
 12. Jacks shall be compatible with a 4-pair single punch impact tool designed specifically for the purpose
 13. Jacks shall have their category rating designation, visible from the front when installed
 14. Bottom of jack shall have date code and an abbreviated catalog number
 15. Jacks shall terminate 26-22 awg solid conductors
 16. Jacks shall not require special cords, specialty tools or special installation requirements
 17. Stuffer cap shall have retention snaps to assure conductor strain relief
 18. Jacks shall accept optional hinged dust covers
 19. Jacks shall be compatible with ANSI/TIA-606-B color code labeling
 20. Jacks shall accept snap-on icons for specific identification
 21. Jacks shall be available in various colors to meet specific customer applications
 22. Jacks shall have attached wiring instruction labels to permit T568a wiring configurations
 23. Category rated jacks shall be backward compatible for fit, form, and function
 24. Jacks shall be **manufactured in the USA**

25. All transmission performance parameters shall be independently verified by a UL or ETL third party testing organization
26. Jacks shall be UL listed 1863 and CSA certified
27. Jacks shall exceed IEEE 802.3af DTE power specification to 4 times the rated current limits with no degradation of performance or materials
28. Jacks shall exceed IEEE802.3bt DTE power specification
29. Jacks shall be third party verified, to meet or exceed performance requirements
30. Component rated per ANSI/TIA-568.2-D
31. Colors to specified by end user

2.2 TELECENTER U OVERVIEW:

A. General:

1. This web-based system shall provide state of the art technology for all intercom communications, emergency notification, life safety paging, and evacuation tones and alerts.
2. This web-based system shall be easy to learn and operate. All standard system programming shall be user friendly to allow the system administrator the ability to easily program system features.
3. All Equipment shall be provided with all required power supplies, cables, connectors, and interfaces as required for a complete and functional system.
4. See contract drawings for all product requirements not indicated in these specifications.

2.3 PERFORMANCE REQUIREMENTS:

- A. Intercom System shall provide for distribution and activation of a status light module located outside each educational location for visual confirmation that an event has occurred, response to an event has been acknowledged, and / or escalation of an event is necessary; as indicated by Project Technology Designer (RCDD) and SDOC Technology Services Department Representative. Verify all requirements with conformed documents assigned to the project.
- B. Intercom System shall provide for distribution to remote speakers all class change signaling tones and class change tones (including any pre-recorded announcements, music, or notifications) to all speakers within the system, including educational locations, outside speakers, common areas, staff areas, student toilet areas, and administrative areas as indicated by Project Technology Designer (RCDD) and SDOC Technology Services Department Representative. Verify all requirements with conformed documents assigned to the project.
- C. Intercom System shall provide for distribution of alert tones, notification tones, evacuation tones, and assist with Fire Alarm signals to remote speakers in all locations throughout the campus as indicated by Project Technology Designer (RCDD) and SDOC Technology Services Department Representative. Verify all requirements with conformed documents assigned to the project.
- D. Intercom System speakers shall be tapped for individual room requirements. Speakers shall be tapped, main system amplifier sized, and overall system balanced to allow minor system adjustments after installation has been substantially completed. In no instance shall any speaker be tapped to its minimum or maximum setting prior to final adjustments. Minimum tap setting shall be reserved for volume adjustment in undersized rooms. In no instance shall any speaker control assembly be loaded in excess of eighty percent (80%) of the manufacturers stated full load capacity rating.
- E. Program Clock System shall include Synchronized Master Clock Transmitter with access to a Universal Time keeping source, independent clock receivers, devices, components, and associated hardware as indicated by Project Technology Designer (RCDD) and SDOC Technology Services Department Representative. Verify all requirements with conformed documents assigned to the project.
- F. Intercom Primary System controller and Master Clock Transmitter equipment shall be installed in the rack and on the backboard location in the CD (MDF) location as indicated by Project Technology Designer (project Electrical Engineer and Registered Communication Distribution Designer (RCDD)) and SDOC Technology Services Department Representative. Verify all requirements with conformed documents assigned to the project.
- G. Auxiliary Intercom System equipment shall be installed in the rack and on backboard locations in the FD (IDF) locations as indicated by Project Technology Designer (RCDD) and SDOC Technology Services Department Representative. Verify all requirements with conformed documents assigned to the project.
- H. Intercom System shall be accessible from any VoIP communication device location through-out the campus,

from any designated District Administration Personnel, and as indicated by Project Technology Designer (RCDD) and SDOC Technology Services Department Representative. Verify all requirements with conformed documents assigned to the project.

2.4 SYSTEM OPERATION REQUIREMENTS:

- A. The System shall provide, as a minimum, the following functions:
 1. Provide at least two simultaneous speech paths between Administrative control stations or telephone instrument (connected to DTMF telephone system) and classroom speakers.
 2. Provide simultaneous use of one (1) program channel and two (2) intercom channels.
 3. Provide 2-way voice communication directly between any administration control station and any remote speaker, another administration control center, or any remote classroom speaker / microphone module.
 4. Administration Console will receive all classroom calls and be able to extend, hold, or announce the call. Any location initiating a call will display the calling room number on a 16-character alpha / numeric LCD readout.
 5. Room extension numbers shall all be programmable and may be assigned any alpha / number from 000001 – 899999. Any room extension may be reassigned at any time and is not dependent on wiring or circuit numbers.
 6. Initiate priority call to office.
 7. Programming of above functions shall be using a WAN based programming tool enabling the owner to perform programming from a remote location (e.g. District Office).
 8. Call origination shall require only the momentary depression of the call origination switch, which will sound a tone at the origination speaker / microphone module, at the Administration Console, and display the room number on the alpha-numerical LCD readout.
 9. Eight (8) inch speakers shall be provided in each educational area, staff area, administrative area, hallways, student toilet areas, and common areas. Speakers are not required in single person toilets.
 10. Weatherproof Flush mounted speakers shall be provided around the outside of the building (as indicated by conformed documents) at a maximum distance between each speaker of twenty (20) linear feet and a maximum height of ten (10) feet above finished grade.
 11. System amplifiers shall be capable of providing sufficient volume for emergency paging of all speakers with a twenty percent (20%) reserved capacity for future expansion.
 12. A user programmable clock shall be incorporated into the system, which will provide multiple separate schedules. Clock shall activate tone generator for all class change signals. Class change signals shall sound as chimes over inside speakers and tones through outside speakers.
 13. All control equipment shall be installed in assigned two-post rack position, in the CD (MDF) / FD (IDF) and backboard locations, as indicated by Project Technology Designer (RCDD) and SDOC Technology Services Department Representative. Verify all requirements with conformed documents assigned to the project.
 14. The Administration Console shall be located in offices, typically front office, Principal's office, and / or Dean's office (where applicable) as indicated by Project Technology Designer (RCDD) and SDOC Technology Services Department Representative. Verify all requirements with conformed documents assigned to the project.

2.5 COMPONENT REQUIREMENT:

- A. The Intercom System shall include, as indicated by Project Technology Designer (RCDD) and SDOC Technology Services Department Representative, the following:
 1. TCU Controller
 2. Zone Page Module
 3. IP Module
 4. Speaker
 5. Notification Module
 6. Volume Control
 7. Horn

8. Patton Boxes (interface with VoIP system)
9. Amplifier
10. Status Light Module
11. Wireless Synchronized Clocks
12. Master Clock Transmitter (with FCC licensing)
13. Associated Hardware
14. Cable

2.6 NETWORK REQUIREMENT:

- A. The SDOC Technology Services Department Representative shall create documentation for the creation of port access assignments within the SDOC domain allowing the TCU Controller the ability to communicate with each TCU dependent module, component and device prior to testing and implementation of the Education Intercom and Program Clock Systems. Rauland-Borg of Florida, installer, shall provide all documentation required by SDOC Technology Services Department Networking to facilitate said assignments (I.E. mac addresses of modules, devices, and components) in a timely manner.

PART 3 EXECUTION:

3.1 GENERAL:

- A. Quantities of system elements shown on the drawings are illustrative only and are meant to indicate the general configuration of the work. The Contractor is responsible for providing the correct quantities of materials to construct a system that meets the intent of these Specifications and the relevant codes.
- B. Follow all manufacturers' instructions.
- C. Coordinate with all other trades prior to pre-construction submittals and installation.

3.2 LABELING:

- A. All labels shall be permanent, machine generated labels produced by a labeling machine. Labels shall be a permanent polyester material clear in color with label lettering black in color. No handwritten labels will be accepted.
- B. Labeling information will be reviewed at pre-installation meeting, and the Project Technology Designer (Project Electrical Engineer and Registered Communications Distribution Designer (RCDD)) and SDOC Technology Services Department Representative shall approve the labeling scheme prior to the installation of any cabling.
- C. Surfaces shall be cleaned before attaching labels. All labels shall be attached firmly and vertically plumb on equipment.
- D. All labeling of cables, equipment, and components shall be included in as-built documentation, floor plan drawings, and schematic designs.

3.3 INSTALLATION:

- A. All Manufacturer's care and installation instructions will be followed.
- B. Refer to Division 27 Section 27 15 13 – Communications Horizontal Copper Cabling
- C. Material and Installation shall be provided by Rauland-Borg of Florida.
- D. All patch cords shall be factory manufactured. **NO** on-site patch cords shall be created or deployed – **NO EXCEPTIONS**
- E. All cabling shall be terminated within a patch panel, **green** jacks shall be employed, and shall be connected to network switches via **green** patch cords. No direct connection from field to network work switch shall be permitted – **NO EXCEPTIONS**

END OF SECTION 27 51 23

[REMAINDER OF PAGE INTENTIONALLY LEFT BLANK]

DISTRIBUTED ANTENNA SYSTEM (DAS) – PUBLIC SAFETY

PART 1 GENERAL:

1.1 INTRODUCTION :

A. Distributed Antenna System:

1. The work covered by this section of the Specifications includes all labor necessary to perform and complete such construction, all materials and equipment incorporated or to be incorporated in such construction and all services, facilities, tools and equipment necessary or used to perform and complete such construction. The work of this section shall include, but is not limited to, the following:
 - a) Distributed Antenna System, associated hardware and devices created in accordance with the strictest manufacturer written recommendation per code or the best industry practice. These communication specifications are requirements for all School District of Osceola County (SDOC) projects. Request for deviations from these guides and requirements must be made in writing to the School Board of Osceola County.

1.2 RELATED DOCUMENTS:

A. Division 27 Sections that apply to this Section are:

1. Section 27 00 00 Communications
2. Section 27 05 26 Grounding & Bonding for Communications Systems
3. Section 27 05 28 Pathways for Communications Systems
4. Section 27 05 36 Cable Trays for Communications Systems
5. Section 27 11 10 Telecommunications Spaces, Equipment and Fittings
6. Section 27 13 13 Communications Copper Backbone Cabling
7. Section 27 13 23 Communications Optical Fiber Backbone Cabling
8. Section 27 15 13 Communications Copper Horizontal Cabling
9. Section 27 15 43 Communications Faceplates and Modules
10. Section 27 16 19 Communications Patch Cords and Station Cords
11. Section 27 21 33 Wireless Access Point Systems
12. Section 27 41 16 Classroom Amplification System
13. Section 27 51 23 Education Intercom and Program Clock System

1.3 STANDARDS AND CODES:

- A. Refer to other sections in Division 27 00 00 – Communications
- B. Refer to Division 01 – Reference Standards and General Conditions of the Contract
- C. Complies with both ANSI/TIA-607-C and NEC Article 250. The most stringent rules apply.

1.4 DESIGN CRITERIA:

- A. System shall meet the requirements of the AHJ for Public Safety Radio Amplification Systems.
- B. Active signal handling:
 1. The in-building wireless system shall have active elements that filter and amplify signals on a frequency specific basis to consistently deliver wireless services at the appropriate power levels.

- C. Frequency Range:
1. The system shall support all frequencies between 400 MHz to 2500 MHz
 2. The system shall distribute RF coverage at levels outline below in the following areas of the building(s) – herein specified coverage areas:
 - a) Floor areas including corridors, lobbies, concourse, and interstitial spaces
 - b) Corridors and lobbies
 - c) Bridges / Building links
 - d) Stairwells
 - e) Elevator lobbies
 - f) General Use spaces (break rooms, staff rooms)
 - g) Restrooms
 - h) Exterior public spaces (e.g., courtyards)
 - i) No areas are excluded
- D. The in-building wireless system shall support:
1. Public Safety Radio Enhancement / Emergency Responder:
 - a) The system shall distribute Public Safety channels with a signal strength that exceeds the minimum requirements specified by the AHJ or -.95dBm. Public Safety local and city police, county sheriff, emergency medical services, and fire / rescue departments.
 - b) 95 percent (95%) coverage of all areas of each building level
 - c) UHF (450-520 MHz)
 - d) LMR 700/800 MHz – Land Mobile Radio
 - e) Frequencies for the following radio systems shall be supported. The DAS vendor shall confirm the frequencies required at the time of facility opening:
 - 1) Federal SDH Trunk, 406.1 – 420 MHz NB
 - 2) DVAMC Police 407.0750, 412.3875, and 416.0750 MHz
 - 3) Local Police Departments
 - 4) County Sheriff
 - 5) Fire Departments
 - 6) Internal Facilities
 - E. The system shall have the capability for separate control over each service (or wireless operator) to allow the ability to adjust and control power levels without disturbing other services / operators
 - F. The system shall support multiple services in a modular architecture so services can be added or removed without requiring a new infrastructure, without readjustment of signal power levels, or disturbing existing services.
 - G. The system shall enable services to be added without requiring additional cabling or antennas.
 - H. The system shall not impede any management features or functionality of any attached network and / or device management system. The system shall allow for proactive management and end-to-end alarming of active equipment components, resulting in rapid problem identification and resolution. The system shall be able to integrate with 3rd party SNMP based element management systems via Ethernet and provide fault management information.

- I. Cellular Services:
 - 1. The system's transmission media can take many forms, from traditional off-air repeater, or Base Transceiver Station (BTS) to tethered architecture consisting of coaxial, fiber optic, or hybrid fiber / coaxial base solution. The Distributed Antenna System (DAS) shall extend the common wireless carrier services from the head end system by interfacing to either a passive or active Distributed Antenna System (DAS) that is deployed in each of the building structures. The following system solution designs are meant to be typical only. Bidders are expected to describe their proposed system solutions.
 - 2. The system shall support the use of legacy cellular enhancement and technologies such as GSM, EDGE, and Universal Mobile Telecommunications Systems – High Speed Packet Access (UMTS-HSPA) technologies.
 - 3. The GPS navigational signal must be brought to the base station at the system's head end to support Local Base Services functionality.
- J. The system and the associated wireless devices shall comply with FCC's and Regional regulatory authorities' emission rules for wireless devices:
 - 1. Refer to FCC advisory "A Local Government Official's Guide to Transmitting Antenna RF Emission Safety Rules, Procedures, and Practical Guidance", FCC's OET Bulletin 65, FCC Rule 47 part 17, and (ANSI/IEEE C95.1-1992) Hazardous Emission Document.
- K. Product substitutions from other manufacturers shall require the approval of the Project Technology Designer (Project Electrical Engineer and Registered Communication Distribution Designer (RCDD)) and SDOC Technology Services Department Representative 10 business days prior to bid opening.

1.5 SUBMITTALS:

- A. Shop Drawings:
 - 1. Shop drawings will indicate the location of cable routes, speaker locations, amplifier location, associated hardware, and devices, and will require the approval of the Project Technology Designer (Project Electrical Engineer and Registered Communication Distribution Designer (RCDD)) and SDOC Technology Services Department Representative prior to implementation.
- B. Submit Manufacturer's Cut Sheets for the following (Refer to Section 27 00 00 – Communications Submittal):
 - 1. Major items not included in the Product Section.
 - 2. Submit for approval in accordance with specified submittal procedures:
 - a) Initial site wireless survey report
 - b) Detailed textual narrative with sufficient detail to illustrate the proposed system
 - c) Detailed system one-line or functional block / line diagrams
 - d) Plans indicating equipment, antenna, and / or component locations, cable routes, and other installation information – Identify construction elements that would affect the system's performance (such as metallic ceiling materials)
 - e) Predictive modeling coverage plans, showing the design RF coverage (signal strength) for each frequency band required in 1.04 B.3
 - f) Cellular coverage information that will include dBm above the exterior macro. Note that 700 MH no requires –75 dBm MIMO. 2x2 throughout the cellular coverage areas
 - g) Equipment, wall and rack elevations, showing equipment layout, pathway, power, cooling, and space requirements of the system and for the wireless service providers and integration with other systems outside the scope of the Distributed Antenna System (e.g., Fire Alarm Systems, Ethernet network monitoring)
 - h) Installation details for antenna mounting, specialty cable hangers, grounding, and other components unique to the system, and other information that depicts the intended installation
 - i) Design data furnished by the Contractor shall be sufficient to enable the Engineer to determine whether the equipment, materials, and installation proposed complies with the requirements of this Specification

3. Substitutions:
 - a) Requests for substitutions shall conform to the general requirements and procedure outlined in Division 27 00 00 – Communications
4. Submittal Requirements Prior to Acceptance Testing:
 - a) Acceptance Testing Procedures Submittal: describe in detail the procedure for testing the system's performance and balancing the system's signal strength, including a description of the test data (or an example of the test report)
 - b) Contractor shall demonstrate the desired services which have been successfully deployed and tested. Specifically, the Distributed Antenna System must be deployed with the Wireless Operators criteria and approval
5. Submittal Requirements at Close Out:
 - a) As-Built Drawings submittal
 - b) Record Drawings submittal
 - c) Operations and Maintenance Manual (refer to Division 27 00 00 – Communications)
 - d) Integration of components and pathways into the Building Information Model (BIM)

C. Sustainable Design Submittals:

1. Submit the necessary documentation to verify compliance with requirements specified in Section 01 81 11 – Sustainable Design Requirements

1.6 OPERATION AND MAINTENANCE MANUALS:

- A. Submit in accordance with Division 27 00 00 – Communications

1.7 QUALITY ASSURANCE:

- A. Manufacturer:
 1. Firm has regularly engaged in manufacture of the materials, called out for in this section, whose products have been in satisfactory use in similar service for not less than 3 years.
- B. The Contractor will install work in accordance with the latest School District of Osceola County Requirements, the latest BICSI Information Technology Systems Installation Methods Manual, Telecommunications Distribution Methods Manual, TIA/EIA Standard Commercial Building Telecommunications Cabling Standard, systems planning and design manual.
- C. The Contractor who is installing the materials and installing the system will be trained by the referenced manufacturer in the proper installation practices. The Contractor will have the proper tools and test equipment to insure a good and proper installation.
- D. Installed UTP cabling systems, pathways and distribution facilities will adhere to manufacturer's instructions, contract drawings and specifications, and applicable codes, standards, and regulations.
- E. Installed UTP cabling systems and field test results will strictly adhere to requirements of ANSI/TIA-568-0.D, ANSI/TIA-568-1.D and ANSI/TIA/EIA-568-2.D.
- F. Where applicable, all equipment, components, accessories, and hardware will be UL listed for the intended purpose of the installation.
- G. All critical internal manufacturing operations for installed products will have documented in-process inspection and testing according to ISO9001.
- H. Installed products will be manufactured by an ISO9001 certified facility.
- I. Installed products will be free from defects in material or workmanship from the manufacturer and will be of the quality indicated.
- J. All methods of construction that are not specified in the contract documents will be subject to control and approval by the Project Technology Designer (RCDD) and SDOC Technology Services Department Representative.

K. Installed products will be lot-traceable by date code.

1.8 DEFINITION:

A. Distributed Antenna System:

1. The in-building wireless system shall reliably distribute RF signals and wireless services throughout the specified frequency ranges and throughout the specified coverage spaces.

1.9 WARRANTIES:

A. Refer to Section 27 00 00 for general details.

1.10 MATERIALS:

A. All materials shall be UL or ETL listed and verified and shall be marked as such.

B. Products shall be regularly catalogued items of the manufacturer and shall be supplied as a complete unit in accordance with the manufacturer's standard specifications with any optional items required for proper installation unless otherwise noted.

1. All materials used on this project shall be new. Used and refurbished equipment are not permitted. Provided equipment on site in original packaging whenever practical.

1.11 DELIVERY, STORAGE AND HANDLING LOGISTICS:

A. Material shall be delivered to the site in the original packing.

B. Materials delivered to the construction site shall be stored in a dry, secure area, preferably indoors. Storage temperature of materials shall adhere to manufacturer's recommendations. Movement of packaged materials shall be in a manner to avoid damage of contents. On-site storage, either indoors or trailer, shall have permission by the School District of Osceola County Staff, and shall not interfere with other construction activity.

C. Installation of cable, antenna, modules, components, and devices shall be within the recommended temperature range specified by the manufacturer. Cable installation temperature range between 50°F and 80°F is recommended. Cabling should only be installed in facilities that are not exposed to the elements.

D. The Contractor is responsible for scheduling all deliveries and providing proper receipt, handling, and storage of all materials. Protect all equipment from physical damages (dents, scratches, dust, water, paint, chemicals, and temperature extremes) and vandalism, or theft. The Contractor shall replace any damaged or stolen equipment. The Contractor is responsible for all equipment until final project acceptance by the School District of Osceola County.

E. The Contractor is responsible for cleaning the worksite every business day and removing debris from the facility.

1.12 COORDINATION WITH OTHER TRADES:

A. Coordinate layout of work with other trades. Make minor adjustments in locations required for coordination. Locations of structural systems, heating work and plumbing lines shall take preference over locations of conduit lines where conflict occurs. Structural systems, heating work, and plumbing lines shall not interfere with or otherwise impede the routing of communication cabling with cable tray, raceways, or other pathways dedicated to communications. All potential issues shall be brought to the attention of the General Contractor, Construction Manager, Architect, Engineer, Project Technology Designer (RCDD), and SDOC Technology Services Department Representative immediately, before proceeding with installation.

B. Other than minor issues, adjustments shall be submitted to the General Contractor, Construction Manager, Architect, Engineer, Project Technology Designer (RCDD), and SDOC Technology Services Department Representative for approval before proceeding with the work.

C. Coordinate locations, arrangement, mounting, and support of all communications provisions with Division 26 Representative, Project Technology Designer (RCDD), and SDOC Technology Services Department Representative that:

1. Allow maximum possible headroom unless specific mounting heights that reduce headroom are indicated.
2. Provide for ease of disconnecting the equipment with minimum interference to other installations.
3. Allow right of way for piping and conduit installed at required slope.

4. Coordinate that connecting raceways, cables, and cable trays will be clear of obstructions and of the working and access space of other equipment.
 5. Coordinate installation of required supporting devices and set sleeves in cast-in-place concrete, masonry walls, and other structural components as they are constructed.
 6. Coordinate sleeve selection specified in Division 07 and Division 26.
 7. Coordinate location of access panels and doors for electrical items that are behind finished surfaces or otherwise concealed.
 8. Coordinate the gauge cables to be used in the telecommunications grounding system.
- D. Distributed Antenna System Contractor shall furnish and install the following:
1. All components / devices / hardware required for a complete and operational system.
- E. Electrical Contractor shall furnish and install the following:
1. Conduit
 2. Outlet Boxes
 3. 120V 20R power receptacle(s)
 4. Penetrations
 5. Mechanical Firestop devices
 6. Sleeving (rated / non-rated barriers)
- F. Unless otherwise noted, the following items will be the responsibility of the School District of Osceola County:
1. All electronics and active data networking equipment, etc.

PART 2 PRODUCTS:

2.1 COMPONENTS:

- A. All copper and fiber optic cables shall be plenum rated. Match cable requirements indicated elsewhere in Division 27, unless otherwise indicated
1. Fiber optic transport:
 - a) In-building Wireless System shall utilize single-mode fiber optic cabling as indicated elsewhere in Division 27.
 2. Broadband (coaxial) distribution:
 - a) In-building Wireless system shall utilize coaxial cable in the horizontal runs and passive (i.e. non-powered) broadband antennae in the distribution area.

2.2 OMNI-DIRECTIONAL COVERAGE:

- A. Omni-Directional Coverage antennas shall feature a multi-band design, accommodating multiple frequency bands in a single small antenna:
1. Electrical Band 1:
 - a) Frequency Band: 698 – 800 MH
 - b) VSWR: $\leq 1.8:1$
 - c) Gain: ≥ 1.5 dBi
 - d) Maximum input power
 - e) Impedance : 50 Ω
 - f) Beamwidth, Horizontal: 360° omnidirectional
 - g) Beamwidth, Vertical: 80° nominal

- h) Return Loss: 10.9 dB
2. Electrical Band 2”
 - a) Frequency Band: 1710 – 2700 MHz and 800 – 960 MHz
 - b) VSWR: $\leq 1.5:1$
 - c) Gain: ≥ 1.5 dBi @ 800 – 960 MHz and ≤ 5.0 dBi @ 1710 2700 MHz
 - d) Maximum input power
 - e) Impedance: 50 Ω
 - f) Beamwidth, Horizontal: 3600 omnidirectional
 - g) Beamwidth, Vertical: 65° nominal
 - h) Return Loss: ≤ 13.9 dB
 3. Mechanical:
 - a) Connector: 50 Ω N Type Female
 - b) Mounting: Thru-hole ceiling mount
 - c) Radome material: ABS, UV resistant
 - d) Pigtail cable: KSR195, Plenum rated
 4. Environmental:
 - a) Application: Indoor
 - b) Operating Temperature: 4° C to +60° C (40° F to +140° F)
 - c) Relative Humidity: Up to 100%
 5. Regulatory Compliance / Certifications: ROHS 2002 / 95 / EC
- B. Directional Coverage Antennas: Directional coverage antennas shall feature a multi-band design, accommodating multiple frequency bands in a single small antenna.
1. Electrical Band 1:
 - a) Frequency Band: 698 – 800 MHz
 - b) VSWR: $\leq 1.8:1$
 - c) Gain: ≥ 5.0 dBi @ 698 – 800 MHz
 - d) Maximum input power: 50W
 - e) Impedance : 50 Ω
 - f) Beamwidth, Horizontal: 110° nominal
 - g) Polarization: Vertical
 - h) Return Loss: ≤ 10.9 dB
 2. Electrical Band 2:
 - a) Frequency Band: 1710 – 2700 MHz and 800 – 960 MHz
 - b) VSWR: $\leq 1.5:1$
 - c) Gain: ≥ 5.0 dBi @ 800 – 960 MHz and ≥ 6.0 dBi @ 2170 – 2700 MHz and ≥ 8.0 dBi @ 1710 – 2170 MHz
 - d) Maximum input power
 - e) Impedance: 50 Ω

- f) Beamwidth, Horizontal: 90° nominal
 - g) Return Loss: ≤ 10.9 dB
3. Mechanical:
 - a) Connector: 50 Ω N Type Female
 - b) Mounting: 4-hole wall mounting plate
 - c) Radome material: ABS, UV resistant
 - d) Pigtail cable: RG5R, plenum rated
 4. Environmental:
 - a) Application: Indoor
 - b) Operating Temperature: 4° C to +60° C (40° F to +140° F)
 - c) Relative Humidity: Up to 100%
 5. Regulatory Compliance / Certifications: RoHS 2002 / 95 / EC

PART 3 EXECUTION:

3.1 GENERAL:

- A. Quantities of system elements shown on the drawings are illustrative only and are meant to indicate the general configuration of the work. The Contractor is responsible for providing the correct quantities of materials to construct a system that meets the intent of these Specifications and the relevant codes.
- B. Follow all manufacturers' instructions.
- C. Coordinate with all other trades prior to pre-construction submittals and installation.
- D. Public Safety In-Building Wireless System shall be integrated into the fire alarm panel, per AHJ requirements and Manufacturer's recommendations, and shall be monitored remotely.

3.2 EXAMINATION AND PREPARATION:

- A. Prior to the start of this Section's installation work, examine Communications Rooms and Pathways for completeness, compatibility with the work of this Section.

3.3 INSTALLATION:

- A. The Contractor shall assign a single-point-of-contact "Project Manager (PM)" to this project with overall responsibility for communications and ultimate delivery of contracted materials, installation, performance criteria, and services. This PM shall be responsible for presenting the design iterations, cable routes, equipment locations, on-site construction, and coordinate bringing wireless operators into the facility, as well as interfacing with the General Contractor, Engineer, Project Technology Designer (RCDD), School District of Osceola County Project Manager, and School District of Osceola County Technology Services Department Representative, and their own subcontractors.
- B. The Contractor shall use the criteria and requirements of this Section to complete the detailed design of the system. Design shall include computer RF modeling and site surveys. The detailed design shall deliver the pre-construction submittals, including iterations for the Project Technology Designer (RCDD), School District of Osceola County Project Manager, and School District of Osceola County Technology Services Department Representative for review and acceptance. The Contractor shall show design RF signals levels at sub-room precision for all rooms within the defined coverage areas. The Contractor shall obtain compatible drawings from the architect and if said drawings are within the BIM, it shall be the responsibility of the Contractor to modify said BIM model for use in their wireless modeling with shall include the creation of 2-D floor plans, Reflected Ceiling Plans, and elevations.
- C. The Contractor shall coordinate the installation schedule with the General Contractor, Engineer, Project Technology Designer (RCDD), School District of Osceola County Project Manager, and School District of Osceola County Technology Services Department Representative and upon acceptance shall proceed with the installation.
- D. The Contractor shall balance the system components (e.g., antenna) signal strength to the device signal levels.

- E. The Contractor shall perform an active wireless survey demonstrating performance according to the design criteria submitted. This survey shall produce an active report, including floor plans.

3.4 CONNECTIONS TO SYSTEM:

- A. The Contractor shall represent the General Contractor, Engineer, Project Technology Designer (RCDD), School District of Osceola County Project Manager, and School District of Osceola County Technology Services Department Representative during negotiations with wireless operators, coordinate site preparation, assist with wireless service providers' installation, and coordinate connection of wireless service providers to the system. The Wireless Operator integration shall be turn-key. Integration shall include BDA(s), donor antennae, and updated telecommunication drawings.
- B. The Contractor shall represent the School District of Osceola County to obtain required licensing for operations under FCC Regulations.

3.5 LABELING:

- A. All labels shall be permanent, machine generated labels produced by a labeling machine. Labels shall be a permanent polyester material clear in color with label lettering black in color. No handwritten labels will be accepted.
- B. Labeling information will be reviewed at pre-installation meeting, and the Project Technology Designer (Project Electrical Engineer and Registered Communications Distribution Designer (RCDD)) and SDOC Technology Services Department Representative shall approve the labeling scheme prior to the installation of any cabling.
- C. Surfaces shall be cleaned before attaching labels. All labels shall be attached firmly and vertically plumb on equipment.
- D. All labeling of cables, equipment, and components shall be included in as-built documentation, floor plan drawings, and schematic designs.

3.6 SYSTEM ACCEPTANCE TESTING:

- A. Complete the acceptance testing as prescribed in the accepted Testing Procedures Submittal.
- B. Provide test results for Public Safety in the format approved by the AHJ. Coordinate and conduct acceptance testing with the AHJ.
- C. The Contractor shall perform signal strength testing throughout the building(s). Testing shall be performed using a portable spectrum analyzer or other approved test equipment, and the field strength measurements recorded. Test results shall be compared to the requirements of the Performance Specification to determine compliance with this Specification.
- D. Dual testing shall consist of the following:
 - 1. Benchmark Test:
 - a) A signal of known strength shall be injected at the head end. Measurements shall be taken throughout the entire installation area using a portable spectrum analyzer or other approved test equipment and recorded
 - 2. Actual Field Strength Measurements:
 - a) Measurements shall be taken throughout the entire installation area at each of the frequencies re-radiated over the In-Building Wireless System and recorded
 - 3. Test results shall be compiled and submitted to provide evidence of compliance with this Performance Specification.
- E. Upon approval of the test report by Project Technology Designer (Project Electrical Engineer and Registered Communications Distribution Designer (RCDD)) and SDOC Technology Services Department Representative, including functionality, features, ongoing maintenance, and warranty procedures. Demonstrate to the Project Technology Designer (Project Electrical Engineer and Registered Communications Distribution Designer (RCDD)) and SDOC Technology Services Department Representative system operation, including signal strength at select locations.

3.7 FINAL INSPECTION AND CERTIFICATION:

- A. Comply with system acceptance and certification requirements of Division 01 and Division 27.

3.8 SYSTEM TRAINING:

- A. Comply with training requirements within Division 27 00 00 – Communications
- B. Comply with training requirements within other related Division 27 Sections
- C. Contractor shall provide six (6) training sessions of six (6) hour duration each.

END OF SECTION 27 53 23

[REMAINDER OF PAGE INTENTIONALLY LEFT BLANK]

SECURITY SYSTEMS

PART 1 GENERAL

INTRODUCTION

Electronic safety and security systems are crucial in the protection of life and property at any school campus or ancillary facility. This section is developed to ensure all safety and security systems are installed to provide maximum coverage and peak operability. With the convergence of information technology and traditional building systems, it is imperative that these systems integrate seamlessly with the School District of Osceola County's (SDOC) data network, structured cabling and telecommunications spaces to function properly and reliably. Therefore, electronic safety and security system device symbols and details for access control, video surveillance and intrusion detection shall be shown on the technology drawings (T-sheets) and the following requirements shall be followed in addition to relevant Division 28 specifications.

ACCESS CONTROL (Section 28 10 00)

CONTRACTOR'S QUALIFICATIONS

The Contractor(s) must hold a Certified Electrical Contractor (EC), Certified Alarm Contractor I (EF), or Certified Alarm Contractor II (EG) license as issued by the State of Florida Construction Industry Licensing Board according to Florida State Statutes, Chapter 489.

The Access Control Detection Contractor must have successfully completed within the past three (3) years a minimum of ten (10) commercial Intrusion Detection jobs where the contract amount was \$5,000.00 or more.

Must be a factory certified dealer of DORMAKABA Aurora and Keyscan product lines with full warranty privileges.

All technicians dispatched to troubleshoot or program access control panels must be factory certified with DORMAKABA.

INSTALLATION

Standard Requirements for installation of complete Access Control system including servers, locks, strikes, card readers, and associated hardware:

Access Control shall be installed at the following locations:

Campus primary entrance exterior doors (main entrance, administration lobby, staff entrance, and kitchen entrance)

All doors exiting the secure lobby

Critical kitchen area doors (dry storage and manager's office)

All access control network cabling shall terminate to dedicated security patch panels in the local CD (MDF) / FD (IDF) location. Patch panel installation location in racks to be coordinated with SDOC Technology Services Department Network Communications Analyst (Kevin McKenzie) or designee.

The structured cabling contractor shall be responsible for all network structured cabling including patch panels, pathways, supports, terminations, and associated hardware to support installation of access control system.

Security Contractor shall be responsible for all access control hardware installation to manufacturer's specifications.

Security contractor shall be responsible for all low voltage cabling between controllers and devices.

Security contractor shall provide all certified category 6 patch cords, orange in color, required at each end.

All cabling shall be labeled at both ends to indicate device number, patch panel number and port number. All labels shall be printed in accordance with UL 969, not handwritten.

All cabling work must be completed in accordance with, but not limited to:

The National Electrical Code - Latest Edition

BICSI Telecommunications Distribution Methods Manual Latest Edition

BICSI Information Technology Systems Installation Methods Manual Latest Edition

School District of Osceola County - Division 27 Standards and Specifications.

The School District of Osceola County shall be responsible to provide DORMAKABA Aurora server, server configuration, network switches, server cabinet, UPS, switch port configuration, user credentials, user configuration, and schedule configuration.

Security Contractor shall provide and install all other equipment and perform all other system configuration as required for a complete and operational access control system.

END OF SECTION 28 10 00

VIDEO SURVEILLANCE (Section 28 20 00)

CONTRACTOR QUALIFICATIONS:

The Contractor(s) must hold a Certified Electrical Contractor (EC), Certified Alarm Contractor I (EF), Certified Alarm Contractor II (EG), or Certified Specialty Contractor (ES) license as issued by the State of Florida Construction Industry Licensing Board according to Florida State Statutes, Chapter 489. The licenses must be valid at the time of the Bid opening.

The Video Surveillance Contractor must have successfully completed, within the past three (3) years, a minimum of ten (10) commercial Video Surveillance projects where the contract amount exceeded \$10K.

Must be an authorized dealer of the Salient Systems Corporation with full warranty privileges.

All technicians dispatched to install, troubleshoot or program Completeview VMS Systems must be factory certified with the Salient System Corporation.

INSTALLATION

Standard Requirements for installation of complete Video Surveillance system including servers, mounts, supports, cameras, and associated hardware:

Group or common areas (interior and exterior) shall have adequate video surveillance coverage. EXCEPTIONS: Teacher/staff lounges, classrooms, restrooms, dressing rooms, and locker rooms.

All Video Surveillance network cabling shall terminate to dedicated security patch panels in the local CD (MDF) / FD (IDF) location. Patch panel installation location in racks to be coordinated with SDOC Technology Services Department Network Communications Analyst (Kevin McKenzie) or designee.

The structured cabling contractor shall be responsible for all network structured cabling including patch panels, pathways, supports, terminations, and associated hardware to support installation of Video Surveillance system.

Security Contractor shall be responsible for all camera installation to manufacturer's specifications.

Security contractor shall provide all certified category 6 patch cords, orange in color, required at each end.

All cabling shall be labeled at both ends to indicate camera location, patch panel number and port number. All labels shall be printed in accordance with UL 969, not handwritten.

All structured cabling work must be completed in accordance with, but not limited to:

The National Electrical Code, Latest Edition

BICSI Telecommunications Distribution Methods Manual Latest Edition

BICSI Information Technology Systems Installation Methods Manual Latest Edition

School District of Osceola County - Division 27 Standards and Specifications.

The School District of Osceola County shall be responsible to provide Salient NVR servers, server configuration, network switches, server cabinet, UPS, switch port configuration, user configuration, camera configuration, camera ceiling tile mount (24"x24"), HTH-273ZJ-130B-TRL box arm, Hikvision cameras, and Salient camera licenses.

All cameras shall be labeled for identification for specific physical location and numeric identification. Example: If camera #32 is located in building two (2), second floor corridor, this camera will be programmed internally and viewed in the system as C32 - BLDG2 / FL 2 Corridor.

After the installation is deemed substantially complete, a final pass for focus, positioning and view of all cameras shall be coordinated with the Safety, Security, and Emergency Management (SSEM) Coordinator (Russell Gould) or designee.

END OF SECTION 28 20 00

INTRUSION DETECTION (Section 28 30 00)

CONTRACTOR'S QUALIFICATIONS:

The Contractor(s) must hold a Certified Electrical Contractor (EC), Certified Alarm Contractor I (EF), Certified Alarm Contractor II (EG), or Certified Specialty Contractor (ES) license as issued by the State of Florida Construction Industry Licensing Board according to Florida State Statutes, Chapter 489.

The Intrusion Detection Contractor must have successfully completed within the past three (3) years a minimum of ten (10) commercial Intrusion Detection jobs where the contract amount exceeded \$5K.

Must be an authorized dealer of Digital Monitoring Products (DMP) with full warranty privileges.

All technicians dispatched to troubleshoot or program intrusion panels must be factory certified with DMP.

INSTALLATION

Standard Requirements for installation of complete Intrusion Detection (alarm) system including control panels, sensors, keypads, and associated hardware:

All administrative, corridor, computer lab, band/music, media center, and high-density technology spaces shall have adequate motion activated Intrusion Detection coverage.

Keypads shall be located at each building primary entrance, staff parking entrance, and kitchen entrance.

The system siren/strobe shall be located at the campus administrative entrance on the exterior of the building.

All Intrusion Detection (alarm) network cabling shall terminate to dedicated security patch panels in the local CD (MDF) / FD (IDF) location. Patch panel installation location in racks to be coordinated with SDOC Technology Services Department Network Communications Analyst (Kevin McKenzie) or designee.

The structured cabling Contractor shall be responsible for all network structured cabling including patch panels, pathways, supports, terminations, and associated hardware to support installation of Intrusion Detection system.

Security Contractor shall be responsible for all Intrusion Detection (alarm) device installation to manufacturer's specifications

Security Contractor shall be responsible for all low voltage cabling between main control panel, expansion panels and devices.

Security Contractor shall provide all certified category 6 patch cords, orange in color, required at each end.

All cabling shall be labeled at both ends to indicate device number, expansion panel number and expansion panel port number. All labels shall be printed in accordance with UL 969, not handwritten.

All structured cabling work must be completed in accordance with, but not limited to: The National Electrical Code, BICSI Telecommunications Distribution Methods Manual 14th Edition, BICSI Information Technology Systems Installation Methods Manual 7th Edition, School District of Osceola County - Division 27 Standards and Specifications.

The School District of Osceola County shall be responsible to provide user and schedule configuration, network switches, and switch port configuration.

Security Contractor shall provide and install all other equipment and perform all other system configuration as required for a complete and operational Digital Monitoring Products (DMP) Intrusion Detection (alarm) system.

END OF SECTION 28 30 00

[REMAINDER OF PAGE INTENTIONALLY LEFT BLANK]



School District of Osceola
County

PRE – APPROVED PRODUCTS LIST

Technology Services Department



Kevin McKenzie – RCDD / Kenny Shocklee – TIS
Revised November 01, 2021

Pre-Approved Product List

1.1 Structured Premise Cabling:

- A. Hubbell
 - 1. Category 6A – Yellow
 - a) C6ASRDSY – Riser Rated cable
 - b) C6ASPSY – Plenum Rated cable

1.2 Fiber Optic Cabling:

- A. Corning
 - 1. Single Mode – OS2 – Indoor / Outdoor Loose Tube
 - a) 012EUF-T4101D20 – FREEDM – Non-Plenum Rated cable – 12 strand
 - b) 012ESP-T4101D20 – FREEDM – Plenum Rated cable – 12 strand
 - c) 024EUF-T4101D20 – FREEDM – Non-Plenum Rated cable – 24 strand
 - d) 024EWP-T4101D20 – FREEDM – Plenum Rated cable – 24 strand
 - e) 048EUF-T4101D20 – FREEDM – Non-Plenum Rated cable – 48 strand
 - f) 048EWP-T4101D20 – FREEDM – Plenum Rated cable – 48 strand
 - 2. Single Mode – OS2 – Outdoor Loose Tube
 - a) 024ZU4-T4F22D20 – ALTOS – Non-Armor cable – 24 strand
 - b) 024ZUC-T4F22D20 – ALTOS – Single Armor cable – 24 strand
 - c) 024EUD-T4101D20 – ALTOS – Double Armor cable – 24 strand
 - d) 048ZU4-T4F22D20 – ALTOS – Non-Armor cable – 48 strand
 - e) 048ZUC-T4F22D20 – ALTOS – Single Armor cable – 48 strand
 - f) 048EUD-T4101D20 – ALTOS – Double Armor cable – 48 strand
 - 3. Multi-Mode – OM3
 - a) 006TUF-T4180D20 – FREEDM – Non-Plenum Rated cable – 6 strand
 - b) 006TSP-T4180D20 – FREEDM – Plenum Rated cable – 6 strand
 - c) 012TUF-T4180D20 – FREEDM – Non-Plenum Rated cable – 12 strand
 - d) 012TSP-T4180D20 – FREEDM – Plenum Rated cable – 12 strand
 - e) 024TUF-T4180D20 – FREEDM – Non-Plenum Rated cable – 24 strand
 - f) 024TSP-T4180D20 – FREEDM – Plenum Rated cable – 24 strand
- B. Hubbell
 - 1. Single Mode – OS2 – Indoor / Outdoor Loose Tube
 - a) HFCH2012RBKS – Non-Plenum Rated cable – 12 strand
 - b) HFCH2012PBKS – Plenum Rated cable – 12 strand
 - c) HFCH2024RBKS – Non-Plenum Rated cable – 24 strand
 - d) HFCH2024PBKS – Plenum Rated cable – 24 strand
 - e) HFCH2048RBKS – Non-Plenum Rated cable – 48 strand
 - f) HFCH2048PBKS – Plenum Rated cable – 48 strand
 - 2. Single Mode – OS2 – Outdoor Loose Tube

- a) HFCH3024BKS – Non-Armor cable – 24 strand
 - b) HFCH4024BKS – Armor cable – 24 strand
 - c) HFCH5024BKS – Double Armor cable – 24 strand
 - d) HFCH3048BKS – Non-Armor cable – 48 strand
 - e) HFCH4048BKS – Armor cable – 48 strand
 - f) HFCH5048BKS – Double Armor cable – 48 strand
3. Multi-Mode – OM3
- a) HFCH2006RBK3 – Non-Plenum Rated cable – 6 strand
 - b) HFCH2006PBK3 – Plenum Rated cable – 6 strand
 - c) HFCH2012RBK3 – Non-Plenum Rated cable 12 strand
 - d) HFCH2012PBK3 – Plenum Rated cable – 12 strand
 - e) HFCH2024RBK3 – Non-Plenum Rated cable – 24 strand
 - f) HFCH2024PBK3 – Plenum Rated cable – 24 strand

1.3 Anchors:

A. Concrete

1. Red Head Concrete Anchoring System

- a) Expansion Anchors
- b) Dynabolt Sleeve
- c) Trubolt
- d) Screw Anchors
- e) Tapcon
- f) Tapcon Maxi-set
- g) Tapcon Scots
- h) Tapcon XL Screw
- i) Tapcon SG ancors

2. Drywall

- a) Toggler Anchoring System
- b) Snaptoggle
- c) Heavy duty hollow-wall anchors
- d) SnapSkru

1.4 Back Boards:

A. Ready Spec

1. Single Panel Kits

- a) RB-A4848NPW (48" x 48")

2. Modular Wall Kits

- a) RB-AD4896W (4' x 8')

1.5 Cable Supports:

A. Strap

- 1. Erico

- a) Caddy
 - 1) CAT12 – 181100
 - 2) CAT21 – 181110
 - 3) CAT32 – 181120
 - 4) CAT425 – 181130
- B. Wire Basket Tray
 - 1. Hubbell
 - a) HBT0204BK – 2” x 4” x 118” overhead tray – Black
 - b) HBT0212BK – 2” x 12” x 118” overhead tray – Black
 - c) HBT0622BK – 6” x 22” x 118” overhead tray – Black

1.6 Cable Trays:

- A. Hubbell
 - 1. 4” x 24” x 118”
 - a) HPWW0424

1.7 Cable Wraps:

- A. Hook and loop fasteners
 - 1. Velcro
 - a) White
 - b) Black

1.8 Charging Station:

- A. JAR Systems
 - 1. CS-1610 Charging Station
 - 2. ADAPT4-ACTIV Charging Station

1.9 Classroom Amplification:

- A. Audio Enhancement – Sole Source

1.10 Clocks:

- A. Rauland Borg
 - 1. 16 inch synchronized analog clock
 - a) TCCKAN16
 - 2. Atomic to Master clock synchronizer module
 - a) TCAMCS
 - 3. Master Clock
 - a) 2524

1.11 Data Hardware / Components / Devices:

- A. Hubbell
 - 1. Audio Visual Component
 - a) 4K / USB Extender (pair) – new construction
 - 1) ISFHD4BK
 - b) 4K / VGA / HDMI / USB Extender (three) – Renovation
 - 1) ISFHDT421KB

2. Power Component
 - a) 125V 20A power receptacle with 5vdc pigtail (USB 2.0)
 - 1) AVPS20BK
 - 2) AVPS20W
3. Data Component
 - a) Patch Panel
 - 1) 1U Keystone unloaded
 - a. HPJ24
 - 2) 2U Keystone unloaded
 - a. HPJ48
4. Copper Jack
 - a) Nextspeed CAT 6A
 - 1) HJU6AOW
 - 2) HJU6ABK
 - 3) HJ6Axx
 - b) Nextspeed CAT 6
 - 1) HXJ6OW
 - 2) HXJ6BK
 - 3) HJ6xx
 - 4) HJU6xx
5. Faceplates
 - a) Multimedia Face Plates
 - 1) NSP11LA – Single gang, single port
 - 2) NSP12LA – Single gang, dual port
 - 3) NSP14LA – single gang, four port
 - b) IFP Face Plates w/label fields
 - 1) IFP110W – Single gang, single port
 - 2) IFP120W – Single gang, dual port
 - 3) IFP140W – Single gang, four port
 - 4) IFP260W – double gang, six port
 - c) iStation multi-service face plates
 - 1) NP260W – Single gang, decorator wall plate
 - 2) NP2620W – double gang, decorator wall plate
 - 3) NP2630W – triple gang, decorator wall plate
 - 4) NP2640W – four gang, decorator wall plate
6. Blanks
 - a) IMB050W – 0.5-unit blank module
 - b) IMB10W – 1-unit blank module
 - c) IMB150W – 1.5-unit blank module

- d) SFB10 – single blank unit
- 7. Boxes
 - a) Wall Boxes / enclosures
 - 1) HBL989 – double gang
 - 2) HBL986 – triple gang
 - 3) NSAV62M – double gang in wall enclosure
 - 4) NSAV124M – four gang in wall enclosure
 - b) Ceiling AV enclosure
 - 1) AVCE1 – Non-plenum – white ceiling mount
 - 2) AVCE1P – Plenum – white ceiling mount
 - c) Recessed Floor Boxes
 - 1) CFB2G30 – double gang rectangular – standard
 - 2) CFB2G30CR – double gang rectangular – on-grade
 - 3) CFB4G30 – four gang rectangular – standard
 - 4) CFB4G30CR – four gang rectangular – on-grade
 - 5) CFB6G30 – six gang rectangular – standard
 - 6) CFB6G30cR – six gang rectangular – on-grade
 - d) Covers
 - 1) 24GCCVRBK – Surface Rectangular cover for two / four gang floor boxes
 - 2) 24GCCVRBKC – Surface rectangular cover for two / four gang floor boxes with inserts
 - 3) 24GTCVRBK – Flush rectangular cover for two / four gang floor boxes
 - 4) 24GTCVRBKC – Flush rectangular cover for two / four gang floor boxes with inserts
 - 5) 610GCCVRBK – Surface rectangular cover for six / ten gang floor boxes
 - 6) 610GCCVRBKC – Surface rectangular cover for six / ten gang floor boxes with inserts
 - 7) 610GTCVRBK – Flush rectangular cover for six / ten gang floor boxes
 - 8) 610GTCVRBKC – Flush rectangular cover for six / ten gang floor boxes with inserts
- 8. Inserts
 - a) FBMPREC – Decorator plate
 - b) FBMP6KS – ISF6 keystone jack plate
 - c) FB10MPREC – Decorator plate (6 / 10 gang)
 - d) FB10MPKEY – Decorator plate (including ISF6GY insert)
- 9. Brackets
 - a) CP-2 – grid hanger bracket (for WAP).

1.12 Enclosures:

- A. Server
 - 1. APC
 - a) NetShelter SX 42U (1) AR3100
- B. Free Standing
 - 1. Chatsworth

- a) Mega-Frame Series
 - 1) M1040-722
- C. Wall Mount
 - 1. Tripp-Lite
 - a) Smart Rack
 - 1) SRW18UHD

1.13 Fiber Optic Connectors / Appliances:

- A. Fiber LIU
 - 1. Corning
 - a) CCH-01U – Closet Connector Housing – 1 RMU 2 cassettes / modules panels
 - b) CCH-02U – Closet Connector Housing – 2 RMU 4 cassettes / modules panels
 - c) CCH-03U – Closet Connector Housing – 3 RMU 6 cassettes / modules panels
 - d) CCH-04U – Closet Connector Housing – 4 RMU 12 cassettes / modules panels
 - e) PWH-12P – Pretium Wall-Mountable Housing – 12 CCH connector panels
 - 2. Hubbell
 - a) FCR1U3SP – FCR Series, 1 RMU 3 Adapter Packs
 - b) FCR2U6SP – FCR Series, 2 RMU 6 Adapter Packs
 - c) FCR3U12SP – FCR Series, 3 RMU 12 Adapter Packs
 - d) FCR4U15SP – FCR Series, 4 RMU 15 Adapter Packs
 - e) FCW12SP – wall mount, 12 adapter panel, 4 splice tray capacity
- B. Fiber Adapters
 - 1. Corning
 - a) CCH-CP12-E4 – Closet Connector Housing panel – 12 port LC Duplex 50µm multi-mode OM3 / OM4
 - b) CCH-CP12-E7 – Closet Connector Housing panel – 12 port SC Duplex 50µm multi-mode OM3 / OM4
 - c) CCH-CP12-xx – Closet Connector Housing panel – 12 port SC Duplex blank
 - d) WLL-KS-E4 – Wall-Plate Outlet Keystone adapter aqua LC non-keyed to non-keyed
 - e) ADPO-DLCO-CCARF-CLS – Secure LC adapter aqua non-keyed to non-keyed (OM1, 2, 3, 4 / OS2 reduced-flange mount, ceramic sleeve)
 - f) WLL-KS-E6 – Wall-Plate Outlet Keystone adapter aqua SC non-keyed to non-keyed
 - 2. Hubbell
 - a) FSPKLCDS6AQ – 12 port, loaded, LC (Aqua)
 - b) FSPSCDS6AQ – 12 port, loaded, SC (Aqua)
 - c) FSPSC12BK – 12 port, Unloaded (Black)
 - d) SFFLCSAQBK – LC Duplex Flush Mount Keystone (25 pack, Aqua / Black)
 - e) SFLCSAQBK – LC Duplex Keystone (25 pack, Aqua / Black)
 - f) SFFSCSAQBK – SC Simplex Flush Mount Keystone (25 pack, Aqua / Black)
 - g) SFFSCSRBK – SC Simplex Flush Mount Keystone (25 pack, RED / Black (Fire Alarm ONLY))
 - h) SFFSCSBEBK – SC Simplex Flush Mount Keystone (25 pack, BEIGE / Black (HVAC ONLY))
 - i) SFSCSAQBK – SC Simplex Keystone (25 pack, Aqua / Black)

- j) SFSCSRBK – SC Simplex Keystone (25 pack, RED / Black (Fire Alarm ONLY))
 - k) SFSCSBEBK – SC Simplex Keystone (25 pack, BEIGE / Black (HVAC ONLY))
 - l) FCLCF900SM6PK – LC single mode OS2 Fusion Splice-on connector (6 pack)
 - m) FCSCF900SM6PK – SC single mode OS2 Fusion Splice-on connector (6 pack)
 - n) FCSCF900SMA6PK – SC single mode OS2 Fusion Splice-on connector (6 pack)
 - o) FCLCF900M50G6PK – LC Multi-mode OM3 Fusion Splice-on connector (6 pack)
 - p) FCSCF900M50G6PK – SC Multi-mode OM3 Fusion Splice-on connector (6 pack)
 - q) Keystone adapter
 - 1) SFLCSAQBK – LC Single / Multi-mode duplex keystone adapter
 - 2) SFSCSAQBK – SC Single / Multi-mode simplex keystone adapter
- C. Fiber Cassettes:
- 1. Corning
 - a) CCH-CS12-E4-P00TE – Closet Connector Housing pigtail cassette, loaded with CCH panel and factory-terminated pigtails, 12 strand, LC Simplex, OM3 – single fiber splicing
 - b) CCH-CS12-E6-P00TE – Closet Connector Housing pigtail cassette, loaded with CCH panel and factory-terminated pigtails, 12 strand, SC simplex, OM3 – single fiber splicing
 - c) CCH-CS12-A9-P00RE – Closet Connector Housing pigtail cassette, loaded with CCH panel and factory-terminated pigtails, 12 strand, LC Duplex, SM/UPC – single fiber splicing
 - d) CCH-CS12-3C-P00RE – Closet Connector Housing pigtail cassette, loaded with CCH panel and factory-terminated pigtails, 12 strand, SC simplex, SM/UPC – single fiber splicing
 - 2. Hubbell
 - a) OCSPLCD12S2 – Fusion Spliced LC cassette 12 strand capacity
 - b) OCSPSCD12S2 – Fusion Spliced SC cassette 12 strand capacity
- D. Fiber Splice Enclosure:
- 1. Corning
 - a) CSH-03U – Closet Splice Housing – 3 RMU – holds 12 0.2in splice trays
 - b) M67-076 – Splice trays, heat-shrink Fusion Splices, 0.2in 12 strand
 - c) M67-112 – Splice trays, heat-shrink Fusion Splices, 0.2 in 24 strand
 - 2. Hubbell
 - a) FCR350SE – FCR Series, 2 RMU 6 tray capacity
 - b) STRAY12F – 12 strand Fusion Splice tray
 - c) STRAY24F – 24 strand Fusion Splice tray
- E. Fiber Optic Connectors:
- 1. Corning
 - a) FuseLite
 - 1) SOC-LCU-900-SM – FuseLite LC single mode OS2 Tight Buffered Fusion Splice connector
 - 2) SOC-SCU-900SM – FuseLite SC single mode OS2 Tight Buffered Fusion Splice connector
 - 3) SOC-SCA-900SM – FuseLite SC single mode OS2 Tight Buffered Fusion Splice connector
 - 4) SOC-LC-900-OM4 – FuseLite LC 50 µm multi-mode OM2/3/4 Tight Buffered Fusion Splice connector
 - 5) SOC-SC-900-OM4 – FuseLite SC 50 µm multi-mode OM2/3/4 Tight Buffered Fusion Splice

connector

2. Hubbell
 - a) OptiChannel
 - 1) FCLCF900SM6PK – LC single mode OS2 Fusion Splice-on connector (6 pack)
 - 2) FCSCF900SM6PK – SC single mode OS2 Fusion Splice-on connector (6 pack)
 - 3) FCSCF900SMA6PK – SC single mode OS2 Fusion Splice-on connector (6 pack)
 - 4) FCLCF900M506PK – LC Multi-mode OM2 Fusion Splice-on connector (6 pack)
 - 5) FCSCF900M605PK – SC Multi-mode OM2 Fusion Splice-on connector (6 pack)
 - 6) FCLCF900M50G6PK – LC Multi-mode OM3 Fusion Splice-on connector (6 pack)
 - 7) FCSCF900M50G6PK – SC Multi-mode OM3 Fusion Splice-on connector (6 pack)

1.14 Fire Rated Appliances:

- A. EZ Path
 1. EZDP144RS2 – Split wall – Full Kit (existing cabling)
 2. EZDP44S2 – Single Pathway – Full Kit

1.15 Free Standing Racks:

- A. Chatsworth
 1. 55053-703 – Black – two post
 2. 10600-019 – Rack Base Insulator Kit
 3. 10250-712 – Universal Runway
 4. 11421-712 – Angle support Kit
 5. 10595-712 – Rack to Runway Plate Kit
 6. 10642-001 – End Caps (pair)
- B. Hubbell
 1. HPW84RR19 – Black – two post
 2. HRRP – Insulation Kit
 3. HLRP – Foot kit
 4. HLJB – j-volt kit
 5. HLWRK – Nextframe ladder rack, wall / rack mounting kit
 6. HLECPK2 – End Caps (pair)
 7. HLS1012B – 12” Ladder rack 10 foot section black
 8. HLBSK – Butt splice kit
 9. HLTK – T junction splice kit
 10. TLTSB12B – Triangle wall support
 11. TLX0612 Wall angle support
 12. HLVWBK – Vertical wall bracket
 13. HLEK23 – Elevation kit 2-3”
 14. HLEK46 – Elevation kit 4-6”

1.16 Ground Bus Bar:

- A. Hubbell

1. HBBB14416H – 4 inch x 16 inch copper bus bar
2. HGRKTD9D – 9 inch ladder bonding strap
3. HGBTEBCBRKL10 – ladder bonding bracket (10 pack)
4. HBBB14212 – 12 inch wall mount bonding bus bar with isolators
5. HBBHR19KT – Horizontal rack mount bonding bar – 19 inch
6. HBBBVR36KT – Vertical rack mount bonding bar – 36 inch
7. HGVVL06D - #6 AWG double hole compression lug

1.17 Grounding Lugs:

A. Hubbell

- | | | |
|-------------------|-----------|--------|
| 1. HGBL06D (SBB) | # 6 AWG | Blue |
| 2. HGBL06DA (PBB) | # 6 AWG | Blue |
| 3. HGBL04DA | #4 AWG | Gray |
| 4. HGBL02DA | #2 AWG | Brown |
| 5. HGBL01DA | #1 AWG | Green |
| 6. HGBL10DA | 1/0 | Pink |
| 7. HGBL20DA | 2/0 | Black |
| 8. HGBL30DA | 3/0 | Orange |
| 9. HGBL40DB | 4/0 | Purple |
| 10. HGBL250DB | 250 kcmil | Yellow |
| 11. HGBL300DB | 300 kcmil | White |
| 12. HGBL350DB | 350 kcmil | Red |
| 13. HGBL500DB | 500 kcmil | Brown |
| 14. HGBL600DB | 600 kcmil | Green |
| 15. HGBL750DB | 750 kcmil | Black |

1.18 Innerduct:

A. MaxCell

1. MXED86383 – Fabric Edge detectable 3 cell innerduct

1.19 Interactive Flat Panels:

A. SMART

1. MX275 – Interactive Flat Monitor

1.20 Intercom:

A. Rauland Borg – Sole Source

1.21 Monitor:

A. LG

1. LJ5100 Series – LED 1080p flat monitor

B. Vizio

1. D40F-E1 – 40 inch LED Smart HDTV
2. D43-D2 – 43 inch LED flat monitor
3. D55-D2 – 55 inch LED flat monitor

4. D65-D2 – 65 inch LED flat monitor

1.22 Mounts – Visual:

A. Balance Box

1. 480A02 – BB400-70 – rated capacity 83.6 - 142.2 lbs. (38-66 kg) - typical MX275
2. 481A21 – VESA interface
3. 480A04 – BB400-90 – rated capacity 145.2 - 198.0 lbs. (66-90 kg) typical SMART 6065
4. 481A21 – VESA interface
5. 480A08 – BB650-130 – rated capacity 137.3 - 269.3 lbs. (62-122 kg) typical SMART 7075
6. 481A19 – VESA interface

B. Chief Manufacturing

1. LSM-LTM series – 70 inch application – rated capacity 200 lbs. Typical SMART 6065 / MX275
2. WBM2U series – 50 inch application – rated capacity 125 lbs. Typical flat monitors over markerboard applications
3. WBM4E series – 70 inch application – rated capacity 300 lbs. Typical interactive flat panel over markerboard applications
4. VCMU – Heavy duty universal projector mount

C. Copernicus

1. IFP500 – iRover2 Interactive cart – rated capacity 200 lbs. Typical MX275

D. Peerless

1. SF680 series – 65-70 inch application – rated capacity 350 lbs. Typical interactive flat panel
2. Premier IWB600-2SB – 77 inch application – rated capacity 70.5 lbs. Typical SMART Board 680 over markerboard applications
3. P5080T – 50-80 inch application – rated capacity 300 lbs. Typical interactive flat panel

E.

1.23 Mounts – Access Points:

A. TerraWave

1. TW-HWM-C-CVR-521473 – horizontal wall mount – Wi-Fi enclosure with cover
2. V-HWM-12124-W – horizontal wall mount – Wi-Fi enclosure with bubble cover

1.24 Patch/Equipment Cords:

A. Corning

1. Single Mode
 - a) 727200G5120001M – SC Duplex to SC Duplex – Yellow – 1 meter
 - b) 727200G5120003M – SC Duplex to SC Duplex – Yellow – 3 meter
 - c) 727200G5120005M – SC Duplex to SC Duplex – Yellow – 5 meter
 - d) 040402G5120001M – LC Duplex to LC Duplex – Yellow – 1 meter
 - e) 040402G5120003M – LC Duplex to LC Duplex – Yellow – 3 meter
 - f) 040402G5120005M – LC Duplex to LC Duplex – Yellow – 5 meter
 - g) 047202G5120001M – SC Duplex to LC Duplex – Yellow – 1 meter
 - h) 047202G5120003M – SC Duplex to LC Duplex – Yellow – 1 meter
 - i) 047202G5120005M – SC Duplex to LC Duplex – Yellow – 1 meter

2. Multi-Mode

- a) 575702T5120001M – SC Duplex to SC Duplex – Aqua – 1 meter
- b) 575702T5120003M – SC Duplex to SC Duplex – Aqua – 3 meter
- c) 575702T5120005M – SC Duplex to SC Duplex – Aqua – 5 meter
- d) 050502T5120001M – LC Duplex to LC Duplex – Aqua – 1 meter
- e) 050502T5120003M – LC Duplex to LC Duplex – Aqua – 3 meter
- f) 050502T5120005M – LC Duplex to LC Duplex – Aqua – 5 meter
- g) 055702T5120001M – SC Duplex to LC Duplex – Aqua – 1 meter
- h) 055702T5120003M – SC Duplex to LC Duplex – Aqua – 3 meter
- i) 055702T5120005M – SC Duplex to LC Duplex – Aqua – 5 meter

B. Hubbell

1. OptiChannel

a) Single Mode

- 1) DFPCSCSCS01SM – SC to SC OS2 – 1 meter (Yellow)
- 2) DFPCSCSCS03SM – SC to SC OS2 – 3 meter (Yellow)
- 3) DFPCSCSCS05SM – SC to SC OS2 – 5 meter (Yellow)
- 4) DFPCLCLCS01SM – LC to LC OS2 – 1 meter (Yellow)
- 5) DFPCLCLCS03SM – LC to LC OS2 – 3 meter (Yellow)
- 6) DFPCLCLCS05SM – LC to LC OS2 – 5 meter (Yellow)
- 7) DFPCLCSCS01SM – LC to SC OS2 – 1 meter (Yellow)
- 8) DFPCLCSCS03SM – LC to SC OS2 – 3 meter (Yellow)
- 9) DFPCLCSCS05SM – LC to SC OS2 – 5 meter (Yellow)

b) Multi-Mode

- 1) DFPCSCSCE01MM – SC to SC OM3 – 1 meter (Aqua)
- 2) DFPCSCSCE03MM – SC to SC OM3 – 3 meter (Aqua)
- 3) DFPCSCSCE05MM – SC to SC OM3 – 5 meter (Aqua)
- 4) DFPCLCLCE01MM – LC to LC OM3 – 1 meter (Aqua)
- 5) DFPCLCLCE03MM – LC to LC OM3 – 3 meter (Aqua)
- 6) DFPCLCLCE05MM – LC to LC OM3 – 5 meter (Aqua)
- 7) DFPCLCSCE01MM – LC to SC OM3 – 1 meter (Aqua)
- 8) DFPCLCSCE03MM – LC to SC OM3 – 3 meter (Aqua)
- 9) DFPCLCSCE05MM – LC to SC OM3 – 5 meter (Aqua)

c) Bundles

1) Single Mode

- a. FPBKR06SC6S – SC, 6 strand – 3 meter
- b. FPBKR12SC6S – SC, 12 strand – 3 meter
- c. FPBKR06LC6S – LC, 6 strand – 3 meter
- d. FPBKR12LC6S – LC, 12 strand – 3 meter

2) Multi-Mode

- a. FPBKR12SC3M – SC, 12 strand – 3 meter
- b. FPBKR12LC3M – LC, 12 strand – 3 meter

2. Nextspeed

a) Category 6 – 3 foot

- 1) HC6Y03 – Standard OD – yellow – 3 foot (Station / Closet – computer / printer)
- 2) HC6BK03 – Standard OD – black – 3 foot (Station / Closet – phone)
- 3) HC6OR03 – Standard OD – orange – 3 foot (Station / Closet – security)
- 4) HC6P03 – Standard OD – purple – 3 foot (Closet – server)
- 5) HC6GN03 – Standard OD – green – 3 foot (Station / Closet – intercom / AV monitor)
- 6) HC6GY03 – Standard OD – gray – 3 foot (Station / Closet – POS / Kronos)
- 7) HC6R03 – Standard OD – red – 3 foot (Closet – Fire Alarm)
- 8) HC6W03 – Standard OD – white – 3 foot (Closet – HVAC / Facility)
- 9) HC6B03 – Standard OD – blue – 3 foot (Closet – UPS)

b) Category 6 – 5 foot

- 1) HC6Y05 – Standard OD – yellow – 5 foot (Station / Closet – computer / printer)
- 2) HC6BK05 – Standard OD – black – 5 foot (Station / Closet – phone)
- 3) HC6OR05 – Standard OD – orange – 5 foot (Station / Closet – security)
- 4) HC6P05 – Standard OD – purple – 5 foot (Closet – server)
- 5) HC6GN05 – Standard OD – green – 5 foot (Station / Closet – intercom / AV monitor)
- 6) HC6GY05 – Standard OD – gray – 5 foot (Station / Closet – POS / Kronos)
- 7) HC6R05 – Standard OD – red – 5 foot (Closet – Fire Alarm)
- 8) HC6W05 – Standard OD – white – 5 foot (Closet – HVAC / Facility)
- 9) HC6B05 – Standard OD – blue – 5 foot (Closet – UPS)

c) Category 6 – 7 foot

- 1) HC6Y07 – Standard OD – yellow – 7 foot (Station / Closet – computer / printer)
- 2) HC6BK07 – Standard OD – black – 7 foot (Station / Closet – phone)
- 3) HC6OR07 – Standard OD – orange – 7 foot (Station / Closet – security)
- 4) HC6P07 – Standard OD – purple – 7 foot (Closet – server)
- 5) HC6GN07 – Standard OD – green – 7 foot (Station / Closet – intercom / AV monitor)
- 6) HC6GY07 – Standard OD – gray – 7 foot (Station / Closet – POS / Kronos)
- 7) HC6R07 – Standard OD – red – 7 foot (Closet – Fire Alarm)
- 8) HC6W07 – Standard OD – white – 7 foot (Closet – HVAC / Facility)
- 9) HC6B07 – Standard OD – blue – 7 foot (Closet – UPS)

d) Category 6 – 10 foot

- 1) HC6Y10 – Standard OD – yellow – 10 foot (Station / Closet – computer / printer)
- 2) HC6BK10 – Standard OD – black – 10 foot (Station / Closet – phone)
- 3) HC6OR10 – Standard OD – orange – 10 foot (Station / Closet – security)
- 4) HC6P10 – Standard OD – purple – 10 foot (Closet – server)
- 5) HC6GN10 – Standard OD – green – 10 foot (Station / Closet – intercom / AV monitor)

- 6) HC6GY10 – Standard OD – gray – 10 foot (Station / Closet – POS / Kronos)
 - 7) HC6R10 – Standard OD – red – 10 foot (Closet – Fire Alarm)
 - 8) HC6W10 – Standard OD – white – 10 foot (Closet – HVAC / Facility)
 - 9) HC6B10 – Standard OD – blue – 10 foot (Closet – UPS)
- e) Category 6 – 15 foot
- 1) HC6Y15 – Standard OD – yellow – 15 foot (Station / Closet – computer / printer)
 - 2) HC6BK15 – Standard OD – black – 15 foot (Station / Closet – phone)
 - 3) HC6OR15 – Standard OD – orange – 15 foot (Station / Closet – security)
 - 4) HC6P15 – Standard OD – purple – 15 foot (Closet – server)
 - 5) HC6GN15 – Standard OD – green – 15 foot (Station / Closet – intercom / AV monitor)
 - 6) HC6GY15 – Standard OD – gray – 15 foot (Station / Closet – POS / Kronos)
 - 7) HC6R15 – Standard OD – red – 15 foot (Closet – Fire Alarm)
 - 8) HC6W15 – Standard OD – white – 15 foot (Closet – HVAC / Facility)
 - 9) HC6B15 – Standard OD – blue – 15 foot (Closet – UPS)
- f) Category 6 – 25 foot
- 1) HC6Y25 – Standard OD – yellow – 25 foot (Station / Closet – computer / printer)
 - 2) HC6BK25 – Standard OD – black – 25 foot (Station / Closet – phone)
 - 3) HC6OR25 – Standard OD – orange – 25 foot (Station / Closet – security)
 - 4) HC6P25 – Standard OD – purple – 25 foot (Closet – server)
 - 5) HC6GN25 – Standard OD – green – 25 foot (Station / Closet – intercom / AV monitor)
 - 6) HC6GY25 – Standard OD – gray – 25 foot (Station / Closet – POS / Kronos)
 - 7) HC6R25 – Standard OD – red – 25 foot (Closet – Fire Alarm)
 - 8) HC6W25 – Standard OD – white – 25 foot (Closet – HVAC / Facility)
 - 9) HC6B25 – Standard OD – blue – 25 foot (Closet – UPS)
- g) Category 6A –
- 1) HCL6APK03 – Slim OD – pink – 3 foot (Station / Closet – Access point)
 - 2) HCL6APK05 – Slim OD – pink – 5 foot (Station / Closet – Access point)
 - 3) HCL6APK07 – Slim OD – pink – 7 foot (Station / Closet – Access point)
 - 4) HCL6APK10 – Slim OD – pink – 10 foot (Station / Closet – Access point)
 - 5) HCL6APK15 – Slim OD – pink – 15 foot (Station / Closet – Access point)
 - 6) HCL6APK25 – Slim OD – pink – 25 foot (Station / Closet – Access point)

1.25 Projector Plate:

- A. AMR
 - 1. AMRDCP100KIT – 2x2 ceiling tile insert with two (2) single gang knock-outs and projector mount knock-out
- B. AVM
 - 1. AVM-PRO-DCP-UNV-404-SV – 2x2 ceiling tile insert with four (4) single gang knock-outs and projector mount knock-out
- C. Peerless
 - 1. PRGS-455 – 2x2 ceiling tile insert with three (3) single gang knock-outs and one (1) projector mount

- D. Chief
 - 1. CMS-445 – 2x2 ceiling tile insert with single and dual electrical outlet cutouts

1.26 Projector Screens:

- A. Da-Lite
 - 1. TNSD 220D – HD DM motorized screen
 - 2. DA37022L – 16x9 (108x192) tension advantage electrol projector screen HDTV format
- B. Draper
 - 1. Access V – Ceiling-recessed, tab-tensioned screen
 - a) Black Backed Matt White XT1000VB (Opti Flex)
 - b) 120V AC Standard Voltage Motor and Control options

1.27 Projectors:

- A. EPSON
 - 1. G5950NL – PowerLite multimedia projector
- B. NEC
 - 1. PA653UL-41ZL – WUXGA conference room projector
 - 2. MP-PA703UL-41ZL – 9000 lumen projector – cafeteria installation (typical)

1.28 Raceways:

- A. Panduit
 - 1. LD – Surface raceway system
 - a) LD3 - ¾ inch surface raceway – locking cover
 - b) LD5 – 1 inch surface raceway – locking cover
 - c) LD10 – 1 ½ inch surface raceway – locking cover
 - 2. T45 – Surface raceway system
 - a) T45BIW10 – T45 raceway base 10 foot section
 - b) T45CIW10 – T45 hinged raceway cover 10 foot section
 - c) T45DW10 – T45 divider wall, 10 foot section
 - d) T45CEW – T45 end cap
 - 3. T70 – Surface raceway system
 - a) T70BIW10 – T70 raceway base 10 foot section
 - b) T70CIW10 – T70 raceway cover 10 foot section
 - c) T70DW10 – T70 raceway with divider 10 foot section
 - d) T70ECIW – T70 end cap
- B. Hubbell
 - 1. WallTrak
 - a) PW1BC5 – WallTrak low-profile, non-metallic raceway – latching system

1.29 Sound System – Components:

- A. Microphone
 - 1. Shure
 - a) BLX188/CVL-H9 – Dual Channel lavalier wireless microphone system

- b) BLX288/PG58H10 - Dual handheld wireless microphone system
 - c) CVOBC – Overhead condenser microphones
 - B. CD - Player
 - 1. Denon
 - a) DN-300Z – Cd-SD-USB player w/BT and AM/FM tuner
 - C. Amplifier
 - 1. Crown
 - a) XLi 800 – Crown Audio power amplifier
 - D. Mixer
 - 1. Yamaha
 - a) MG16 – 16 input 6-bus mixer
 - 2. Biamp (Tesira Forte)
 - a) DAN AI – Fixed audio DSP
 - E. Speaker
 - 1. JBL
 - a) SCS 8 – Spatially cued surround loudspeaker – 2-way coaxial
 - b) AC299 – Two-way full range loudspeaker
 - 1) WMB100 – Wall bracket
 - c) Pure Resonance Audio
 - 1) SD4 – 2x2 ceiling speaker array – 8 ohm/70v

1.30 Surge Protection:

- A. Circa Telecom
 - 1. Model – 1880ENA1/NSC-25 (25 Pair Indoor – 110/110 – No Cover)
 - 2. SRA 5-pin module
- B. EDCO
 - 1. COHP Series
 - 2. H Series

1.31 Wire Management – Rack:

- A. Chatsworth
 - 1. 30130-719 – 5 inch deep Horizontal Wire Manager
 - 2. 30330-719 – 7 inch deep Horizontal Wire Manager
 - 3. 30162-703 – 6 inch wide Vertical Wire Manager
 - 4. 30164-703 – 4 inch wide Vertical Wire Manager

1.32 Wireless Access Points:

- A. Cisco
 - 1. AIR-AP28021-B-K9 – Aironet Wireless Access Point – 2.4 & 5 Ghz radios
 - 2. Air-Ap3802l-B-K9 – Aironet Wireless Access point – 2.4 & 5 Ghz radios

1.33 Vaults:

- A. Hubbell

1. Quazite Systems
 - a) Quazite FRP Systems

Request for product substitution shall be submitted to SDOC Technology Services Department Technology Representative or designate no later than ten (10) days prior to quote / bid due date Unless Otherwise Noted (U.O.N)













Requests received after this time may not be considered.

END OF PRE-APPROVED PRODUCT LIST







[REMAINDER OF PAGE INTENTIONALLY LEFT BLANK]

MASTER TECHNOLOGY SYSTEMS SYMBOLS LEGEND









NETWORK DISTRIBUTION

	SINGLE PORT VOICE / DATA OUTLET
	DUAL PORT VOICE / DATA OUTLET
	QUAD PORT VOICE / DATA OUTLET
	SIX (6) PORT VOICE / DATA OUTLET
	EIGHT (8) PORT VOICE / DATA OUTLET
	VOICE / DATA OUTLET INSTALLED AT TWO (2) INCHES ABOVE COUNTER / BACKSPASH
	VOICE / DATA OUTLET INSTALLED IN DUAL CHANNEL POWER POLE RACEWAY
	FLOOR BOX VOICE / DATA OUTLET LOCATION
	JAR SYSTEMS ADAPT4 CHARGING STATION - WITH APPROPRIATE POWER
	BUILDING AUTOMATION SYSTEM CABINET - HVAC APPLICATIONS
	WIRELESS ACCESS POINT "WAP" VOICE / DATA PORT - D2 CAT6A (W/ CB-2 BRACKET)
	CEILING PLATE WITH NEMA L5 TWIST LOCK 20A / SIX (6) PORT VOICE / DATA OUTLET LOCATION
	"E" DENOTES ANY EXISTING FIELD DEVICE WHEN USED IN CONJUNCTION WITH ALL TECHNOLOGY SYSTEMS SYMBOLS





INTERCOM ANNOUNCING SYSTEM

	CEILING-MOUNT INTERIOR INTERCOM SPEAKER
	CEILING-MOUNT INTERIOR INTERCOM SPEAKER WITH IP MODULE (D-2 W/ CB-2 BRACKET)
	INTERCOM NOTIFICATION MODULE
	INTERCOM VOLUME CONTROL
	ACC3011S - MESSAGE BOARD / SPEAKER ASSEMBLY
	WALL MOUNT EXTERIOR INTERCOM HORN
	STATUS LIGHT MODULE - EXTERIOR





AUDIO SOUND SYSTEMS

	CEILING - MOUNT AUDIO SPEAKER
	WALL - MOUNT AUDIO SPEAKER
	MICROPHONE / LINE-LEVEL I/O PLATE
	SUSPENDED MICROPHONE - OVERHEAD OUTLET
	SOUND SYSTEM HEAD END AMPLIFIER AND COMPONENT ASSEMBLY CABINET
	SOUND SYSTEM CONNECTION PANEL
	AUXILIARY I/O PLATE
	INTERCOM BELT PACK WALLPLATE









AUDIO / VISUAL SYSTEM OUTLETS, ASSEMBLIES AND CONDUITS

	SMART TV (42" - 60") HEIGHT DETERMINED BY APPLICATION
	CEILING MOUNT 24" X 24" METALLIC DROP IN PROJECTOR PLATE ASSEMBLY LOCATION
	BALANCE BOX
	TEACHER STATION "TS" AUDIO / VISUAL WALL MOUNTED TEACHING WALL SUPPORT
	INTERACTIVE FLAT SCREEN MONITOR / COMPONENT, DEVICE, POWER LOCATION



CLASSROOM AUDIO ENHANCEMENT "AE" VOICE SYSTEM

	AUDIO ENHANCEMENT WALL MOUNTED VOICE SYSTEM AMPLIFIER TYPICALLY BEHIND INTERACTIVE FLAT PANEL MONITOR
	CEILING - MOUNT "AE" SPEAKER
	AUDIO ENHANCEMENT 3.5MM "AE" WALL PLATE
	AUDIO ENHANCEMENT "AE" ANTENNA

INTRUSION DETECTION SYSTEM

	ELECTRIC DOOR LOCK - ACCESS CONTROL
	DOOR CONTROLLER FOR ACCESS CONTROL / CARD READER
	VIDEO INTERCOM WEATHER-PROOF SPEAKER WITH D1 DATA OUTLET (ACCESS CONTROL)
	CARD READER - ACCESS CONTROL
	DOOR CONTACT - ACCESS CONTROL
	DOOR RELEASE OVERRIDE BUTTON
	SECURITY KEYPAD
	SECURITY MOTION DETECTOR
	SECURITY EXTERIOR SIREN / STROBE HORN / BLUE STROBE

VIDEO SURVEILLANCE SECURITY SYSTEM

	EXTERIOR VIDEO SURVEILLANCE CAMERA
	INTERIOR VIDEO SURVEILLANCE CAMERA

RADIO MASTER UNIT

	HANDHELD RADIO MASTER UNIT LOCATION
---	-------------------------------------

SDOC CONFORMED DOCUMENTS GENERAL NOTES

GENERAL NOTES:

THESE GENERAL TECHNOLOGY SYSTEMS INSTALLATION NOTES ARE FOR INSERTION ON ALL SDOC TECHNOLOGY SYSTEMS CONSTRUCTION DRAWINGS AND PLANS.

TECHNOLOGY GENERAL NOTES ARE PROVIDED TO THE ARCHITECT TO HIGHLIGHT SPECIFIC SDOC INSTALLATION CRITERIA AND AS SUPPLEMENTAL AMPLIFYING INFORMATION TO COMPLEMENT SDOC DIVISION 27 TECHNOLOGY SYSTEMS STANDARDS AND SPECIFICATIONS PROVIDED BY THE ARCHITECT AND ENGINEER ON THE CONFORMED CONSTRUCTION PLANS AND SPECIFICATIONS DOCUMENTS.

1. ALL SPACES, EQUIPMENT, CABLING, COMPONENTS, AND INSTALLATION PRACTICES SHALL BE IN ACCORDANCE WITH BICSI TELECOMMUNICATIONS DISTRIBUTION METHODS MANUAL (TDMM) 14TH EDITION AND BICSI INFORMATION TECHNOLOGY SYSTEMS INSTALLATION METHODS MANUAL (ITSIMM) 7TH EDITION.
2. CONTRACTOR SHALL MEET ALL QUALIFICATIONS AND REQUIREMENTS IN ACCORDANCE WITH SDOC DIVISION 27 STANDARDS AND SPECIFICATIONS COMMUNICATIONS 27 00 00 - SECTION 1.5.
3. DEVICE LOCATIONS FOR ALL TECHNOLOGY SYSTEMS INDICATED ON CONSTRUCTION PLANS ARE DIAGRAMMATIC ONLY. ALL PHYSICAL LOCATIONS SHALL BE FIELD LOCATED DURING A SITE WALK-THROUGH COORDINATED AND CONDUCTED BY THE TECHNOLOGY SYSTEMS ENGINEER.
4. FOR EXACT LOCATION OF CEILING MOUNTED EQUIPMENT REFER TO THE ARCHITECTURAL REFLECTED CEILING PLAN. LOCATIONS OF EQUIPMENT NOT INCLUDED ON THE REFLECTED CEILING PLAN SHALL BE COORDINATED WITH THOSE ITEMS SHOWN. COORDINATION OF CEILING MOUNTED EQUIPMENT SHALL BE COMPLETED PRIOR TO ANY ROUGH-IN. NOTIFY ENGINEER OF ANY DISCREPANCY.
5. PRIOR TO ROUGH-IN AND INSTALLATION OF ANY FLOOR MOUNTED DEVICE, VERIFY LOCATION WITH OWNER AND ARCHITECT. ALL SPACES WITH FLOOR BOXES SHALL HAVE LVT OR CARPET FLOORING.
6. PRODUCTS SHALL BE OF MATERIALS THAT ARE SUITABLE FOR THE ENVIRONMENT IN WHICH THEY ARE TO BE INSTALLED.
7. THE CONTRACTOR SHALL BE RESPONSIBLE FOR FULL COORDINATION OF ALL WORK AND EQUIPMENT IDENTIFIED IN THE DRAWINGS AND SPECIFICATIONS FOR A COMPLETE TURNKEY SOLUTION OF MULTIPLE, FULLY FUNCTIONAL TECHNOLOGY SYSTEMS AS DESCRIBED WITHIN THIS PACKAGE. ALL DEVICES, CABLING, AND MATERIAL SHALL BE CONTRACTOR PROVIDED AND INSTALLED UNLESS OTHERWISE NOTED.
8. ALL STRUCTURED CABLING SHALL BE CATEGORY 6A - RATED BEYOND 750 MHZ UNLESS OTHERWISE NOTED.
9. ALL CABLING IS TO BE HOMERUN WITHOUT SPICING UNLESS OTHERWISE NOTED. EXCEPTION: FIBER OPTIC FUSION SPLICING IS PERMITTED FOR LOOSE TUBE TERMINATIONS.
10. ALL CABLING BUNDLING SHALL USE VELCRO UNLESS OTHERWISE NOTED.
11. CONTRACTOR SHALL ENSURE ALL CONDUITS AND SLEEVES SHALL BE REAMED AND BUSHED PRIOR TO THE INSTALLATION OF ANY CABLING. ALL CONDUIT SHALL BE PROVIDED WITH PULL STRINGS OR MULE TAPE AND SECURED AT EACH END.
12. THE USE OF SURFACE MOUNTED RACEWAYS IN NEW CONSTRUCTION IS NOT ACCEPTABLE. ALL SURFACE MOUNTED RACEWAY INSTALLATION MUST BE APPROVED BY OWNER PRIOR TO INSTALLATION.
13. THE CONTRACTOR SHALL PROVIDE A SAMPLE OF LABELING FOR ALL SYSTEMS TO PROJECT ENGINEER REVIEW AND OWNER FOR REVIEW AND APPROVAL PRIOR TO COMMENCEMENT OF INSTALLATION.
14. ALL TECHNOLOGY CABLES SHALL BE LABELED ON BOTH ENDS TO IDENTIFY THE FAR END TERMINATION POINT. ALL LABELS SHALL BE TYPEWRITTEN, INDELIBLE WRAP AROUND CABLING.
15. ALL INTERCOM SYSTEM CABLING AND COMPONENTS SHALL BE RAULAND BORG, SCHOOL BOARD DIRECTED STANDARD APPROVED APRIL 03, 1990. INSTALLED INTERCOM SYSTEM SHALL BE RAULAND TCU CAMPUS IP INTERCOM SYSTEM.
16. ALL CLASSROOM AMPLIFICATION CABLING AND COMPONENTS SHALL BE AUDIO ENHANCEMENT, SCHOOL BOARD DIRECTED STANDARD APPROVED AUGUST 20, 2013.
17. TECHNOLOGY SYSTEMS CABLE BUNDLES SHALL NOT REST ON OR COME IN CONTACT WITH ANY CONDUITS, MECHANICAL SYSTEMS PIPING, VENTILATION DUCTING HANGARS, THREADED RODS, STRAPS OR OTHER SUPPORTS WHERE INSTALLED BY OTHER TRADES.
18. WHEN INSTALLED IN ACCESSIBLE CEILING SPACES, OPEN TOP CABLE SUPPORTS SHALL BE INSTALLED TO CONFORM WITH BUILDING LINES AND BE SPACED NO MORE THAN 5 FEET APART. PROVIDE TWO (2) OPEN TOP CABLE SUPPORTS AT 90 DEGREE CORNERS.
19. CABLE BUNDLES SHALL BE SECURED WITH VELCRO EVERY TWO (2) FEET AND SHALL ALSO BE SECURED TO OPEN TOP CABLE SUPPORTS.
20. CABLE SAG BETWEEN OPEN TOP CABLE SUPPORTS SHALL NOT EXCEED 2 INCHES.
21. EACH TECHNOLOGY SYSTEM CABLE SHALL BE BUNDLED SEPARATELY AND SHALL SEPARATE SUPPORT STRUCTURE.
22. TECHNOLOGY SYSTEM PATHWAYS IN ACCESSIBLE CEILING SPACES SHALL BE PROVIDED UTILIZING DEDICATED CABLE SUPPORTS RATED FOR THE RESPECTIVE CEILING SPACE, (PLENUM OR NON-PLENUM) AND INSTALLED PER APPLICABLE CODES AND STANDARDS. FOR NON-ACCESSIBLE CEILING SPACES A CONTINUOUS PATHWAY, CONDUIT SHALL BE PROVIDED.
23. ALL PATHWAYS SHALL BE SIZED AS RECOMMENDED BY THE MANUFACTURER AND APPLICABLE CODES AND STANDARDS. NO PATHWAY CABLE FILL SHALL EXCEED 40% FILL.
24. ONLY EMT OR RIGID SHALL BE USED FOR ALL CONDUIT INSTALLATIONS ABOVE GRADE.
25. SLEEVING SHALL BE INSTALLED ABOVE CEILINGS WHERE ANY CABLE PENETRATES ALL BARRIERS REGARDLESS OF FIRE OR SMOKE RATING. MINIMUM SLEEVE SIZE IS 2 INCHES UNLESS OTHERWISE NOTED AND SHALL EXTEND A MINIMUM OF 2 INCHES ON EITHER SIDE OF WALL. ALL SLEEVING SYSTEMS SHALL BE IN COMPLIANCE WITH ALL APPLICABLE CODES. ALL MATERIALS SHALL BE U/L LISTED FOR THEIR USE AND SHALL MAINTAIN THE INTEGRITY OF THE AFFECTED WALL, CEILING OR FLOOR BARRIER WITH NO EXCEPTION.
26. FOR ALL NON-RATED BARRIER INSTALLATIONS, CABLING SHALL TRANSITION THROUGH CONTRACTOR PROVIDED AND INSTALLED SLEEVING WITH NO EXCEPTION TO SDOC SATISFACTION.
27. THE CONTRACTOR SHALL PROVIDE SLEEVING OF APPROPRIATE SIZE TO ACCOMMODATE A MINIMUM 25% INCREASE IN CABLE FILL AT PROJECT COMPLETION.
28. ALL INTERIOR WALL SLEEVING INSTALLED SHALL BE CLAMPED AROUND THE OUTER SLEEVE AT THE WALL ON BOTH SIDES OF EACH WALL WITH U/L APPROVED MATERIALS TO PREVENT EACH SLEEVE INSTALLED FROM SLIDING WHEN INSTALLATION IS COMPLETE.
29. IF AN OUTLET BOX IS REQUIRED TO BE LOCATED IN AN ASSEMBLY OR PARTITION RATED AS "FIRE/SMOKE" OR "SMOKE" OR IDENTIFIED AS SUCH, THEN ALL OF THE FOLLOWING CONDITIONS SHALL BE MET:
 - a. THE OUTLET BOX SHALL BE METALLIC.
 - b. THE OUTLET BOX OPENINGS SHALL OCCUR ONLY ON ONE SIDE OF THE FRAMING SPACE.
 - c. THE OUTLET BOX OPENINGS SHALL NOT EXCEED 16 SQUARE INCHES.
 - d. ALL CLEARANCES BETWEEN THE OUTLET BOX AND THE WALL BOARD MATERIAL SHALL BE COMPLETELY SEALED WITH APPROVED MATERIALS IN ACCORDANCE WITH THE APPLICABLE CODES AND STANDARDS FOR THE PROJECT.
 - e. PROVIDE A SUPPLEMENTAL BARRIER AROUND OUTLETS LARGER THAN 16 INCHES SO THAT THE ORIGINAL RATING OF THE PENETRATION IS MAINTAINED.
 - f. THE TOTAL AGGREGATE SURFACE AREA OF THE OUTLET BOX SHALL NOT EXCEED 100 SQUARE INCHES PER 100 SQUARE FEET.
 - g. THE OUTLET BOX SHALL BE SEPARATED FROM OPENINGS ON THE OPPOSITE SIDE OF THE RATED PARTITION BY A MINIMUM HORIZONTAL DISTANCE OF 24 INCHES.
 - h. THE OUTLET BOX SHALL BE SECURELY FASTENED TO A PARTITION FRAMING MEMBER BY MEANS OF AN APPROVED ATTACHMENT METHOD.
 - i. OPENINGS CUT INTO THE WALL BOARD MATERIAL SHALL NOT EXCEED 1/8 INCH BETWEEN THE EDGES OF THE OUTLET BOX AND THE EDGES OF THE OPENING.
30. AT ALL IN-SLAB FLOOR BOX INSTALLATIONS, THE CONTRACTOR SHALL INSTALL INDOOR / OUTDOOR RATED CABLE.
31. CONTRACTOR SHALL SEAL ALL EXTERIOR PENETRATION LOCATIONS WITH U/L APPROVED WEATHER PROOF CAULK OR APPROPRIATE MECHANICAL DEVICES.
32. ALL BURIED TECHNOLOGY SYSTEMS CONDUITS SHALL BE INSTALLED AT A MINIMUM OF TWENTY-FOUR (24) INCHES BELOW FINISHED GRADE TO THE TOP OF EACH CONDUIT WITH A HORIZONTAL SEPARATION OF TWELVE (12) INCHES BETWEEN ALL POWER CONDUITS.
33. FIRE ALARM CONDUIT AND CABLING SHALL NOT BE INSTALLED IN THE SAME TECHNOLOGY SYSTEMS CONDUITS, PULLBOXES, HAND HOLES, MAN HOLES AND VAULT PATHWAYS AS TECHNOLOGY SYSTEMS CABLING IS INSTALLED.
34. THE CONTRACTOR SHALL INSTALL AND ENSURE ALL CONDUIT ENTRY PENETRATION POINTS ON THE INTERIOR AT ALL BUILDING COMMUNICATION ROOMS SHALL BE PROPERLY SEALED AND PACKED TO ELIMINATE THE POTENTIAL FOR MOISTURE, GAS, RODENT AND INSECT INTRUSION.
35. THE CONTRACTOR SHALL PROVIDE VAULTS, PULL BOXES AND HAND HOLES WHICH SHALL HAVE TRAFFIC RATED SPRING LOADED COVERS WITH COLLAPSIBLE STEEL HANDLES. COVERS SHALL BE MINIMUM TIER 15 - 20,000 LBS RATED.
36. THE CONTRACTOR SHALL INSTALL A MINIMUM TWENTY-FOUR (24) INCH AGGREGATE GRAVEL BASE AT THE OPEN FLOOR OF EACH COMMUNICATIONS VAULT AND EACH COMMUNICATIONS HAND HOLE.
37. ALL CABLES TRANSITIONING THROUGH VAULTS, PULL BOXES AND HAND HOLES SHALL BE ADEQUATELY AND APPROPRIATELY SECURED AND SUPPORTED OFF THE FLOOR TO THE SATISFACTION OF SDOC TECHNOLOGY SERVICES DEPARTMENT.
38. ALL UNDERGROUND CONDUITS SHALL BE CLEANED USING A MANDREL AFTER INSTALLATION AND PRIOR TO SYSTEM TURN-OVER.
39. BACKBONE RACEWAYS SHALL HAVE A MINIMUM SIZE OF 4 INCH UNLESS OTHERWISE NOTED.
40. SECURITY SYSTEMS (VIDEO SURVEILLANCE, ACCESS CONTROL, INTRUSION DETECTION) DEVICES AND CABLING SHOWN ON TECHNOLOGY DRAWINGS SHALL MEET ALL DIVISION 27 REQUIREMENTS.
41. IN ALL COMMUNICATION ROOMS, THE CONTRACTOR SHALL PROVIDE AND INSTALL ON ALL FOUR (4) WALLS READYSPEC MANUFACTURED BACKBOARDS UREA-FORMALDEHYDE RESIN FREE PART NUMBER #RB-A4848-PPG-FS-TU32 FACTORY PAINTED WITH FIRE RETARDANT PAINT WHITE IN COLOR ON FACTORY PROVIDED ¾ INCH "AC" GRADE PLYWOOD WITH 2 COATS ON ALL SIDES.
42. ALL READYSPEC VOICE AND DATA BACKBOARDS SHALL BE INSTALLED WITH MANUFACTURER PROVIDED FASTENERS IN ACCORDANCE WITH MANUFACTURER INSTALLATION SPECIFICATIONS.
43. ALL WALL FIELD AREAS SHALL HAVE PAINTED BORDERS CONSISTING OF TWO (2) INCH STRIPING WITH TWO (2) INCH STENCILED LETTERING OF SDOC SPECIFIED COLORS FOR EACH DESIGNATED TECHNOLOGY SYSTEM AREA. REFERENCE MDF AND IDF DETAILS.
44. ALL TELECOMMUNICATIONS OUTLETS (D-1, D-2, D-4, D-6) SHALL HAVE AN APPROPRIATELY SIZED POWER RECEPTACLE WITHIN 12 INCHES.
45. EACH RACK LOCATION IN COMMUNICATION ROOMS SHALL HAVE ONE (1) NEMA L6-30R AND ONE (1) NEMA 5-20R RECEPTACLES AT 80 INCHES ABOVE FINISHED FLOOR LOCATED ON BACKBOARD DIRECTLY BEHIND THE RACK.
46. COMMUNICATION ROOM SHALL HAVE NEMA 5-20R CONVENIENCE RECEPTACLES EVERY SIX (6) FEET AT 18 INCHES ABOVE FINISHED FLOOR.

TECHNOLOGY RESPONSIBILITY MATIX

Design					
Item	System	Scope	Design Responsibility	Procurement Responsibility	Construction Responsibility
1	Site Configuration	Complete site conduit / riser / system / underground	Architect / Engineer	Construction Manager	CM / Electrical Contractor
2	Building Configuration	Complete building / floor / riser / system / underground	Architect / Engineer	Construction Manager	CM / Electrical Contractor
Site Configuration					
Item	System	Scope	Design Responsibility	Procurement Responsibility	Construction Responsibility
3	Exterior Conduit Configuration	Conduit, Vaults, Manholes, etc.	Architect / Engineer	Construction Manager	CM / Electrical Contractor
4	Outside Plant Premise Cabling - Outside Service Providers - Property line to Campus CD (MDF) / ER (if applicable) Demarcation "DMARC" location	Technology Systems copper and fiber optic cable from Property line to CD (MDF) DMARC location	Architect / Engineer	Construction Manager	CM / Owner / Outside Service Providers - Applicable Engineering provide by Outside Providers (each discipline)
5	Outside Plant Premise Cabling - Between Building CD (MDF) / FD (IDF) locations on campus	Technology Systems copper and fiber optic cable from CD (MDF) location to each individual FD (IDF) locations campus-wide	Architect / Engineer	Construction Manager	CM / Electrical Contractor / Low Voltage Contractor
Technology Systems Configuration					
Item	System	Scope	Design Responsibility	Procurement Responsibility	Construction Responsibility
6	Campus Distribution (CD) - (MDF) / Floor Distribution (FD) - (IDF) Buildout	Space dimensions / location / orientation - Door orientation / location - Backboard orientation / locations - HVAC requirements / orientation / location - Power requirement / orientation / location - Grounding requirements / orientation / location - Lighting requirement / orientation / location - Access Control requirement / location - Rack orientation / location - Ladder rack orientation / location - Discipline orientation / location	Architect / Engineer	Construction Manager	CM / Electrical Contractor / Low Voltage Contractor

7	Raceway / Pathway	Conduit / sleeving / mechanical fire stop devices / boxes / etc.	Architect / Engineer	Construction Manager	CM / Electrical Contractor
8	Primary Cable Tray	Premise Distribution system cable trays	Architect / Engineer	Construction Manager	CM / Electrical Contractor
9	Miscellaneous Support	J-Hook / saddles / etc.	Architect / Engineer	Construction Manager	CM / Low Voltage Contractor
10	Exterior Cabling	Cabling between CD (MDF) / FD (IDF) each location	Architect / Engineer	Construction Manager	CM / Low Voltage Contractor
11	Exterior Cabling	Outside Services	Architect / Engineer	Construction Manager	CM / Owner / Outside Services (each discipline) - Installation provided by Outside Services Provider (Contractor)
12	Interior Premise Cabling	Premise Structured Cabling	Architect / Engineer	Construction Manager	CM / Low Voltage Contractor
13	Interior Intercom Cabling	Premise Structured Cabling	Architect / Engineer	Construction Manager	CM / Sole Source Contractor
14	Components (Outside Services)	Outside Services	Architect / Engineer	Construction Manager	CM / Owner / Outside Services (each discipline)
15	Components (SDOC Network)	Network requirements	Technology Services Department / Network Division (SDOC)	Owner	Owner / Technology Services Department (SDOC)
16	Components (SDOC Network)	Wireless Access	Technology Services Department / Network Division (SDOC)	Owner	CM / Low Voltage Contractor
17	Components (Intercom)	Intercom requirements	Architect / Engineer	Construction Manager	CM / Sole Source Contractor
18	Cross Connection	Technology Systems patching / cross connections of copper and fiber optic cabling / components / appliances / hardware (including all copper / fiber optic patch cords)	Technology Services Department / Network Division (SDOC)	Owner	Owner / Technology Services Department (SDOC)
Communication Location (CD - MDF / FD - IDF) Configuration					
Item	System	Scope	Design Responsibility	Procurement Responsibility	Construction Responsibility
19	Backboard	Backboard assembly / lettering / painting	Architect / Engineer	Construction Manager	CM / Electrical Contractor
20	Conduit	Technology System conduit between Technology System locations - EMT conduit (above ceiling) - appropriate conduit for underground application	Architect / Engineer	Construction Manager	CM / Electrical Contractor
21	Mechanical Fire Stop	Mechanical Fire Stop devices / appliances	Architect / Engineer	Construction Manager	CM / Electrical Contractor
22	Non-Fire Rated penetrations	EMT sleeving / support	Architect / Engineer	Construction Manager	CM / Electrical Contractor

23	Grounding Systems	Ground Bars (copper) for all Technology Systems (all locations and all applications)	Architect / Engineer	Construction Manager	CM / Electrical Contractor
24	Rack / Wire Management / Ladder Rack	Technology Systems - Rack / Wire management / ladder rack / associated hardware / devices / components - all locations and all applications	Architect / Engineer	Construction Manager	CM / Electrical Contractor / Low Voltage Contractor
Power Applications Configuration					
Item	System	Scope	Design Responsibility	Procurement Responsibility	Construction Responsibility
25	Primary Electrical	Provision / installation of dedicated general power receptacles / cabling / panels and associated power surge suppression system for Technology Systems	Architect / Engineer	Construction Manager	CM / Electrical Contractor
26	Active Electrical System	Provision / installation / testing / adjustment of power generation system	Architect / Engineer	Construction Manager	CM / Electrical Contractor
27	Uninterruptible Power Supply (UPS) Equipment	Provision / installation / testing of UPS equipment for all Technology Systems	Technology Services Department / Network Division (SDOC)	Owner	Owner / Technology Services Department (SDOC)
Distributed Antenna System					
Item	System	Scope	Design Responsibility	Procurement Responsibility	Construction Responsibility
28	Raceway / Pathway	Conduit / sleeving / mechanical fire stop devices / boxes / etc.	Architect / Engineer	Construction Manager	CM / Electrical Contractor / DAS Contractor
29	Cabling	Cabling / grounding / support	Architect / Engineer	Construction Manager	CM / Electrical Contractor / DAS Contractor
30	Components (DAS)	DAS requirements	Architect / Engineer	Construction Manager	CM / Electrical Contractor / DAS Contractor
Security Systems					
Video Surveillance					
Item	System	Scope	Design Responsibility	Procurement Responsibility	Construction Responsibility
31	Raceway / Pathway	Video Surveillance conduit / sleeving / mechanical fire stop devices / boxes / etc.	Architect / Engineer	Construction Manager	CM / Electrical Contractor
32	Interior Premise Cabling	Video Surveillance System premise cabling	Architect / Engineer	Construction Manager	CM / Electrical Contractor / Low Voltage Contractor

33	Components	Installation of Servers / cameras / exterior components / patch cords	Architect / Engineer	Construction Manager	CM / Electrical Contractor / AV Contractor
Intrusion Detection					
Item	System	Scope	Design Responsibility	Procurement Responsibility	Construction Responsibility
34	Raceway / Pathway	Intrusion Detection conduit / sleeving / mechanical fire stop devices / boxes / etc.	Architect / Engineer	Construction Manager	CM / Electrical Contractor
35	Interior Premise Cabling	Intrusion Detection System cabling	Architect / Engineer	Construction Manager	CM / Electrical Contractor / DMP Contractor
36	Components	Provision / installation of control panels / keypads / sensors / strobes / horns / etc.	Architect / Engineer	Construction Manager	CM / Electrical Contractor / DMP Contractor
Access Control					
Item	System	Scope	Design Responsibility	Procurement Responsibility	Construction Responsibility
37	Raceway / Pathway	Access Control conduit / sleeving / mechanical fire stop devices / boxes / etc.	Architect / Engineer	Construction Manager	CM / Electrical Contractor
38	Interior Premise Cabling	Access Control System cabling	Architect / Engineer	Construction Manager	CM / Electrical Contractor / Low Voltage Contractor
39	Components	Provision / installation / of control panels / readers / magnets/ electronic locking system	Architect / Engineer	Construction Manager	CM / Electrical Contractor / Access Control Contractor
Gate Control					
Item	System	Scope	Design Responsibility	Procurement Responsibility	Construction Responsibility
40	Raceway / Pathway	Conduit / sleeving / mechanical fire stop devices / boxes / etc.	Architect / Engineer	Construction Manager	CM / Electrical Contractor
41	Exterior Cabling	Gate Control Cabling	Architect / Engineer	Construction Manager	CM / Electrical Contractor / Gate Control Contractor / Low Voltage Contractor
42	Components	Provision / installation of entrance / exit gate control / transmitters / receivers / detectors / sensors (infrared / light / edge) / keypad (with hood) / pedestal	Architect / Engineer	Construction Manager	CM / Electrical Contractor / Gate Control Contractor / Low Voltage Contractor
Radio System					
Item	System	Scope	Design Responsibility	Procurement Responsibility	Construction Responsibility

43	Raceway / Pathway	Conduit / sleeving / mechanical fire stop devices / boxes / etc.	Architect / Engineer	Construction Manager	CM / Electrical Contractor
44	Cabling	Cabling / grounding / support	Architect / Engineer	Construction Manager	CM / Electrical Contractor / Radio Contractor
45	Components	Provision / installation of Master Radio headend unit / license / antenna / mast / etc.	Architect / Engineer	Construction Manager	CM / Electrical Contractor / Radio Contractor

Audio / Visual System

Classroom System

Item	System	Scope	Design Responsibility	Procurement Responsibility	Construction Responsibility
46	Raceway / Pathway	Conduit / sleeving / mechanical fire stop devices / boxes / etc.	Architect / Engineer	Construction Manager	CM / Electrical Contractor
47	Balance Box Mount	Balance Box / in wall backing to sustain minimum 250 pounds mounted	Architect / Engineer	Construction Manager	CM / Electrical Contractor
48	Interior Premise Cabling	HDMI / Teacher Station	Architect / Engineer	Construction Manager	CM / Electrical Contractor / Low Voltage Contractor
49	Components	HDMI / Teacher Station	Architect / Engineer	Construction Manager	CM / Electrical Contractor / Low Voltage Contractor
50	Monitor (Interactive)	SMART MX-275 (or equivalent) interactive Flat Panel Monitor	Architect / Engineer	Construction Manager	CM / Low Voltage Contractor
51	Monitor (Flat Panel)	52" Flat Panel Monitor (or equivalent)	Architect / Engineer	Construction Manager	CM / Low Voltage Contractor
52	Audio Enhancement	Classroom Amplification System	Architect / Engineer	Construction Manager	CM / Sole Source Contractor
53	Performance / Athletic A/V Systems	Projector / screen / sound system/cafetorium / theater / gymnasium / stadium / active-passive equipment / hardware / cabling / supports / pathways	Architect / Engineer	Contractor	Contractor

Video Wall

Item	System	Scope	Design Responsibility	Procurement Responsibility	Construction Responsibility
54	Raceway / Pathway	Conduit / sleeving / mechanical fire stop devices / boxes / etc.	Architect / Engineer	Construction Manager	CM / Electrical Contractor
55	Interior Premise Cabling	Cabling / grounding / support	Architect / Engineer	Construction Manager	CM / Electrical Contractor / Low Voltage / AV Contractor

56	Components	Video Wall components / devices / hardware	Architect / Engineer	Construction Manager	CM / Electrical Contractor / Low Voltage / AV Contractor
Display Monitors					
Item	System	Scope	Design Responsibility	Procurement Responsibility	Construction Responsibility
57	Raceway / Pathway	Conduit / sleeving / mechanical fire stop devices / boxes / etc.	Architect / Engineer	Construction Manager	CM / Electrical Contractor
58	Interior Premise Cabling	Cabling / grounding / support	Architect / Engineer	Construction Manager	CM / Electrical Contractor / Low Voltage
59	Components	Stream Beam	Architect / Engineer	Construction Manager	CM / Electrical Contractor / Low Voltage
Elevator Communication System					
Item	System	Scope	Design Responsibility	Procurement Responsibility	Construction Responsibility
60	Raceway / Pathway	Conduit / sleeving / mechanical fire stop devices / boxes / etc.	Architect / Engineer	Construction Manager	CM / Electrical Contractor
61	Interior Premise Cabling	Cabling / grounding / support / cross-connection	Architect / Engineer	Construction Manager	CM / Electrical Contractor / Low Voltage
62	Components	Emergency 2-way communication components / devices / hardware / cabling	Architect / Engineer	Construction Manager	CM / Electrical Contractor / Low Voltage / Elevator Contractor
REMAINDER OF PAGE INTENTIONALLY LEFT BLANK					

SCHOOL DISTRICT OF OSCEOLA COUNTY

DIVISION 27

STANDARDS AND SPECIFICATIONS

REVISION LOG

Section 27 00 00	Revised 10.18.2021
COMMUNICATIONS SYSTEMS	
Section 27 05 26	Revised 10.18.2021
GROUNDING – BONDING	
Section 27 05 28	Revised 10.18.2021
PATHWAYS FOR COMMUNICATIONS SYSTEMS	
Section 27 05 36	Revised 10.18.2021
CABLE TRAYS FOR COMMUNICATIONS SYSTEMS	
Section 27 11 10	Revised 10.18.2021
TELECOMMUNICATIONS SPACES, EQUIPMENT AND FITTINGS	
Section 27 13 13	Revised 10.18.2021
COMMUNICATIONS COPPER BACKBONE CABLING	
Section 27 13 23	Revised 10.18.2021
COMMUNICATIONS OPTICAL FIBER BACKBONE CABLING	
Section 27 15 13	Revised 10.18.2021
COMMUNICATIONS HORIZONTAL COPPER CABLING	
Section 27 15 43	Revised 10.18.2021
COMMUNICATIONS FACEPLATES AND MODULES	
Section 27 16 19	Revised 10.18.2021
COMMUNICATIONS PATCH CORDS, STATION CORDS AND CROSS CONNECT CABLING	
Section 27 21 33	Revised 10.18.2021
WIRELESS ACCESS POINT SYSTEMS	
Section 27 41 16	Revised 10.18.2021
CLASSROOM AMPLIFICATION SYSTEM	
Section 27 51 23	Revised 10.18.2021
EDUCATIONAL INTERCOM AND PROGRAM CLOCK SYSTEM	
Section 27 53 21	Revised 10.18.2021
DISTRIBUTED ANTENNA SYSTEM – PUBLIC SAFETY	
Section 28 10 00	Revised 10.18.2021
ACCESS CONTROL	
Section 28 20 00	Revised 10.18.2021
VIDEO SURVEILLANCE	
Section 28 30 00	Revised 10.18.2021
INTRUSION DETECTION	

PRE-APPROVED PRODUCT LIST	Revised 10.18.2021
MASTER SYMBOLS	Revised 10.18.2021
GENERAL NOTES	
RESPONSIBILITY MATRIX	
REVISION LOG	Revised 10.18.2021
TABLE OF CONTENTS	Revised 10.18.2021

DETAILS

(FOR REFERENCE ONLY – NOT FOR GENERAL PUBLICATION)

ACCESS CONTROL	
AUDIO ENHANCEMENT (ENCLOSURE)	Revised 10.18.2021
BALANCE BOX	
BAS – SUPPORT OUTLET (DATA)	
CAFETORIUM PROJECTOR PLATE	
CAMERA BUILDOUT	
CHARGING STATION (ADEPT4)	Revised 10.18.2021
CHARGING STATION (JARS 1610)	
CONDUIT – TRENCHING / BORING	
DATA OUTLET (D4)	
DATA OUTLET (CONDUIT)	
EXTERIOR WAP BUILDOUT	
GROUNDING BUS BAR	
HANDHOLE (SMALL VAULT)	
IDF (FD) CABINET	
IDF (FD) RACK LAYOUT	
IFSM OUTLET	
IFSM CONDUIT-BOX ROUGHIN	
IFSM TEACHING WALL CONFIGURATION	
INTERIOR INTERCOM SPEAKER BUILDOUT	Revised 10.18.2021
INTERIOR INTERCOM MESSAGE BOARD BUILDOUT	Revised 10.18.2021
INTERIOR WAP BUILDOUT	
INTERIOR WAP (WALL MOUNT) BUILDOUT	
LABELING	
MDF (CD) RACK LAYOUT	
PROJECTOR PLATE ASSEMBLY	
TEACHER STATION OUTLET	
TEACHER STATION OUTLET (HUBBELL)	
TERMINATION (568 A)	
VAULT (COMMUNICATION)	

SYSTEMS

(SEE DESIGN GUIDELINES – SDOC FACILITY DEPARTMENT)
(FOR REFERENCE ONLY – NOT FOR GENERAL PUBLICATION)

BACKBONE (BONDING) – RISER DIAGRAM
BACKBONE (CABLING / CONDUIT) – RISER DIAGRAM
CAFETORIUM AUDIO / VISUAL – BLOCK DIAGRAM
EMS / DAS – RISER DIAGRAM
GYMNASIUM SOUND SYSTEM – DIAGRAM
HIGH SCHOOL CAFETERIA (AUDIO / VISUAL) – BLOCK DIAGRAM
HIGH SCHOOL THEATER (AUDIO / VISUAL) – DIAGRAM
IDF (FD) SPACE CONFIGURATION – DIAGRAM
MDF (CD) SPACE CONFIGURATION – DIAGRAM
STADIUM SOUND SYSTEM – DIAGRAM
VIDEO WALL – DIAGRAM

TYPICAL ARCHITECTURAL / ENGINEERING DETAILS

(SEE DESIGN GUIDELINES – SDOC FACILITY DEPARTMENT)
(FOR REFERENCE ONLY – NOT FOR GENERAL PUBLICATION)

BLACK BOX THEATER	
CAFETORIUM (ELEMENTARY / MIDDLE)	Revised 10.18.2021
CLASSROOM (ELEMENTARY)	Revised 10.18.2021
CLASSROOM (ELEMENTARY SKILLS)	Revised 10.18.2021
CLASSROOM (CET)	Revised 10.18.2021
CLASSROOM (MIDDLE)	Revised 10.18.2021
CLASSROOM (MIDDLE SKILLS – CONFIGURATION A)	Revised 10.18.2021
CLASSROOM (MIDDLE SKILLS – CONFIGURATION B)	Revised 10.18.2021
CLASSROOM (PORTABLE)	Revised 10.18.2021
CONFERENCE ROOM	
FRONT OFFICE SUITE (INCLUDING LOBBY)	
GYMNASIUM	
HIGH SCHOOL CAFETERIA	
KITCHEN (INCLUDING SERVING AREA)	
MEDIA CENTER	
MUSIC SUITE	
THEATER (HIGH SCHOOL)	

[REMAINDER OF PAGE INTENTIONALLY LEFT BLANK]

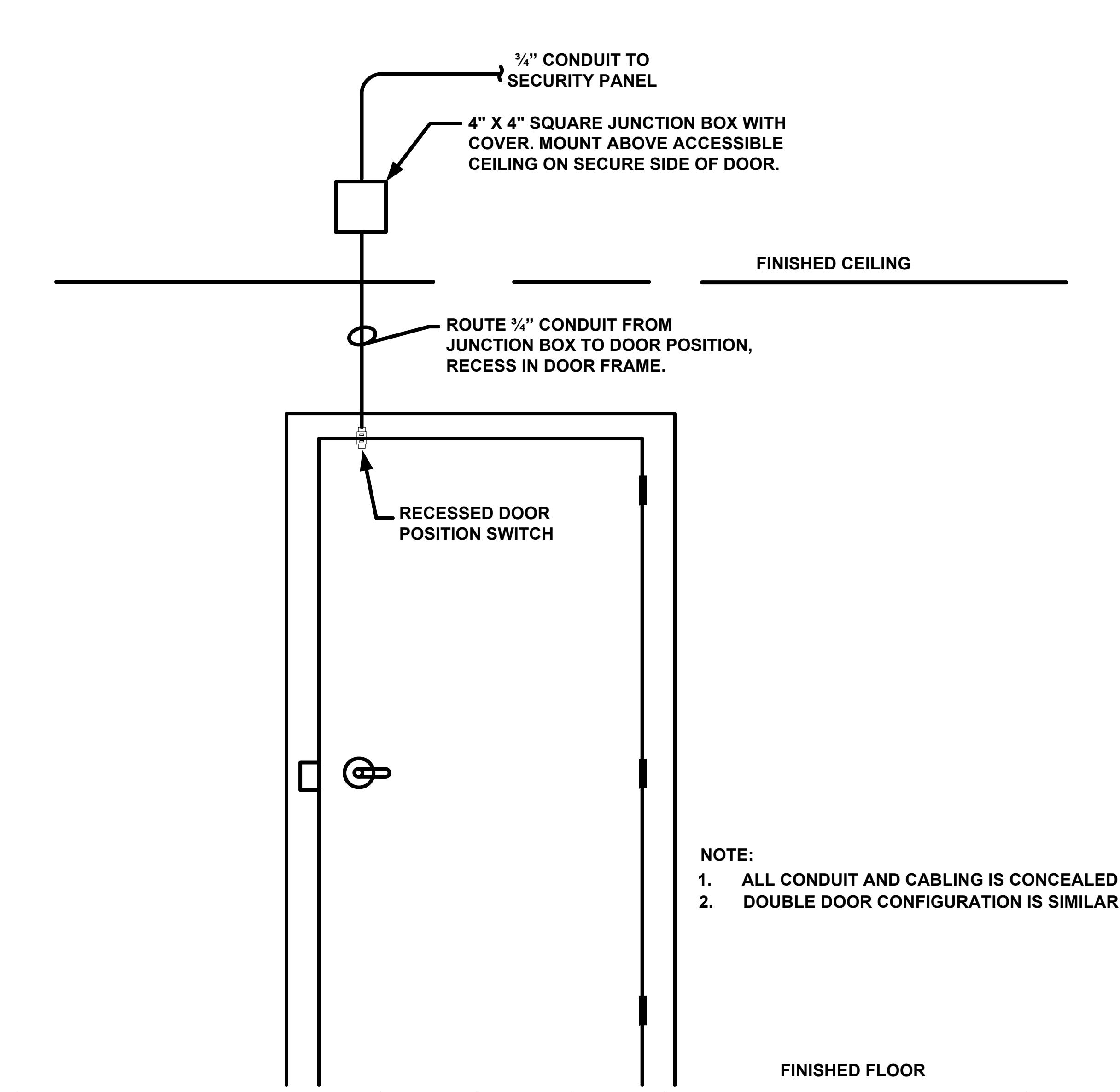

SINGLE DOOR WITH DOOR CONTACTS

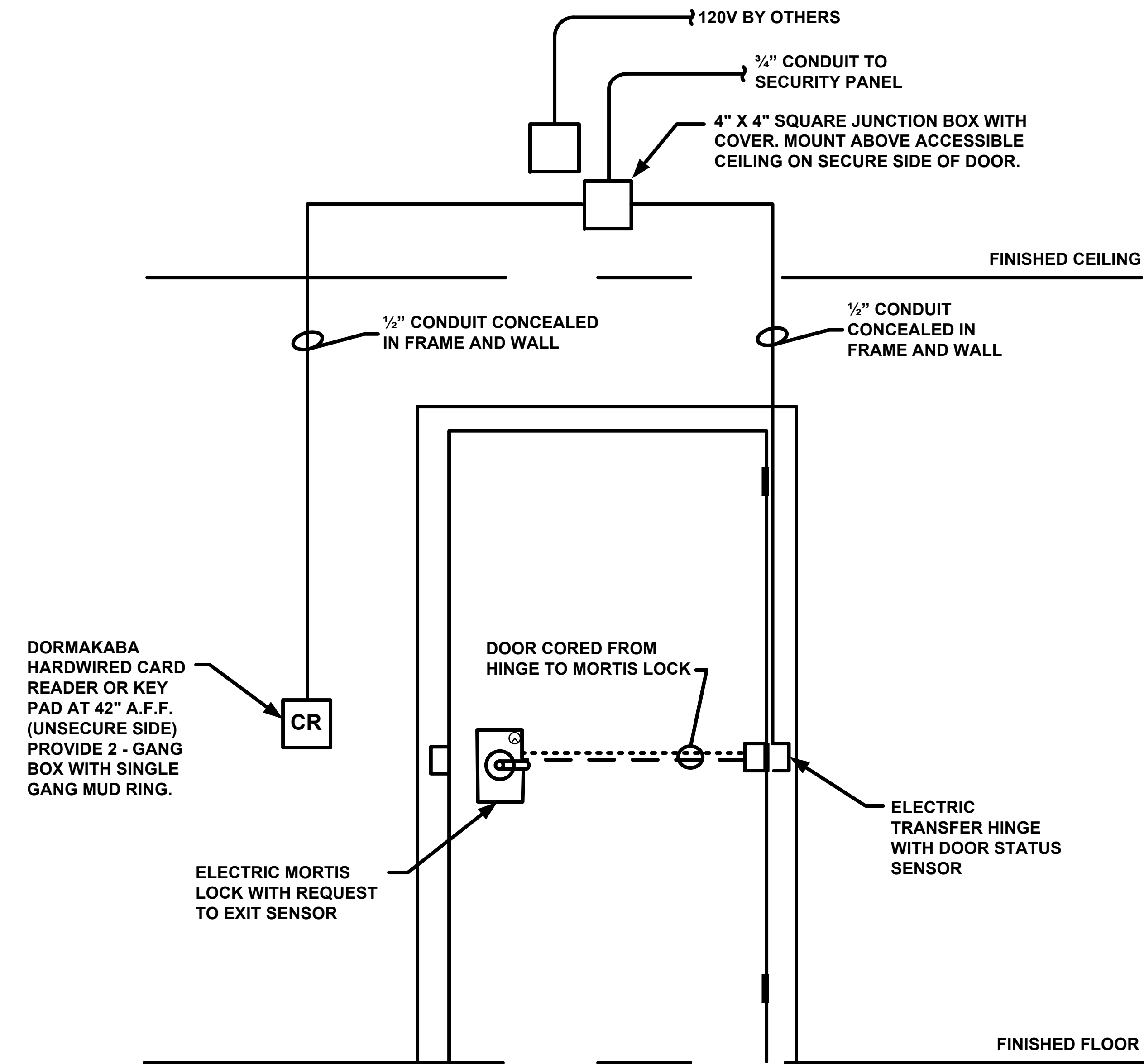

SINGLE DOOR WITH CARD READER / KEYPAD

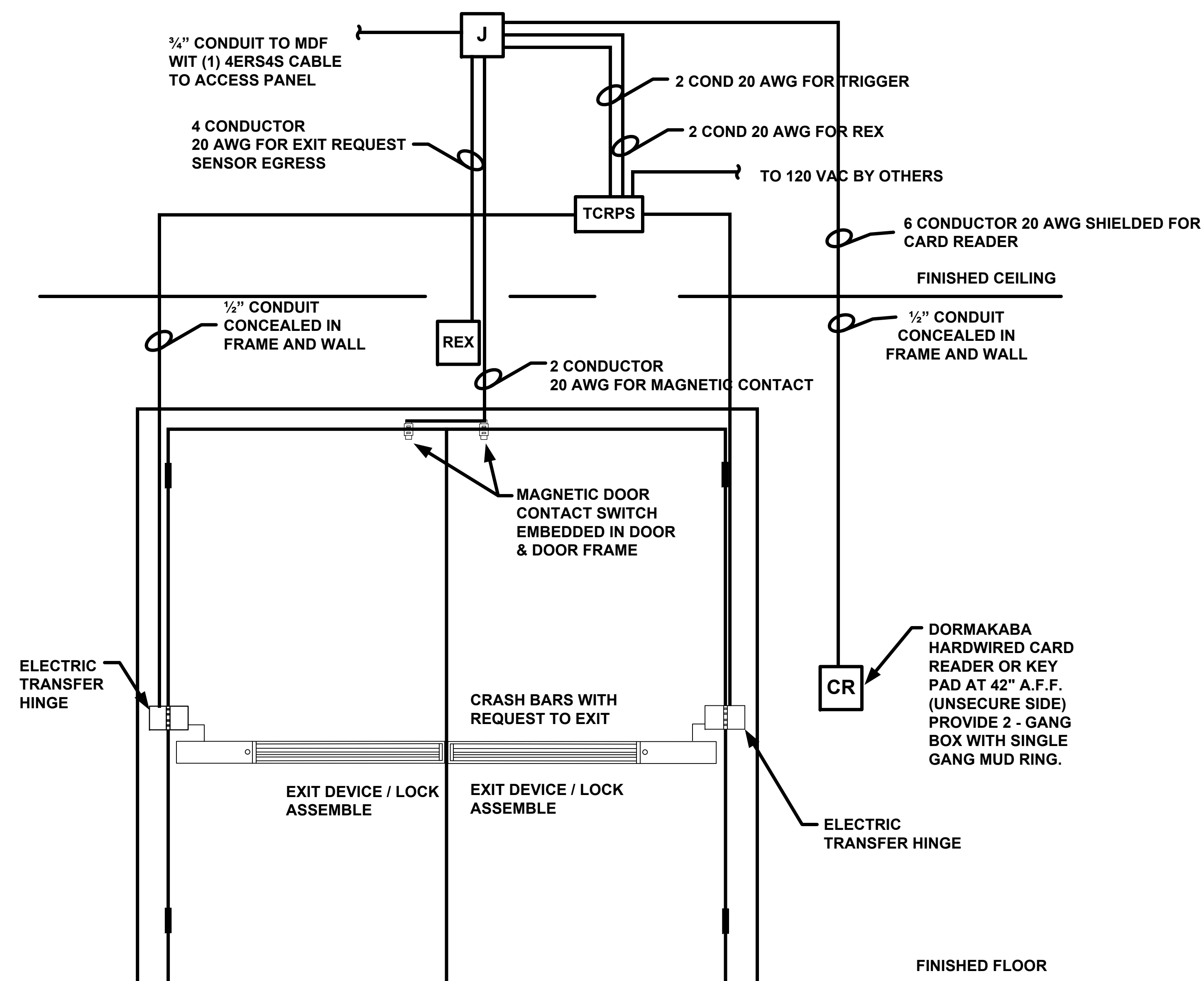

**DOUBLE DOOR WITH CARD READER / KEYPAD
MAGNETIC RELEASE**

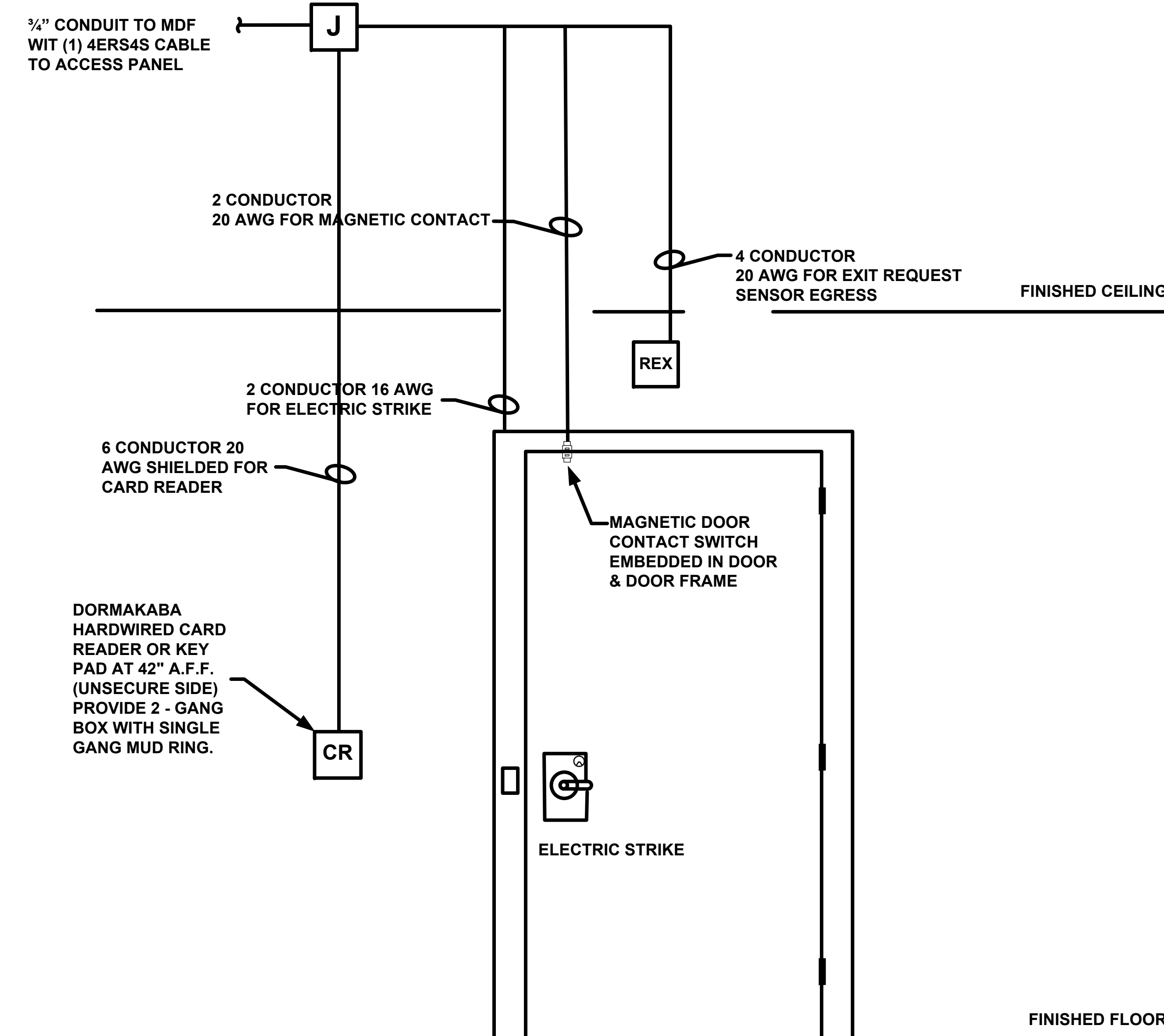

**SINGLE DOOR WITH CARD READER / KEYPAD
MAGNETIC RELEASE**

ACCESS CONTROL DETAILS

NOT TO SCALE

Exterior Protective Enclosure

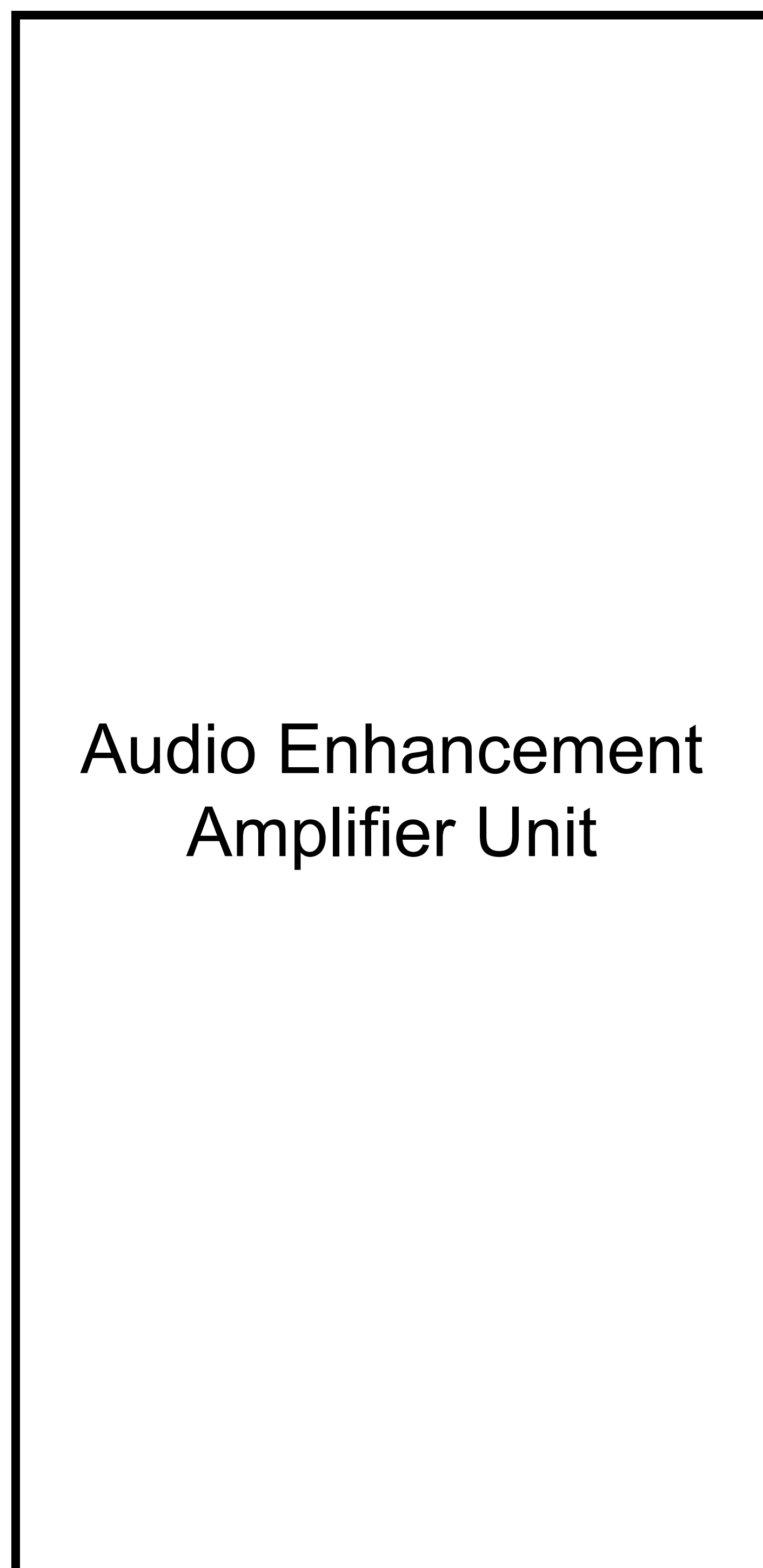

Dedicated 20 amp
circuit

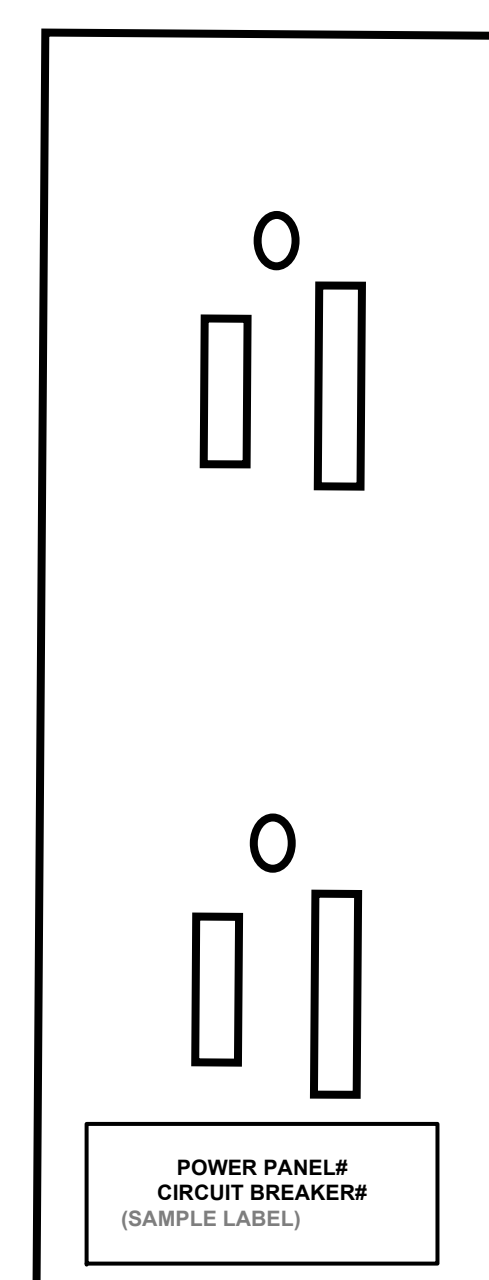

Audio Enhancement Surface Mount Application

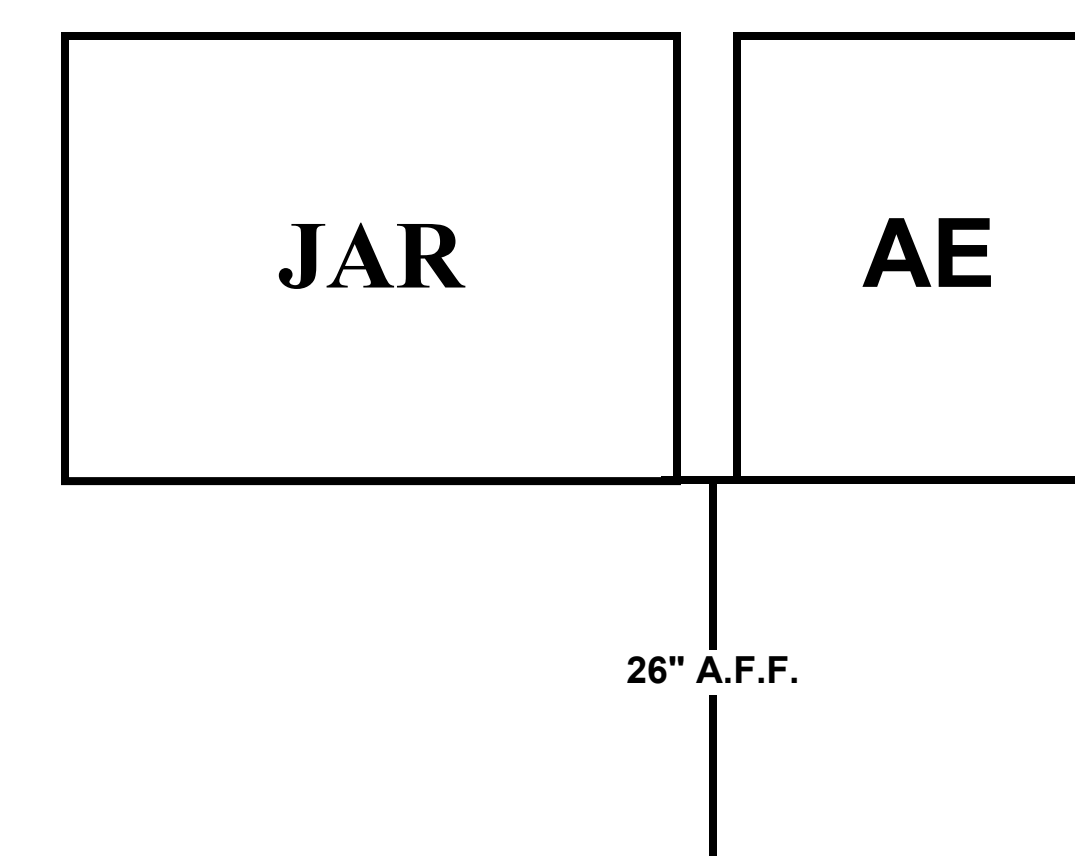

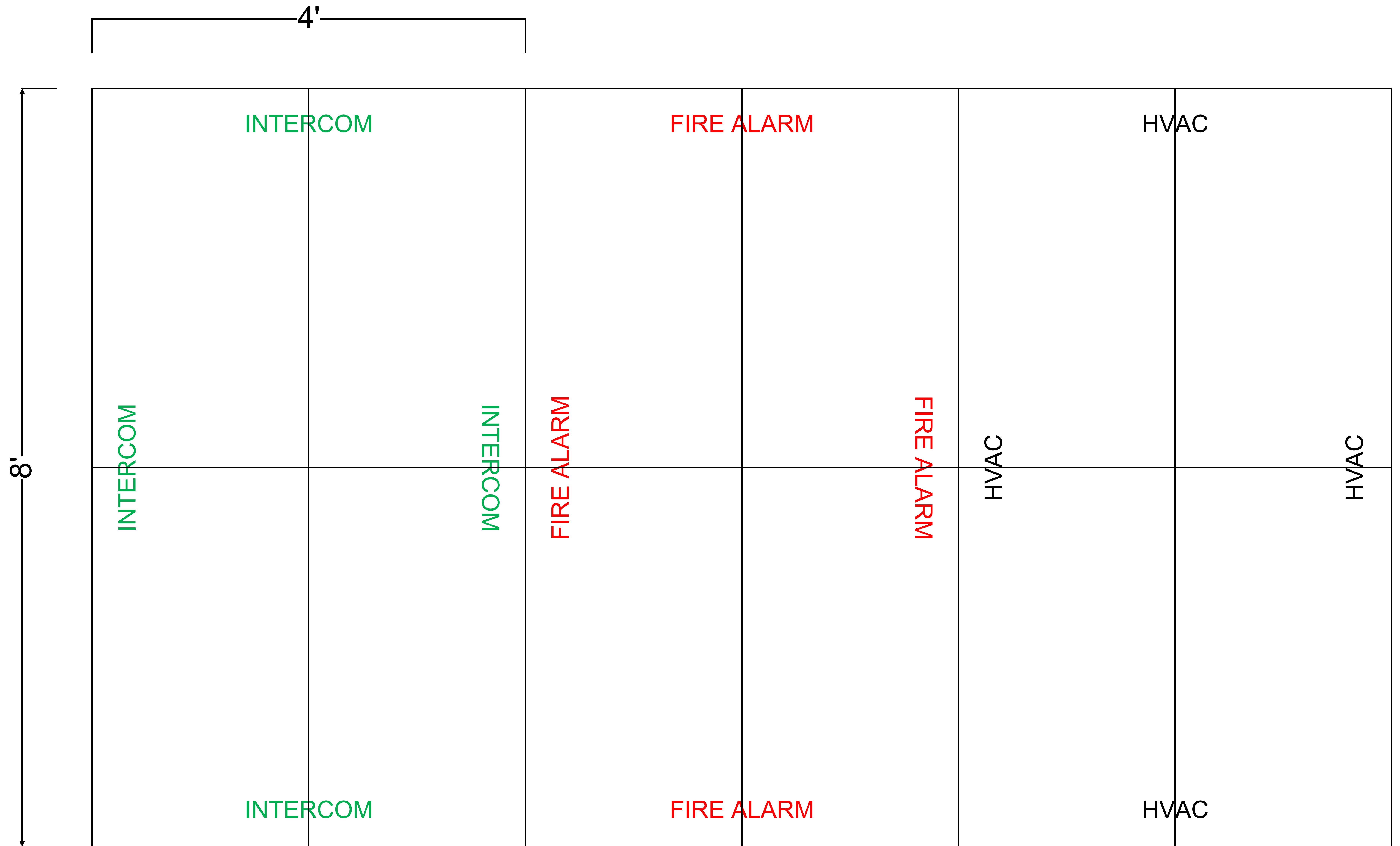

SAMPLE BACKBOARD LAYOUT

Not to Scale

Ceiling Height (Approximately 9')

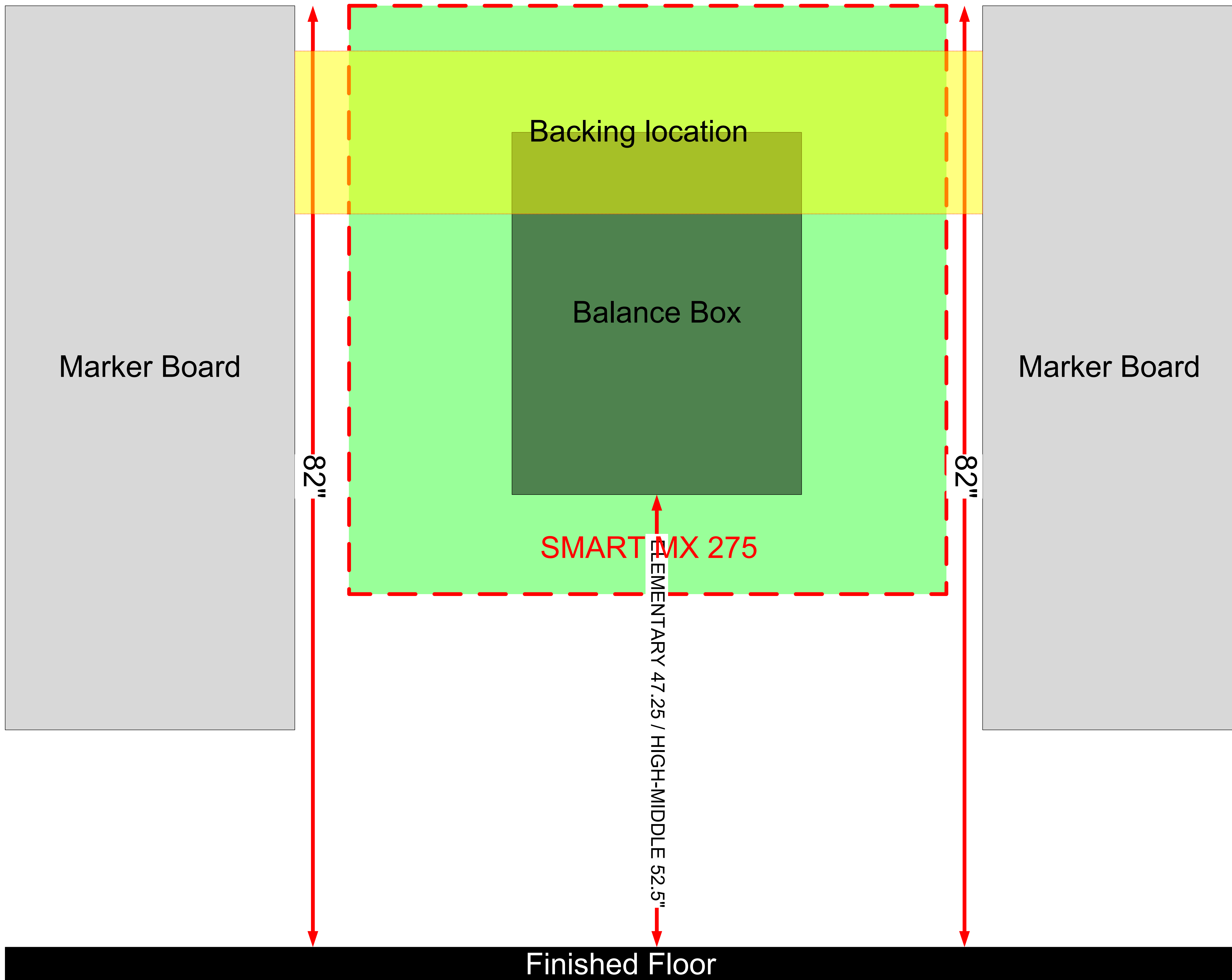

Balance Box Heights

Not to Scale

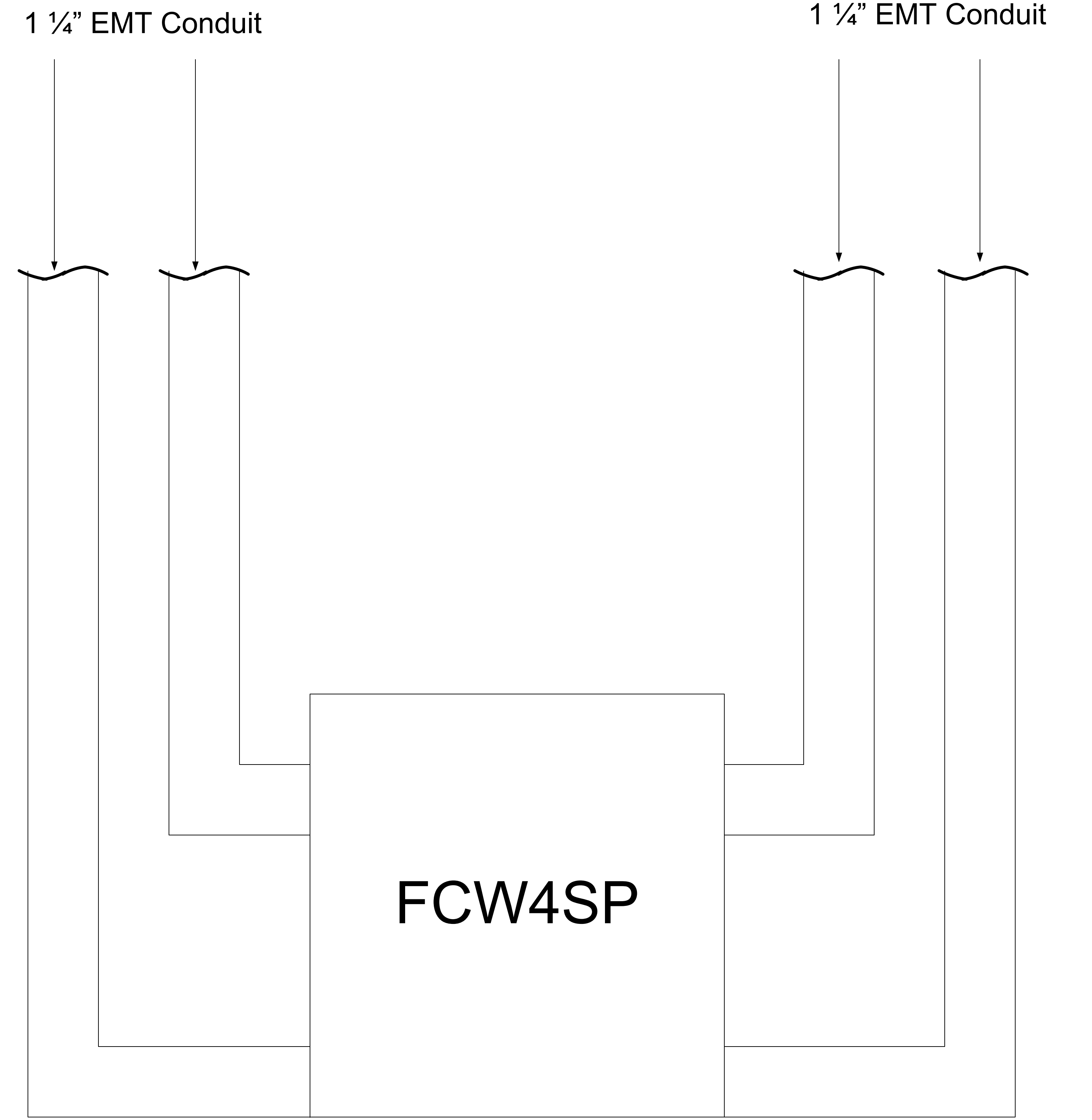
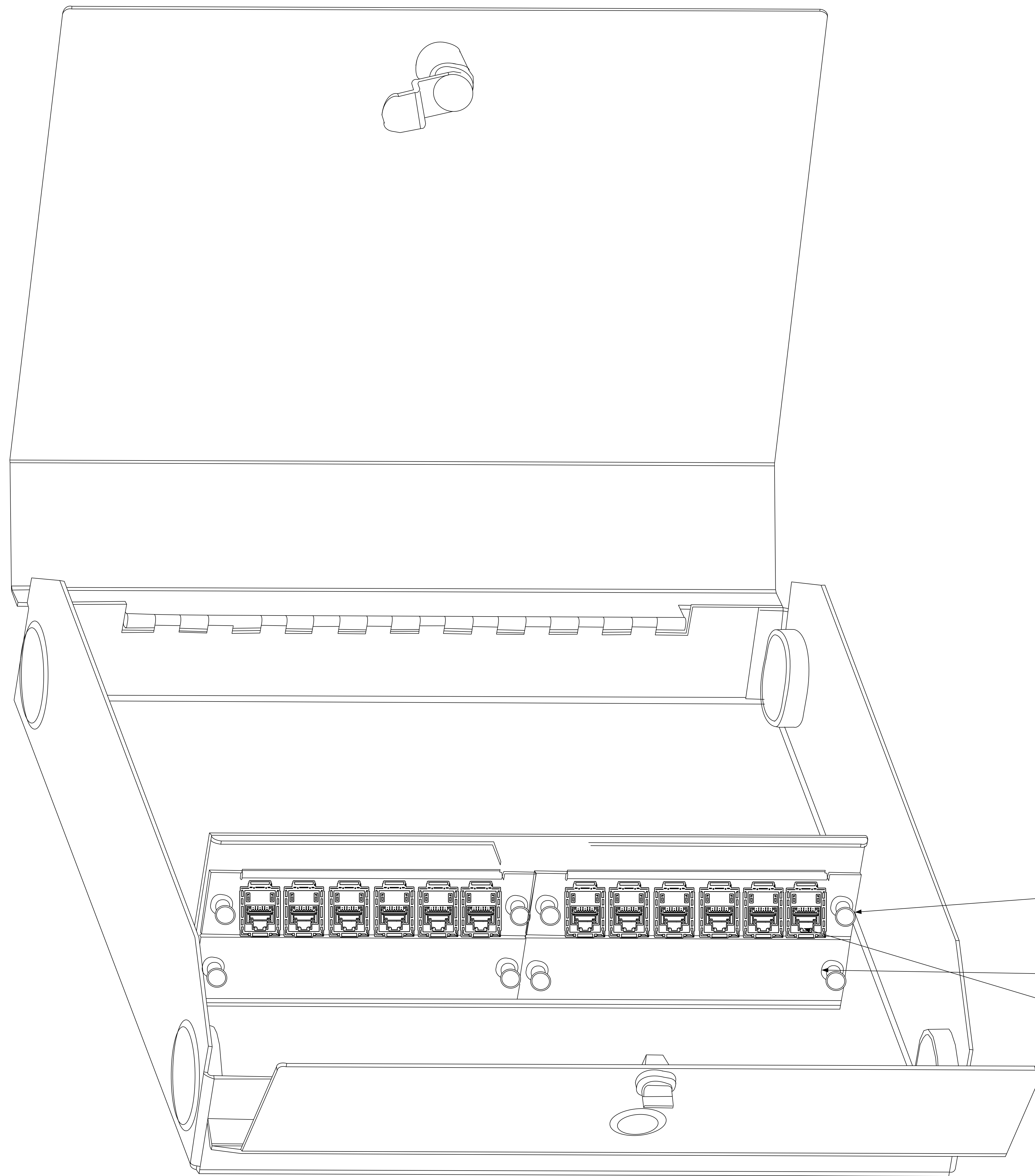

FSPHD6X (2)

FSPB (2)

HXJ6W

HVAC - BAS SUPPORT OUTLET

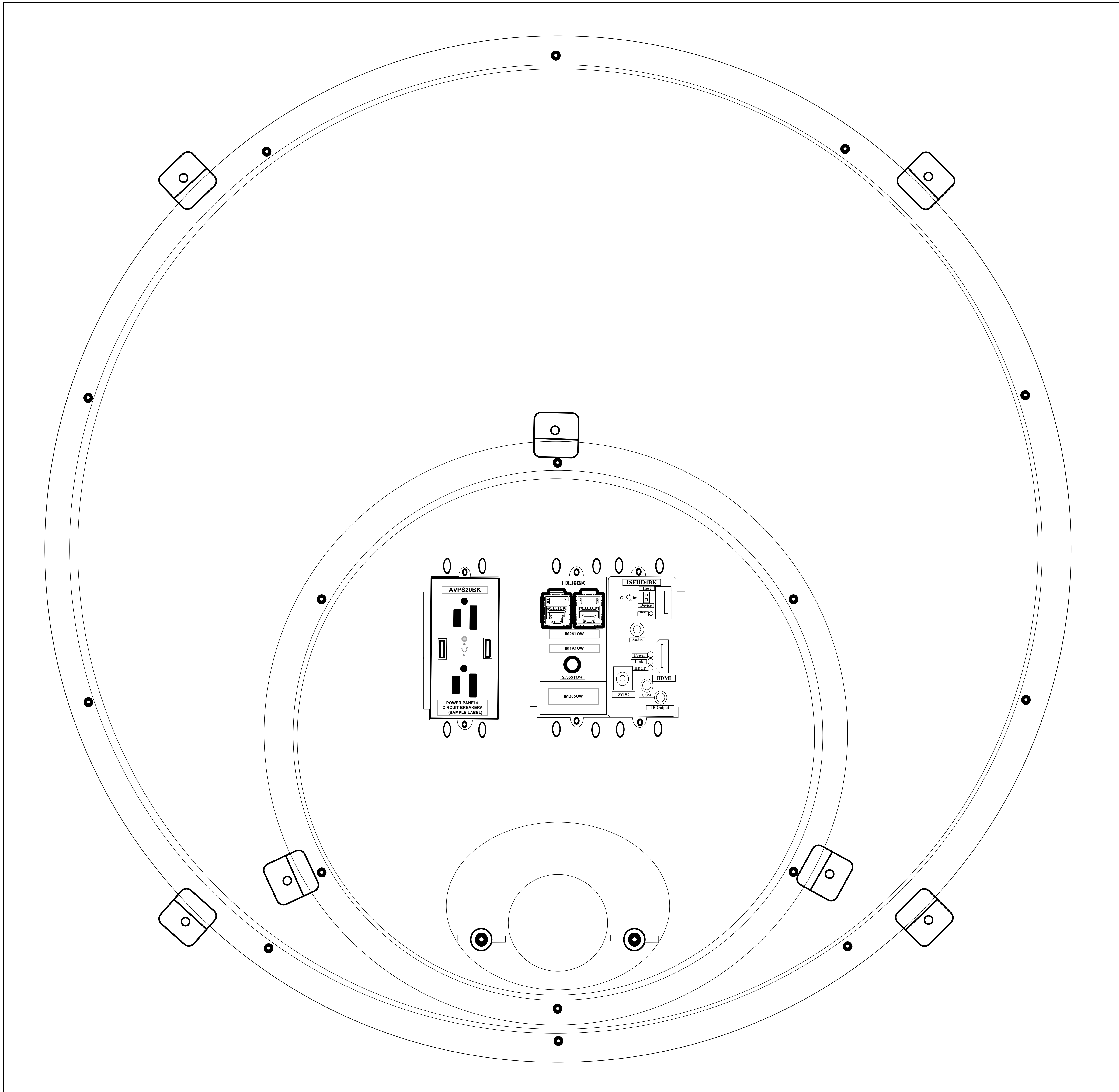

Note:
Typical 4K extender cabling homerun to presentation podium or control booth
Typical 3.5 mm audio cabling homerun to amplification system
Typical data cabling homerun to closest MDF / IDF location (CAT 6)

Typical projector
NEC NP-PA653UL-41ZL
or equivalent
Lens based on distance to screen

Typical Extension CMS0203 - 24" - 36"
or equivalent

Typical Mount VCMU
or equivalent

Typical Plate CMS445-T
or equivalent

Typical
Cafetorium
Projector Plate
Assembly

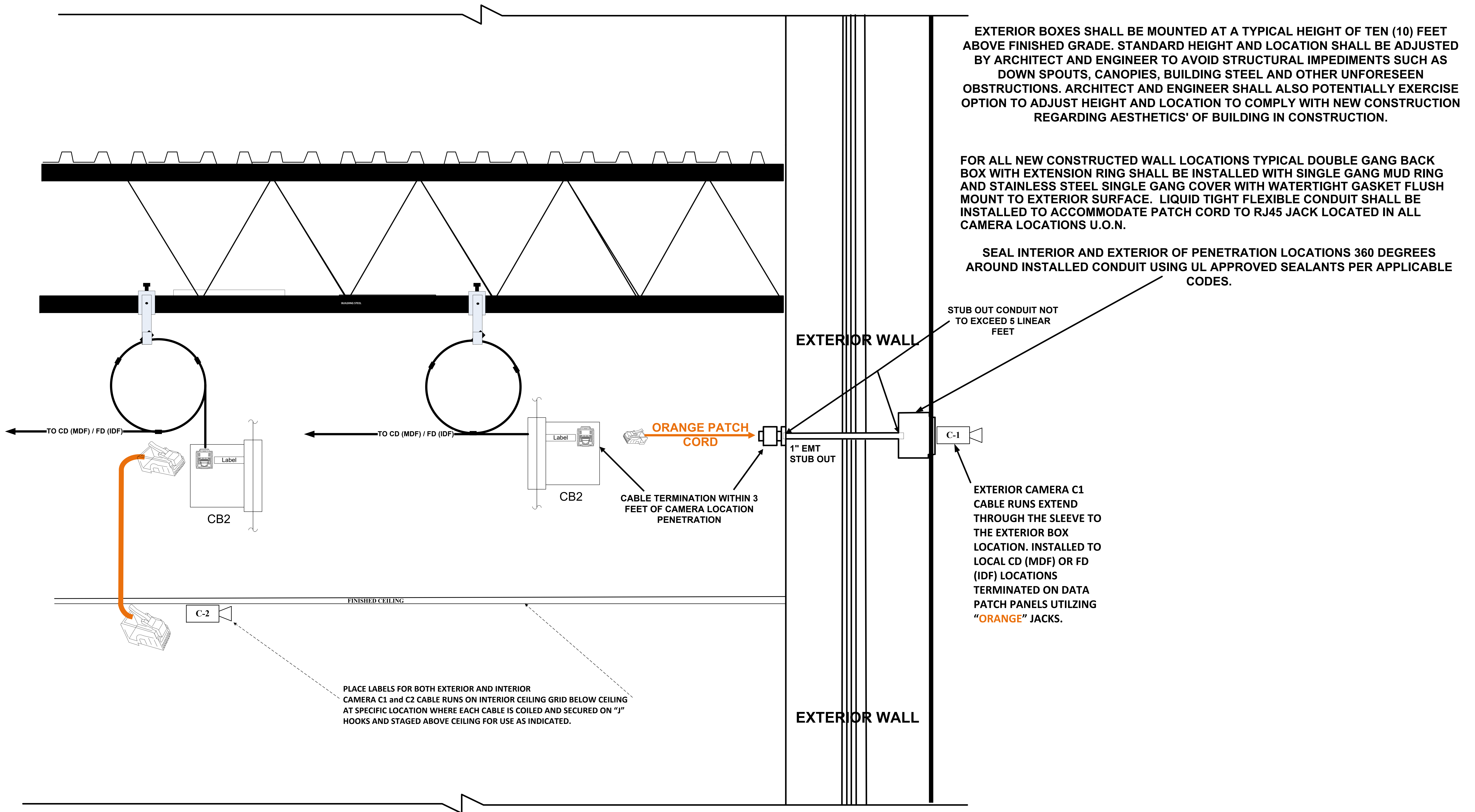

C1 EXTERIOR AND C2 INTERIOR CAMERA CABLE INSTALLATION LOCATION DETAILS
"TYPICAL"
 Not to scale

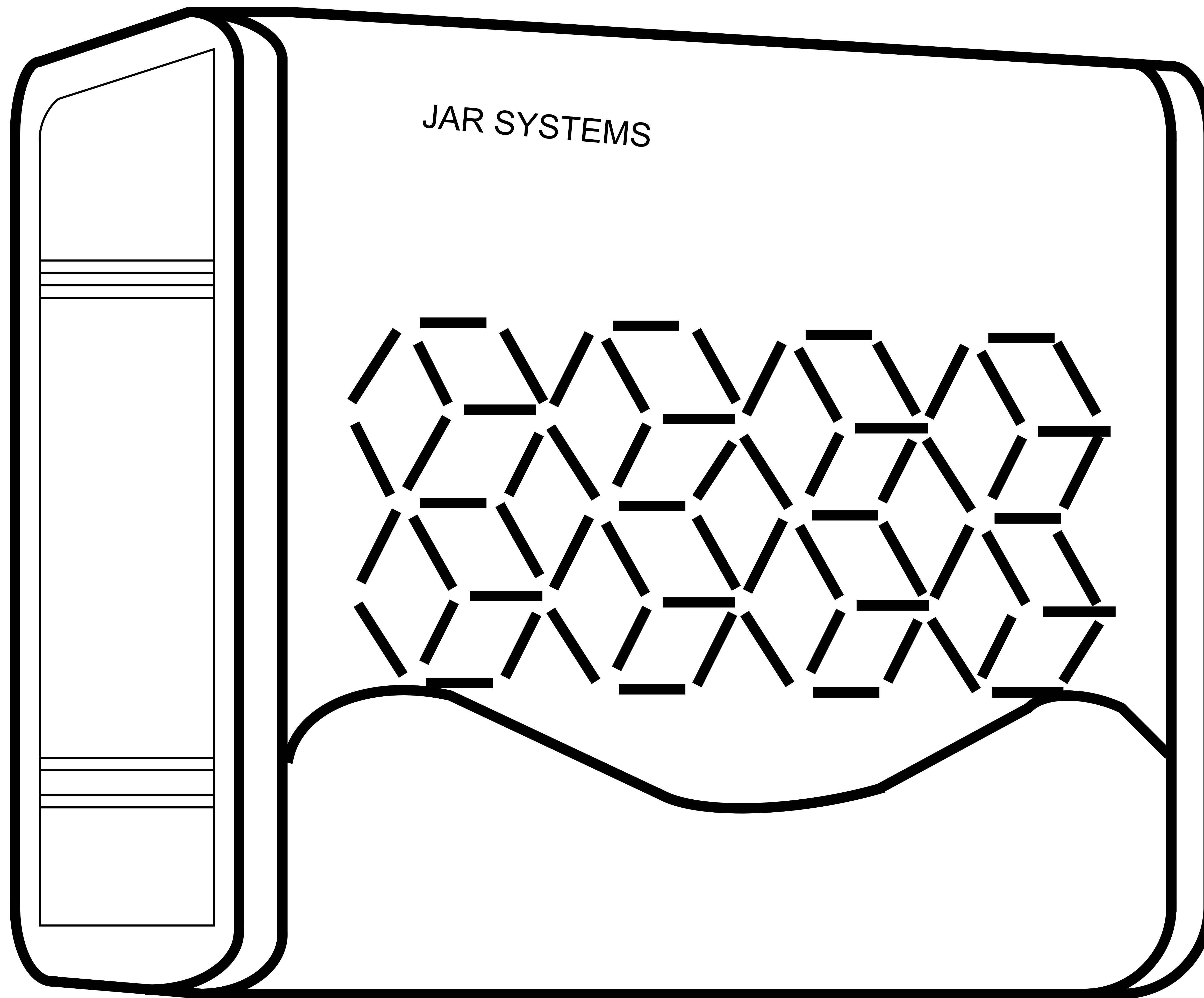

JAR SYSTEMS
ADAPT4
CHARGING
SYSTEM

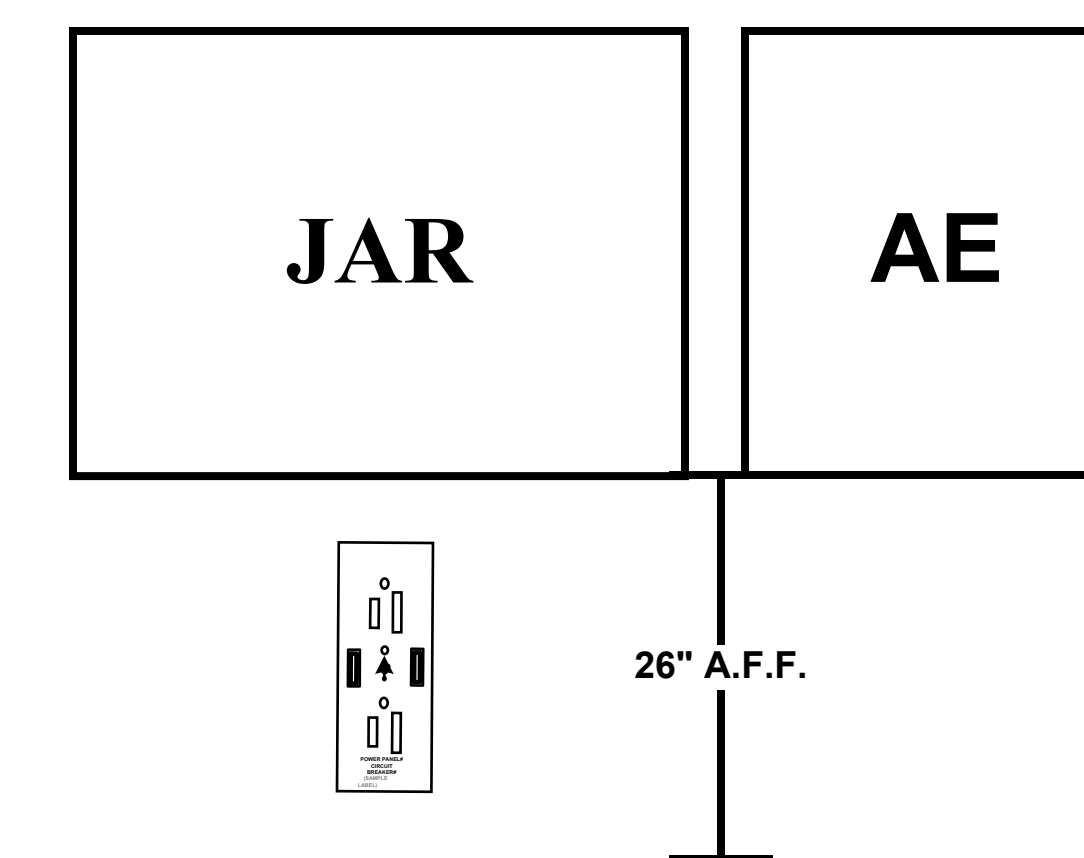

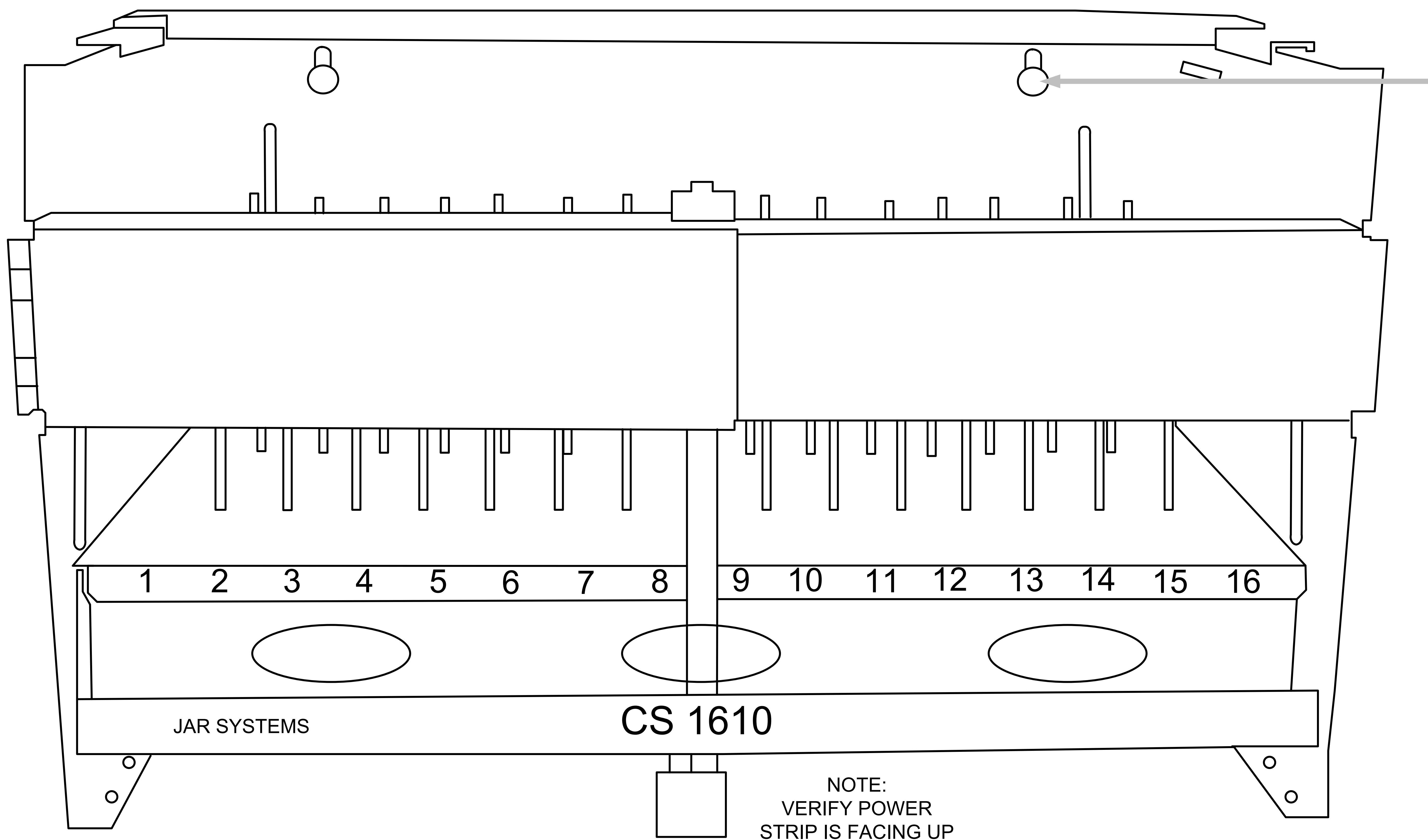

(4) Toggler High Performance Anchors
1/4" Toggle Bolts

NOTE:
VERIFY POWER STRIP IS FACING UP

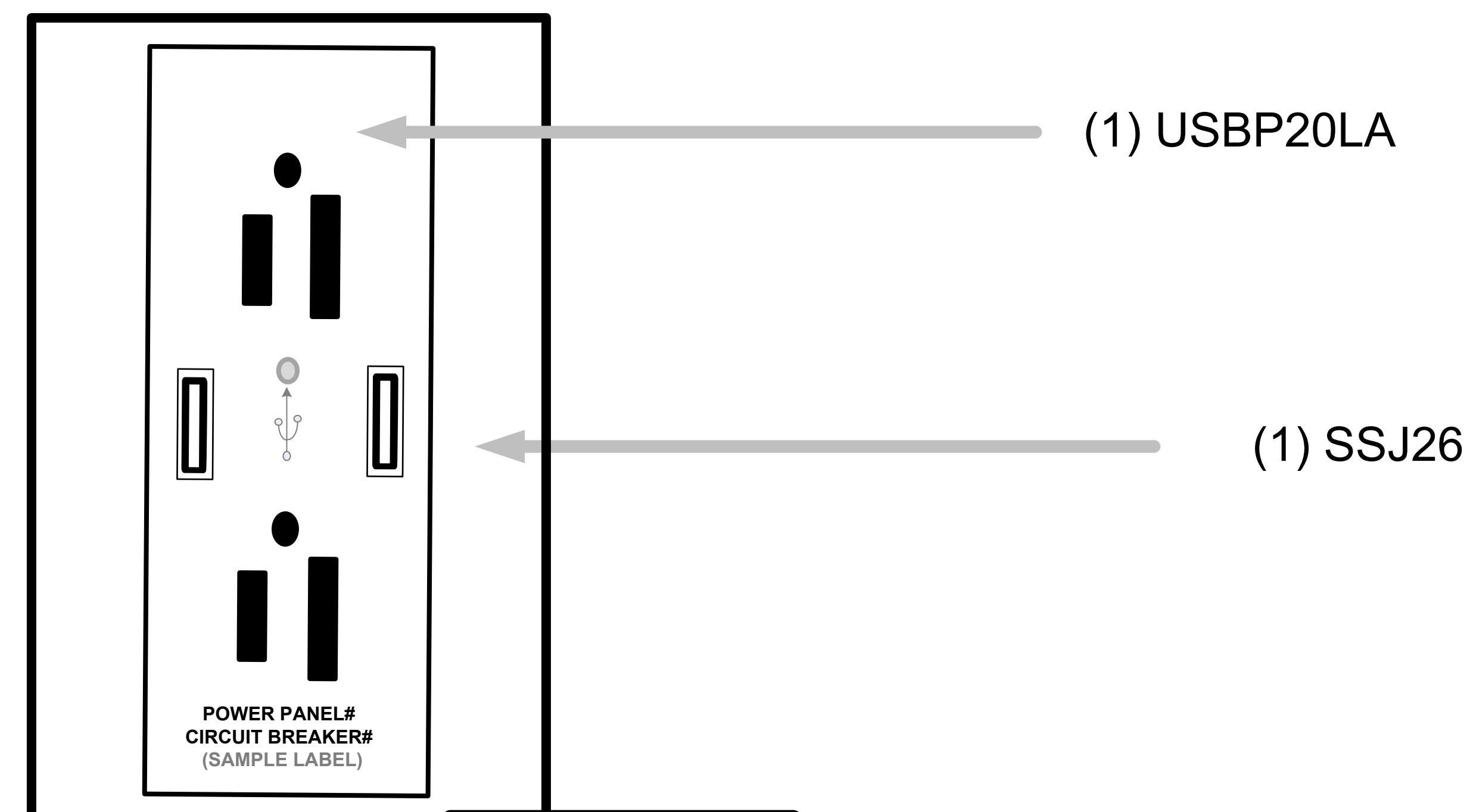

NOTE: ENGINEER TO DETERMINE APPROPRIATE POWER REQUIREMENTS. DUPLEX RECEPTACLE "TYPICAL ONLY".

Charging Station Detail
(Typical)

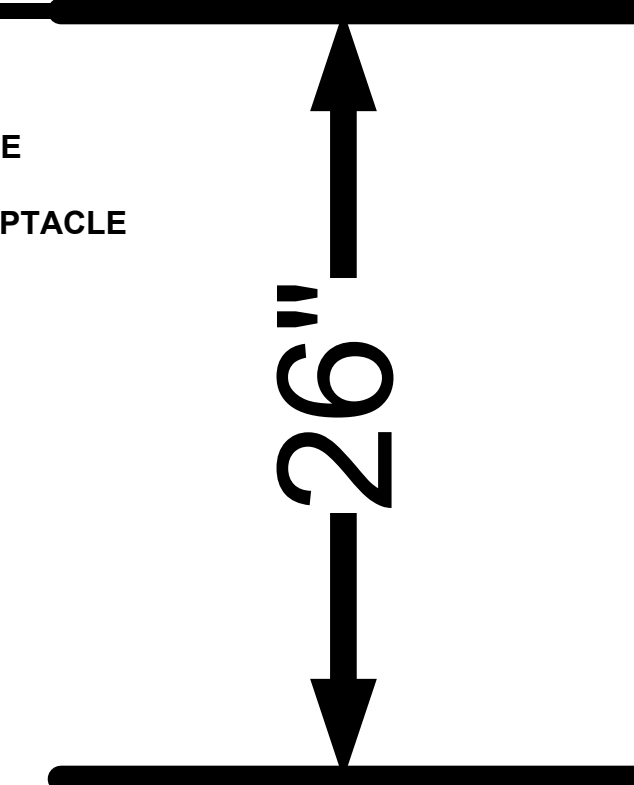

Finished Floor

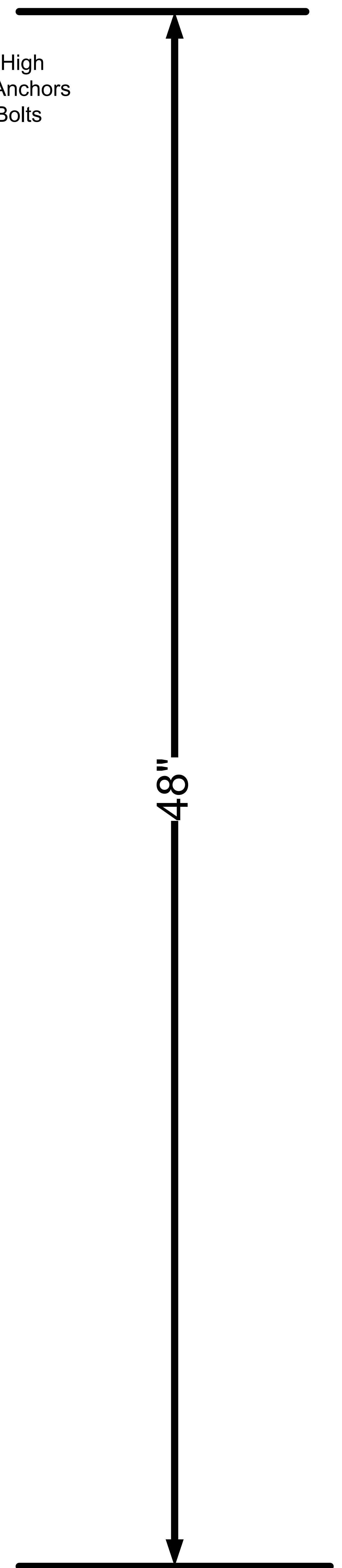

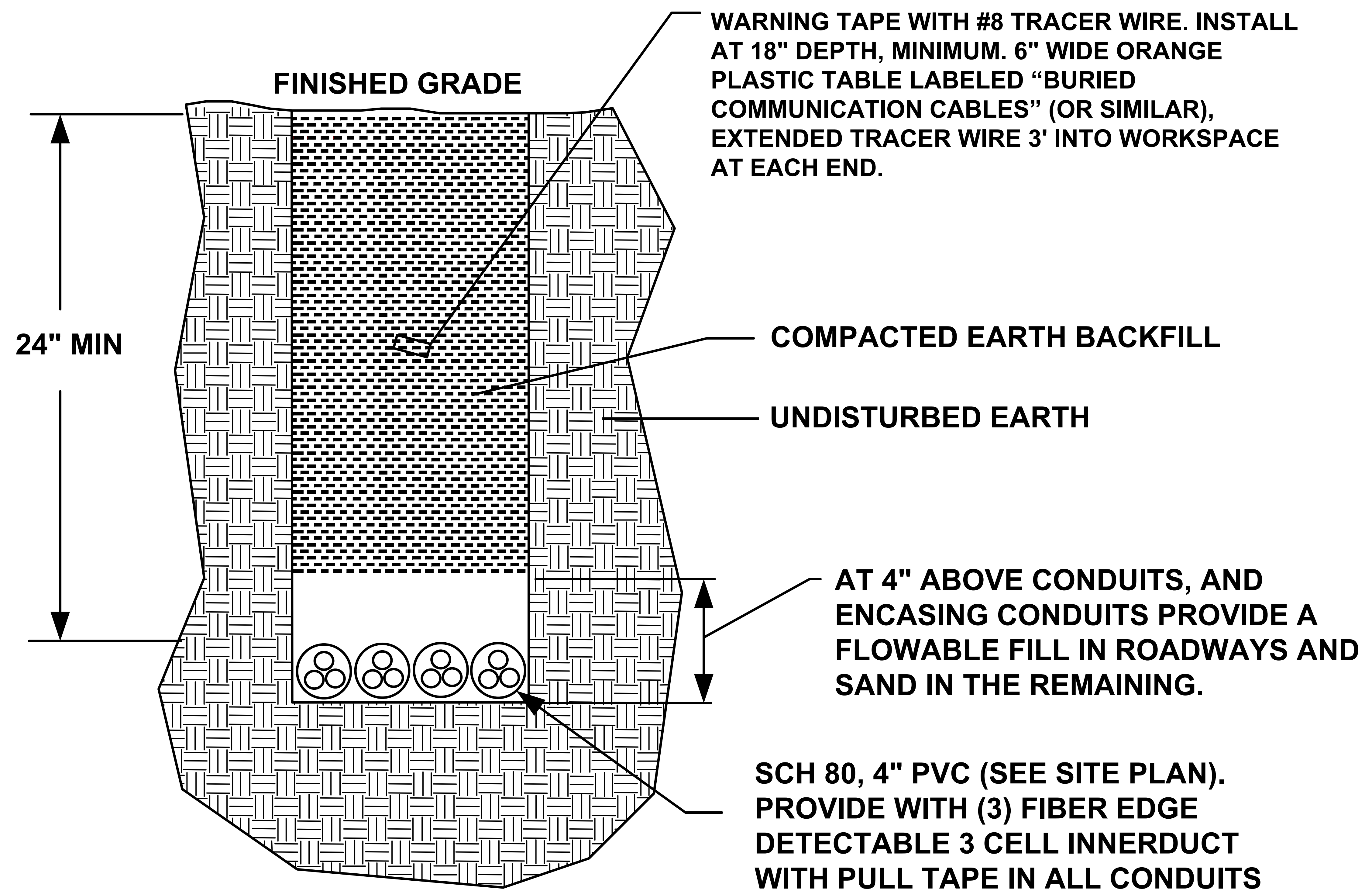

**CONDUIT TRENCHING / BORING DETAIL
(TYPICAL)**

(1) TECHNOLOGY ASSEMBLIES SHOWN SHALL BE MOUNTED ON CONTRACTOR PROVIDED AND INSTALLED:

DOUBLE GANG EMT WALL BOX 4"H X 4"D CONSISTING OF HUBBELL GANGABLE HBL985 WALL BOX (*OR SDOC APPROVED LIKE COMPONENT OF DIFFERING MANUFACTURER) INSTALLED WITH ONE (1) BARRIER (HUBBELL P/N# HBL989 *OR SDOC APPROVED LIKE COMPONENT OF DIFFERING MANUFACTURER) AS MANUFACTURER SPECIFIED LOW VOLTAGE PARTITION AT POWER RECEPTACLE LOCATION.

COUPLED TO EMT WALL BOX SHALL BE 1/4 INCH EMT CONDUIT (*OR SDOC APPROVED EQUIVALENT PATHWAY) INSTALLED VERTICALLY AND STUBBED OUT ABOVE CEILING REAMED AND BUSHED FOR CATEGORY 6A DATA OUTLET CABLING.

(2) HUBBELL I-STATON MODULAR FACEPLATE FRAME - 1-GANG DECORATOR 1-GANG I-STATON MODULAR FACEPLATE (HUBBELL P/N# IMFP1D10W - *OR SDOC APPROVED LIKE COMPONENT OF DIFFERING MANUFACTURER)

(3) TWO INSTALLED KEYSTONE MODULE FLAT, 2-PORT (HUBBELL P/N# IM2K10W - *OR SDOC APPROVED LIKE COMPONENT OF DIFFERING MANUFACTURER) INSTALLED IN EACH KEYSTONE MODULE SHALL BE TWO (2):

NEXTSPEED CATEGORY 6 JACKS (HUBBELL P/N# HXJ60W - *OR SDOC APPROVED LIKE COMPONENT OF DIFFERING MANUFACTURER) FOR A TOTAL OF FOUR (4) CATEGORY 6 JACKS WHEN COMPLETE.

(4) BLANK MODULE (HUBBELL P/N# IMB050W - *OR SDOC APPROVED SAME COMPONENT OF DIFFERING MANUFACTURER)

(5) DUPLEX GENERAL POWER RECEPTACLE 20A 125VAC (HUBBELL P/N# AVPS20BK *OR SDOC APPROVED LIKE COMPONENT OF DIFFERING MANUFACTURER) (EACH POWER RECEPTACLE SHALL BE TERMINATED AT LOCAL POWER PANEL AND SHALL BE LABELED ON THE RECEPTACLE WITH THE POWER PANEL NUMBER AND CIRCUIT BREAKER NUMBER AT ALL LOCATIONS.) (ALL CABLING AND COMPONENTS CONTRACTOR PROVIDED AND INSTALLED, TERMINATED, TESTED, LABELED ALL LOCATIONS)

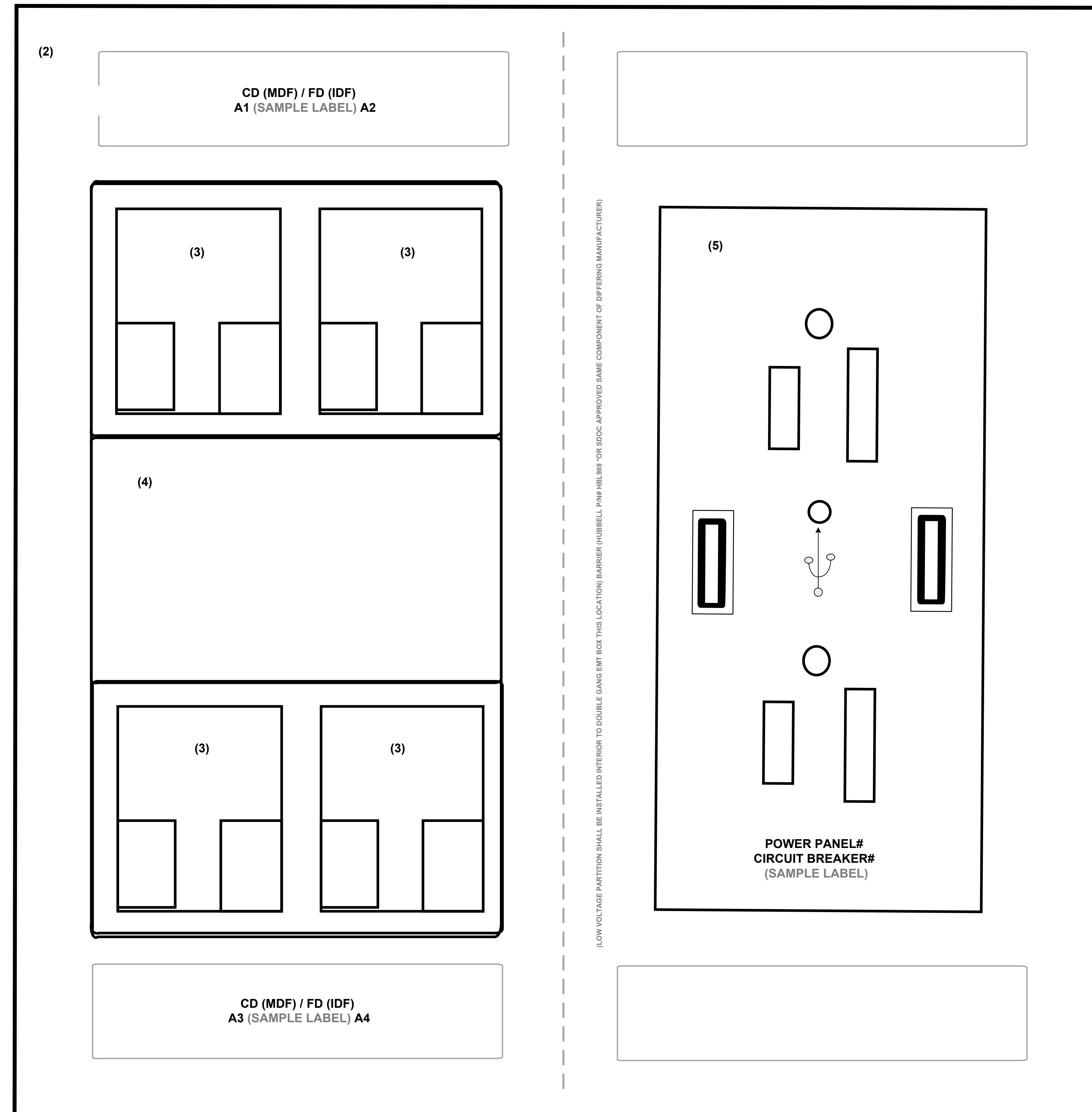

ONE (1/4) INCH EMT CONDUIT OR OTHER SDOC APPROVED PATHWAY VERTICAL TO SIX (6) INCHES ABOVE FINISHED CEILING REAMED AND BUSHED ALL LOCATIONS

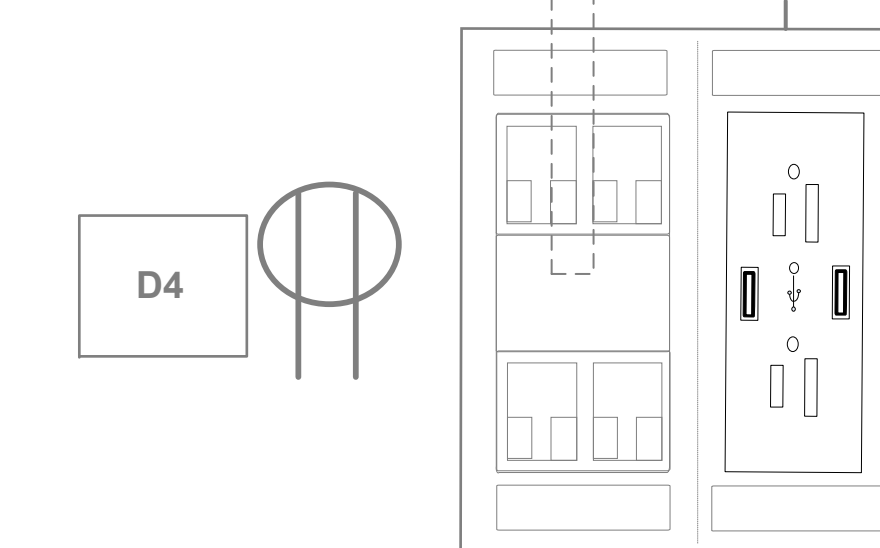

ELECTRICAL "MC" OR EMT CONDUIT VERTICAL TO ABOVE CEILING TO ELECTRICAL PANEL ALL LOCATIONS

(1)

**D4 DATA OUTLET DETAIL
 INSTALLED AT ALL DESIGNATED DATA OUTLET WALL LOCATIONS
 AT EIGHTEEN (18) INCHES TO THE CENTER OF EACH BOX ABOVE FINISHED FLOOR.**

(DETAIL NOT TO SCALE)

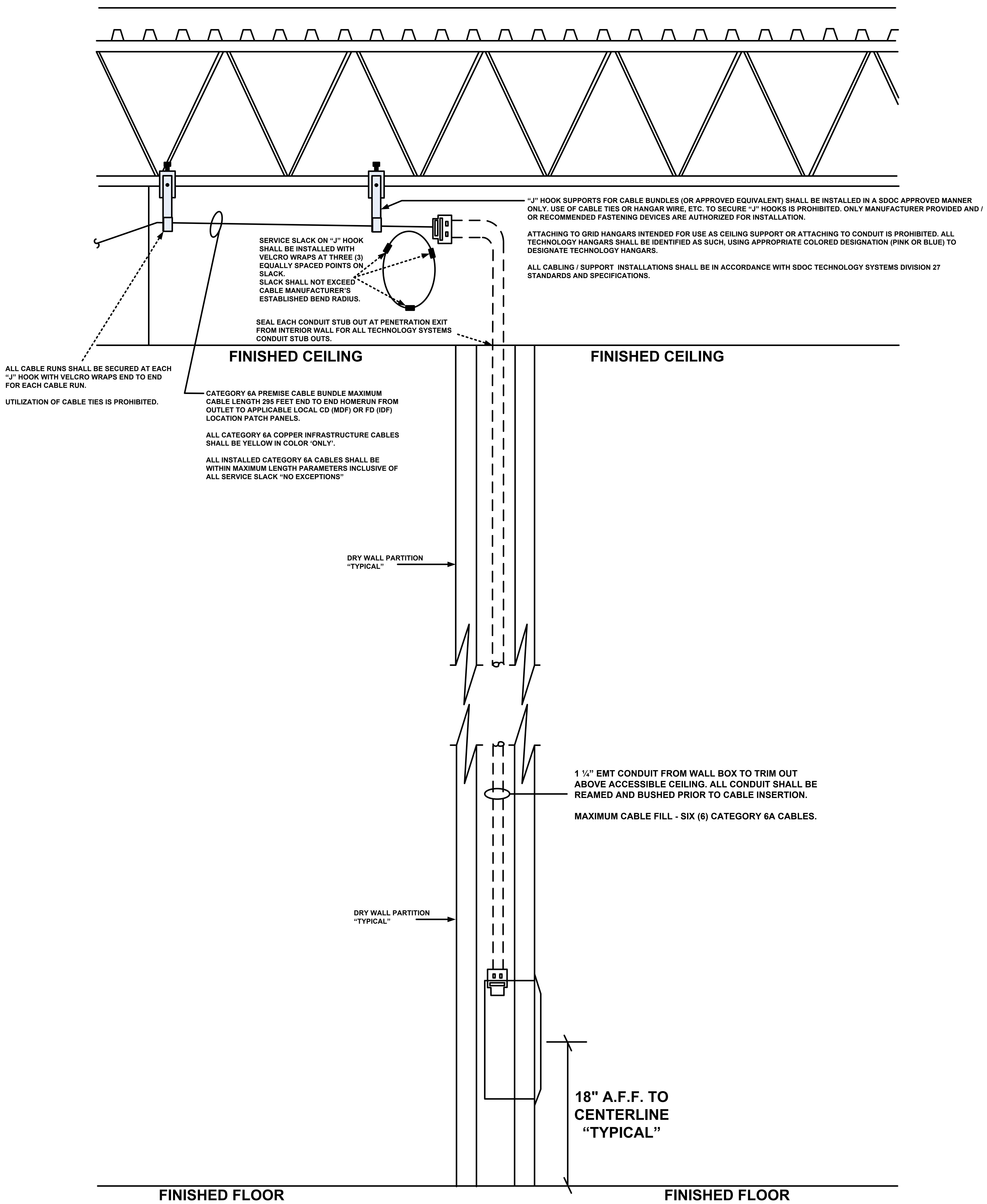

TYPICAL WALL MOUNTED TECHNOLOGY COMMUNICATIONS DATA OUTLET

(DETAIL NOT TO SCALE)

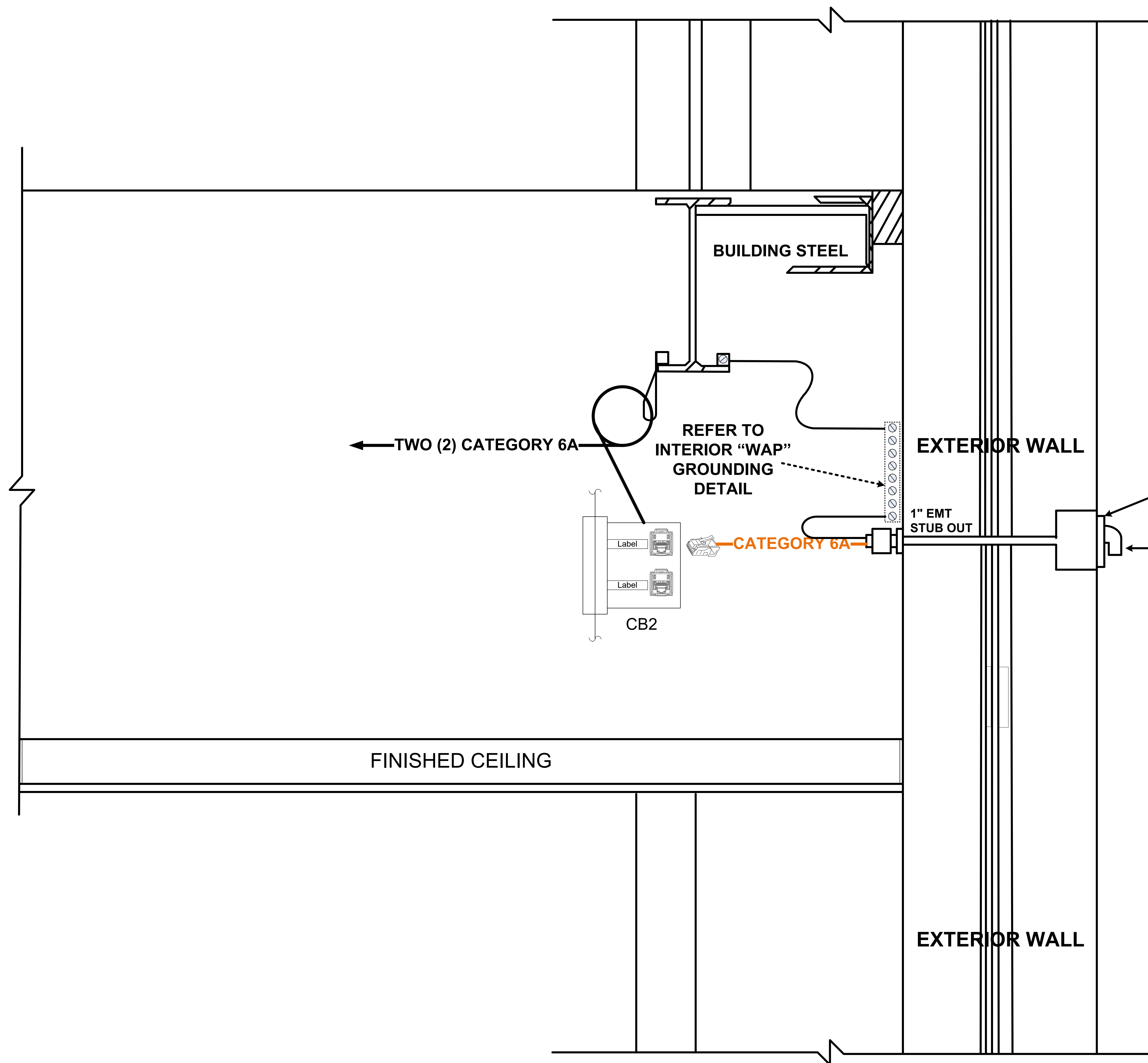

EXTERIOR BOXES SHALL BE MOUNTED AT A MINIMUM STANDARD HEIGHT OF TEN (10) FEET ABOVE FINISHED GRADE. STANDARD HEIGHT AND LOCATION SHALL BE ADJUSTED BY ARCHITECT AND ENGINEER TO AVOID STRUCTURAL IMPEDIMENTS SUCH AS DOWN SPOUTS, CANOPIES, BUILDING STEEL AND OTHER UNFORESEEN OBSTRUCTIONS. ARCHITECT AND ENGINEER SHALL ALSO POTENTIALLY EXERCISE OPTION TO ADJUST HEIGHT AND LOCATION TO COMPLY WITH NEW CONSTRUCTION REGARDING AESTHETICS' OF BUILDING IN CONSTRUCTION.

FOR ALL NEW CONSTRUCTED WALL LOCATIONS TYPICAL DOUBLE GANG BACK BOX WITH EXTENSION RING SHALL BE INSTALLED WITH SINGLE GANG MUD RING AND STAINLESS STEEL SINGLE GANG COVER WITH WATERTIGHT GASKET FLUSH MOUNT TO EXTERIOR SURFACE. LIQUID TIGHT FLEXIBLE CONDUIT SHALL BE INSTALLED TO ACCOMMODATE PATCH CORD TO RJ45 JACK LOCATED IN ALL EXTERIOR "WAP" LOCATIONS. ATTACH GROUNDING CABLING TO LIQUID TIGHT FLEXIBLE CONDUIT USING APPROVED SECURING HARDWARE.

SEAL INTERIOR AND EXTERIOR OF PENETRATION LOCATIONS 360 DEGREES AROUND INSTALLED CONDUIT USING UL APPROVED SEALANTS PER APPLICABLE CODES.

**DETAIL WIRELESS ACCESS POINT BUILDOUT
EXTERIOR FLUSH MOUNTED
APPLICATION**

NOT TO SCALE
FOR REFERENCE ONLY

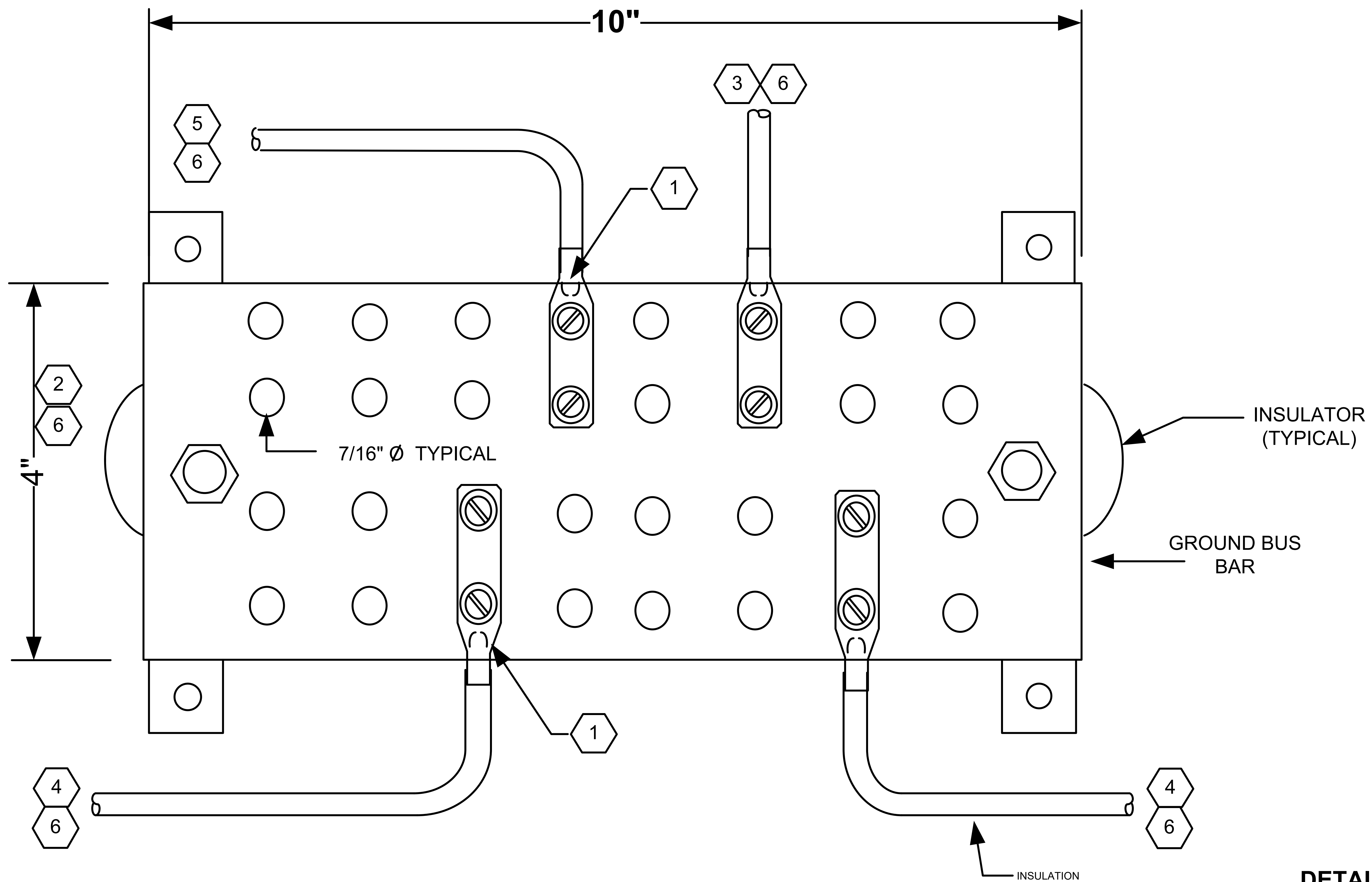

**GROUND BAR DETAIL
- TYPICAL -**

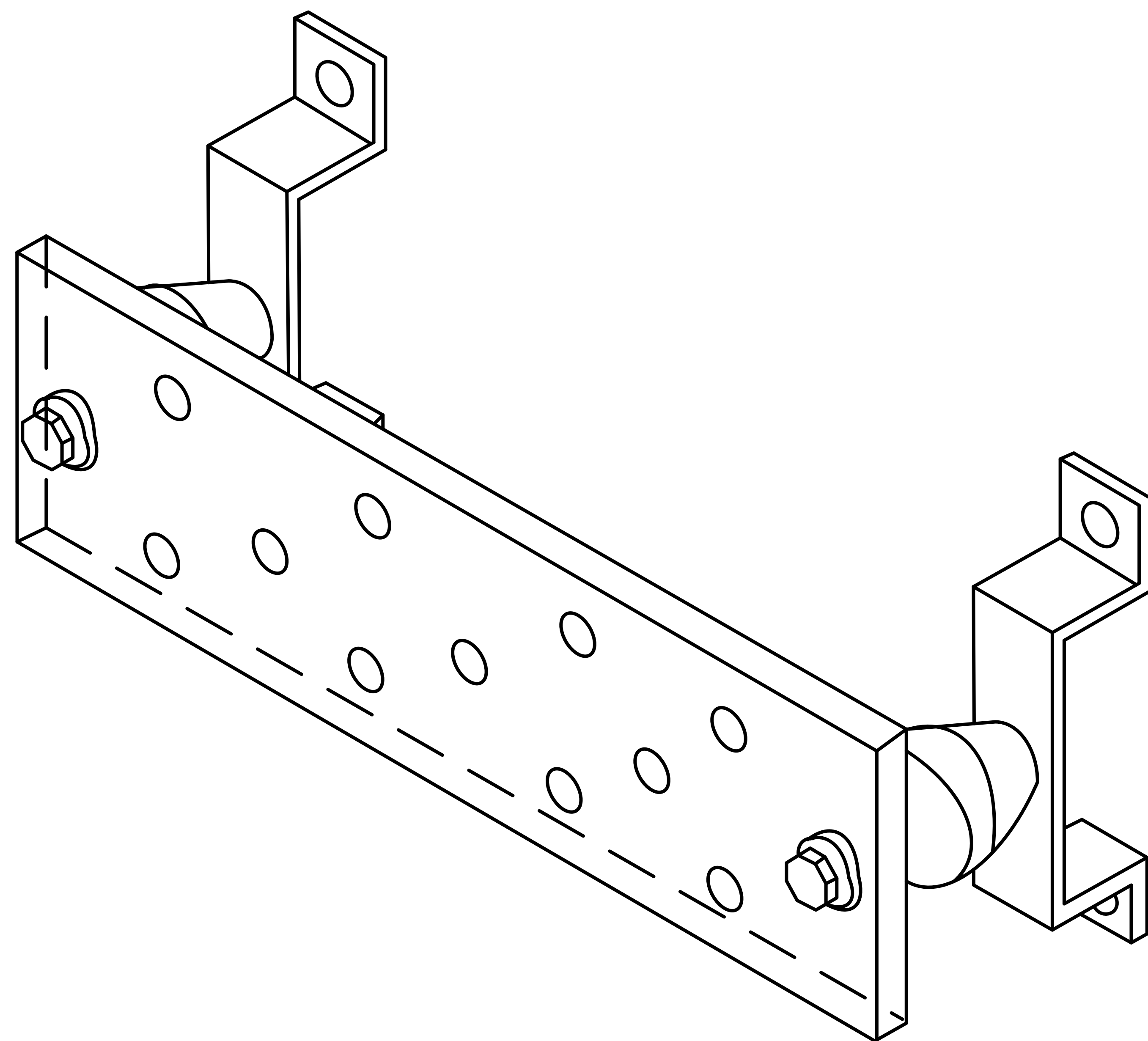

DETAIL KEYNOTES (X)

- 1 IRREVERSIBLE CRIMP STYLE LUG – DOUBLE BOLT FOR ALL BUS BAR CONNECTIONS - TYPICAL
- 2 #6 AWG GREEN INSULATED COPPER GROUND BETWEEN EQUIPMENT AND BUS BAR
- 3 MINIMUM #6 AWG GREEN INSULATED COPPER GROUND BETWEEN BUILDING STEEL AND BUS BAR REQUIRED SIZE TO BE CALCULATED BY TECHNOLOGY DESIGN PROFESSIONAL
- 4 MINIMUM #4 AWG GREEN INSULATED COPPER GROUND BETWEEN POWER PANEL AND BUS BAR REQUIRED SIZE TO BE CALCULATED BY TECHNOLOGY DESIGN PROFESSIONAL
- 5 MINIMUM #4 AWG GREEN INSULATED COPPER GROUND BETWEEN BUS BARS REQUIRED SIZE TO BE CALCULATED BY TECHNOLOGY DESIGN PROFESSIONAL
- 6 ALL CABLING TYPEWRITTEN LABELS DENOTING FAR END TERMINATION POINT

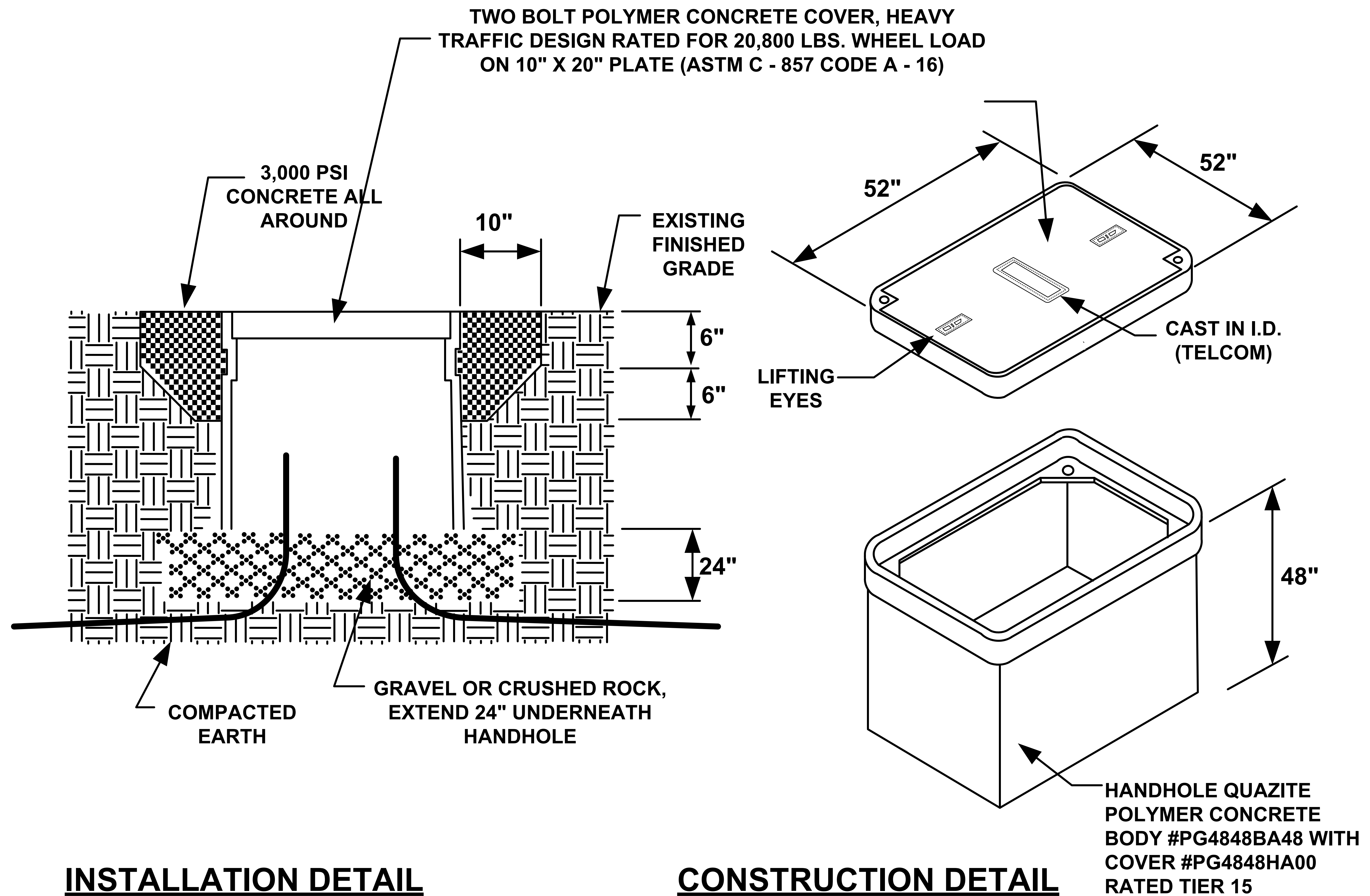

CONSTRUCTION HANDHOLE NOTES:

1. HANDHOLE WITH COVER (LOGO = TELECOM) SHALL BE QUAZITE OR EQUAL. INSTALL IN ACCORDANCE WITH THE MANUFACTURER'S PRINTED INSTRUCTIONS AND THESE REQUIREMENTS.
2. TERMINATE CONDUITS ENTERING HANDHOLE WITH END BELL (CARLON E997). CONSTRUCT CONDUIT RISE TO ENTER BOX FROM SIDE WITH 22 - 1/2" SWEEP ELBOWS.

TYPICAL HANDHOLE DETAIL

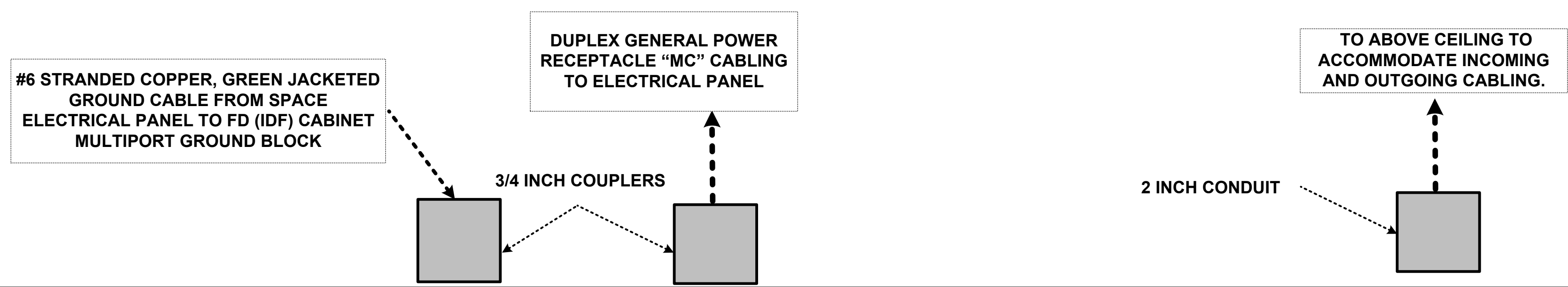

(1) INDICATES AN SDOC APPROVED METHOD OF CABLE SUPPORT FOR SERVICE SLACK PROVIDED AND INSTALLED AT ALL SDOC REQUIRED LOCATIONS

- TECHNOLOGY CONTRACTOR PROVIDED IDF CABINET PATCH PANEL FIBER OPTIC "SC" KEYSTONE ADAPTERS PART NUMBER NOMENCLATURE:
- CONTRACTOR SHALL PROVIDE AND INSTALL HUBBELL SC SIMPLEX KEYSTONE ADAPTERS P/N# SFSCSAQBK (*OR SDOC APPROVED LIKE COMPONENT OF DIFFERING MANUFACTURER)
- FIBER OPTIC CABLE AND ALL COMPONENTS TECHNOLOGY CONTRACTOR PROVIDED, INSTALLED TERMINATED, TESTED, AND LABELED, SUPPORTED SERVICE SLACK FOR HOMERUN 6 STRAND SINGLE MODE LOOSE TUBE FIBER OPTIC CABLE.
- ALL TERMINATIONS SHALL BE FUSION SPLICED - ALL SC FIBER OPTIC CONNECTIONS SHALL BE PRE-POLISHED, FACTORY MANUFACTURED.

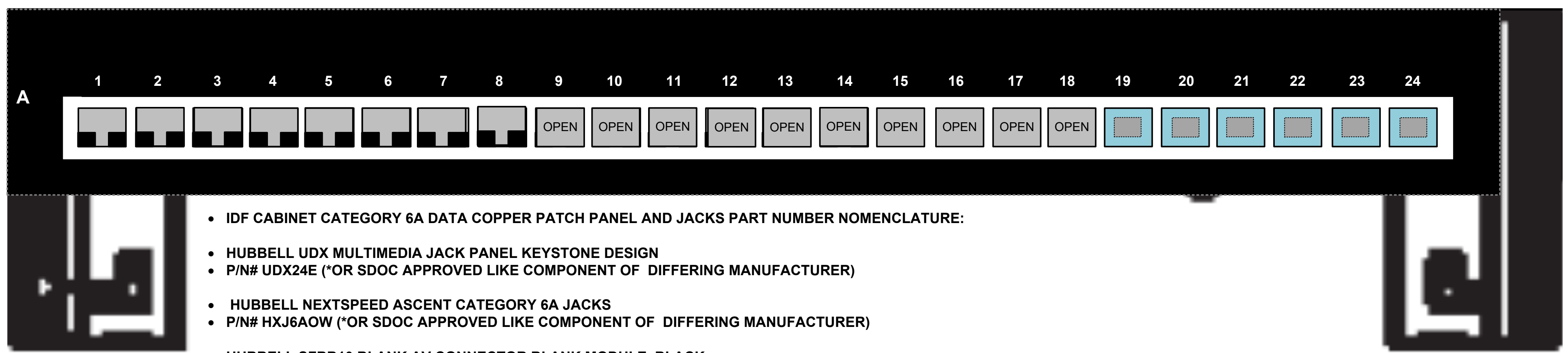

- IDF CABINET CATEGORY 6A DATA COPPER PATCH PANEL AND JACKS PART NUMBER NOMENCLATURE:
- HUBBELL UDX MULTIMEDIA JACK PANEL KEYSTONE DESIGN
- P/N# UDX24E (*OR SDOC APPROVED LIKE COMPONENT OF DIFFERING MANUFACTURER)
- HUBBELL NEXTSPEED ASCENT CATEGORY 6A JACKS
- P/N# HXJ6AOW (*OR SDOC APPROVED LIKE COMPONENT OF DIFFERING MANUFACTURER)
- HUBBELL SFBB10 BLANK AV CONNECTOR BLANK MODULE, BLACK,
- INSERT UNUSED JACK LOCATIONS (*OR SDOC APPROVED LIKE COMPONENT OF DIFFERING MANUFACTURER)
- APC BE600M1 600VA 120V APC Back-UPS CONTRACTOR PROVIDED BATTERY UPS BACK UP
- (*OR SDOC APPROVED LIKE COMPONENT OF DIFFERING MANUFACTURER)
- ALL ITEMS CONTRACTOR PROVIDED, INSTALLED TERMINATED TESTED AND LABELED, SUPPORTED SERVICE SLACK
- FOR HOMERUN CATEGORY 6A COPPER DATA CABLES IN IDF CABINET TO ULTIMATE DATA OUTLET DESTINATION AT ALL DEVICE LOCATIONS.

HUBBELL REBox RE2 WALL MOUNT CABINET

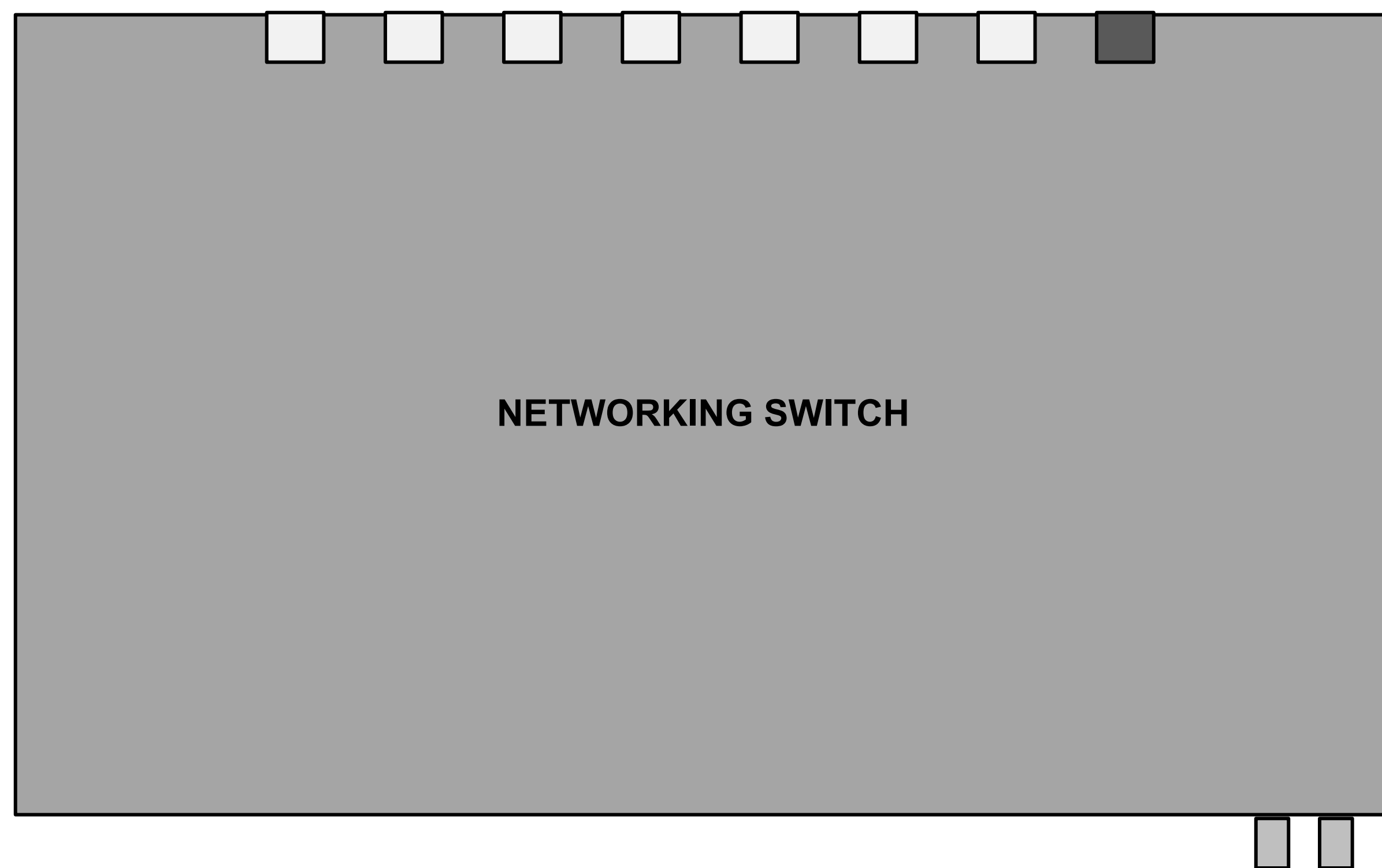

NOTE: UTILIZE MANUFACTURED KNOCKOUTS PROVIDED IN CABINET CHASSIS FOR INSTALLATION OF SLEEVING CONDUITS AND FOR COMPONENTS SUCH AS FAN KIT, WHERE AVAILABLE. NEW PENETRATIONS SHALL ONLY BE CUT INTO THE CABINET WITH PRIOR SDOC TECHNOLOGY CONSTRUCTION PROJECT MANAGER APPROVAL.

CABINET GROUND CONNECTION AND GROUND LUG

CHATSWORTH FANKIT
CPI 13051-001 4U-6U

DUPLEX GENERAL POWER RECEPTACLE
(INSTALLED FACE UP)

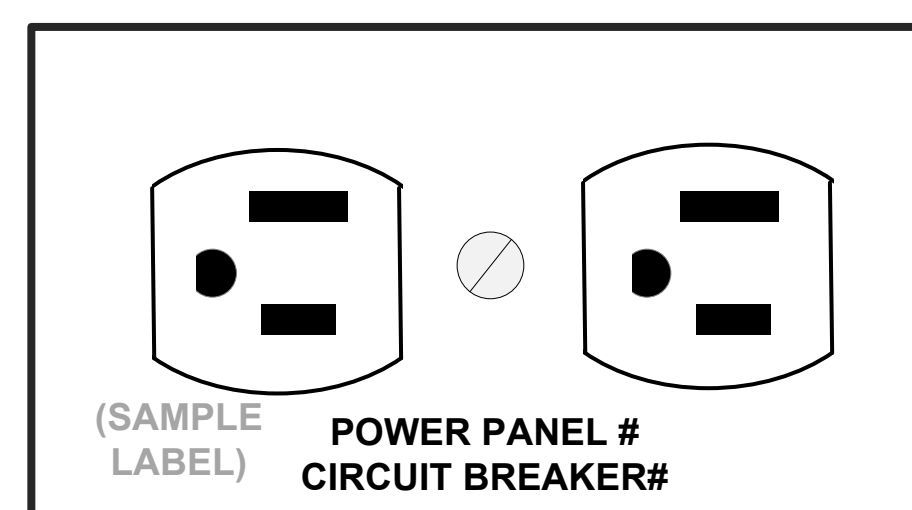

TYPICAL FD (IDF) CABINET INSTALLATION CONFIGURATION

IDF (FD) RACK CONFIGURATION TYPICAL

(DETAIL NOT TO SCALE)

RACK BUILD OUT AS VIEWED FROM THE FRONT

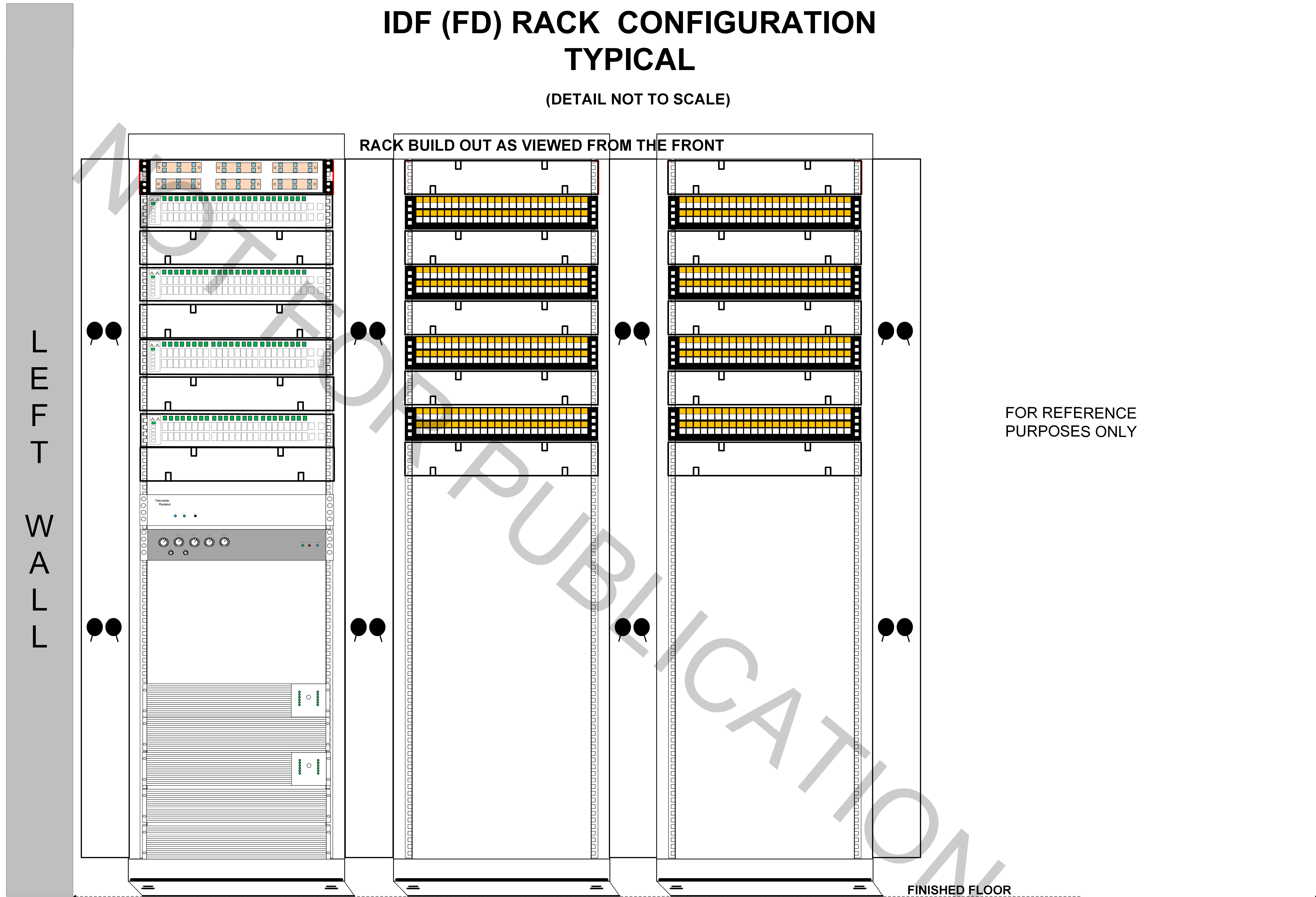

FOR REFERENCE
PURPOSES ONLY

L
E
F
T

W
A
L
L

FOR REFERENCE
PURPOSES ONLY

FINISHED FLOOR

FOR REFERENCE
PURPOSES ONLY

Chatsworth Horizontal Cable Manager
P/N 30330-719 - Contractor provided / Quantities Site
Specific

Fiber optic Campus Box (LIU) - Contractor Provided /
Installed

Network Switch Components - Owner Provided / Installed

TCU Headend Equipment - Provided / Installed Rauland
Borg 14 U above UPS U.O.N.

APC 2200 UPS / APC 72V Battery pack - Owner Provided /
Installed

APC 5K UPS / APC 192V Battery pack - Owner Provided /
Installed

NEMA L6 - 30R receptacle located behind rack at 80"
A.F.F.U.O.N. - Contractor Provided / Installed

NEMA 5 - 20R quad receptacle located behind rack at 80"
A.F.F.U.O.N. - Contractor Provided / Installed

Rack units 1 - 14 to remain empty (free of patch panels /
LIU (Bottom up))

Standard Rack - 7 feet tall (45U) / 19 inches wide - Black -
Contractor Provided / Installed

Chatsworth Horizontal Cable Manager
P/N 30330-719 - Contractor provided / Quantities Site
Specific

Patch Panel Components / Hardware - Contractor
Provided / Installed

Rack units 1-14 to remain empty (free of patch panels / LIU
(Bottom up))

Standard Rack - 7 feet tall (45U) / 19 inches wide - Black -
Contractor Provided / Installed

Chatsworth Horizontal Cable Manager
P/N 30330-719 - Contractor provided / Quantities Site
Specific

Patch Panel Components / Hardware - Contractor
Provided / Installed

NEMA 5 - 20R quad receptacle located behind rack at 80"
A.F.F.U.O.N. - Contractor Provided / Installed

Rack units 1-14 to remain empty (free of patch panels / LIU
(Bottom up))

Standard Rack - 7 feet tall (45U) / 19 inches wide - Black -
Contractor Provided / Installed

FOR REFERENCE
PURPOSES ONLY

ONE (1) INCH EMT CONDUIT COUPLED TO BOXES MOUNTED ON HUBBELL FPTV ENCLOSURE

ELECTRICAL "MC" OR EMT CONDUIT VERTICAL ELECTRICAL POWER PANEL FEEDING

TWO (2) ONE INCH EMT CONDUIT COUPLED TO BOX MOUNTED ON HUBBELL FPTV ENCLOSURE STUBBED OUT ABOVE CEILING FOR "AE" AUDIO ENHANCEMENT FIELD END SPEAKER CABLING AND DATA OUTLET CABLING

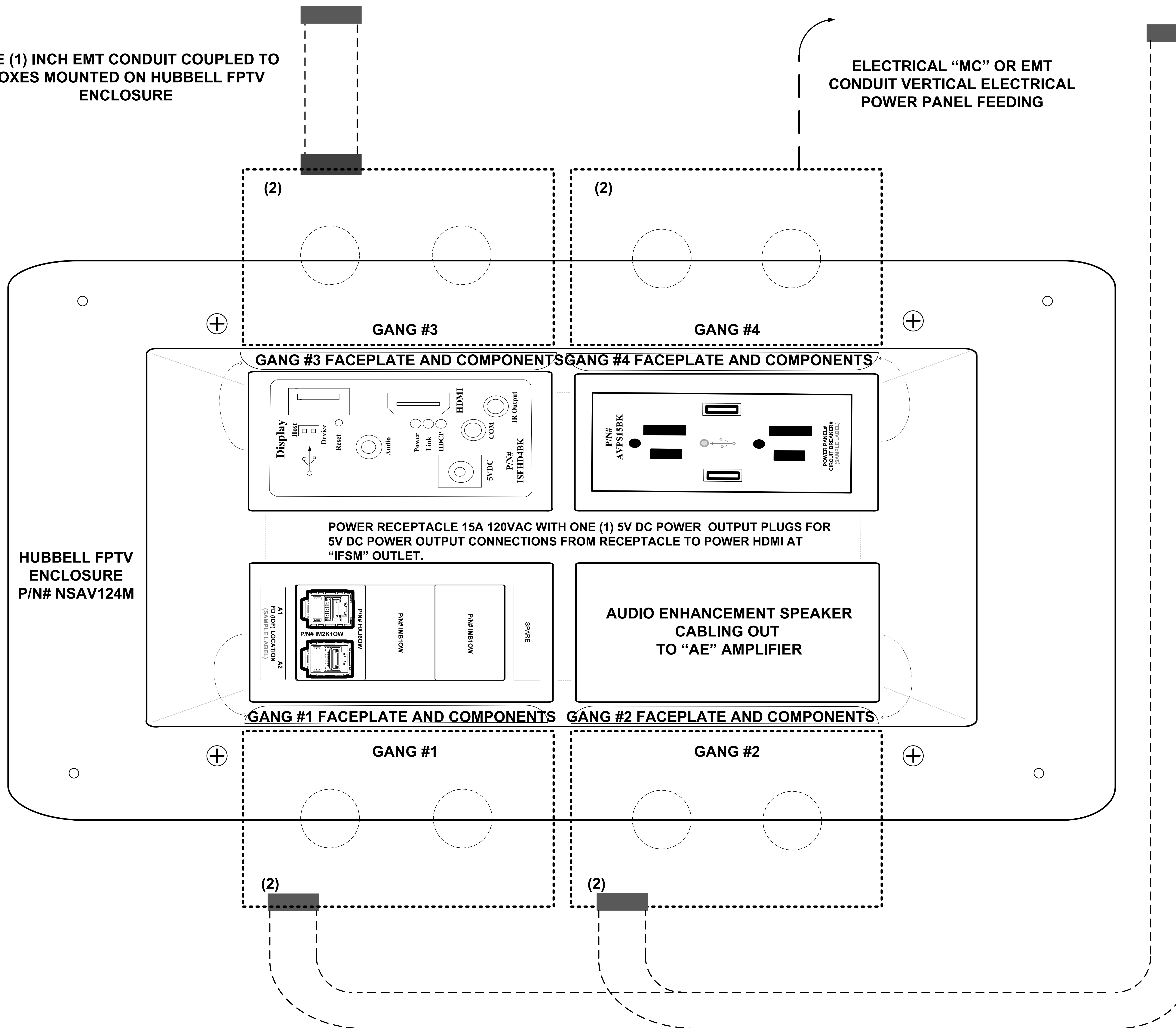

POWER RECEPTACLE 15A 120VAC WITH ONE (1) 5V DC POWER OUTPUT PLUGS FOR 5V DC POWER OUTPUT CONNECTIONS FROM RECEPTACLE TO POWER HDMI AT "IFSM" OUTLET.

AUDIO ENHANCEMENT SPEAKER CABLING OUT TO "AE" AMPLIFIER

(2) SINGLE GANG EMT 3"L X 2"W X 2.75"D BOX RACO 565 (OR SDOC APPROVED LIKE COMPONENT) EACH BOX SHALL FASTEN TO HUBBELL FPTV CONNECTION ENCLOSURE AND CONTAIN 1" KNOCKOUTS FOR EMT STUB OUTS TO ABOVE CEILING.

SYMBOL -



INTERACTIVE FLAT SCREEN MONITOR "IFSM" OUTLET INSTALLATION: IFSM ENCLOSURE SHALL BE INSTALLED AT A HEIGHT WHEREAS ENCLOSURE IS FULLY CONCEALED WHEN MX-275 IS AT HIGHEST POSITION BUT IS FULLY EXPOSED AT LOWEST POSITION

ENCLOSURE SHALL BE INSTALLED HORIZONTAL AT THIRTEEN (13) INCHES OFFSET FROM CENTERLINE OF WALL AS ESTABLISHED BY PROJECT ARCHITECT AND ENGINEER (DETAIL NOT TO SCALE)

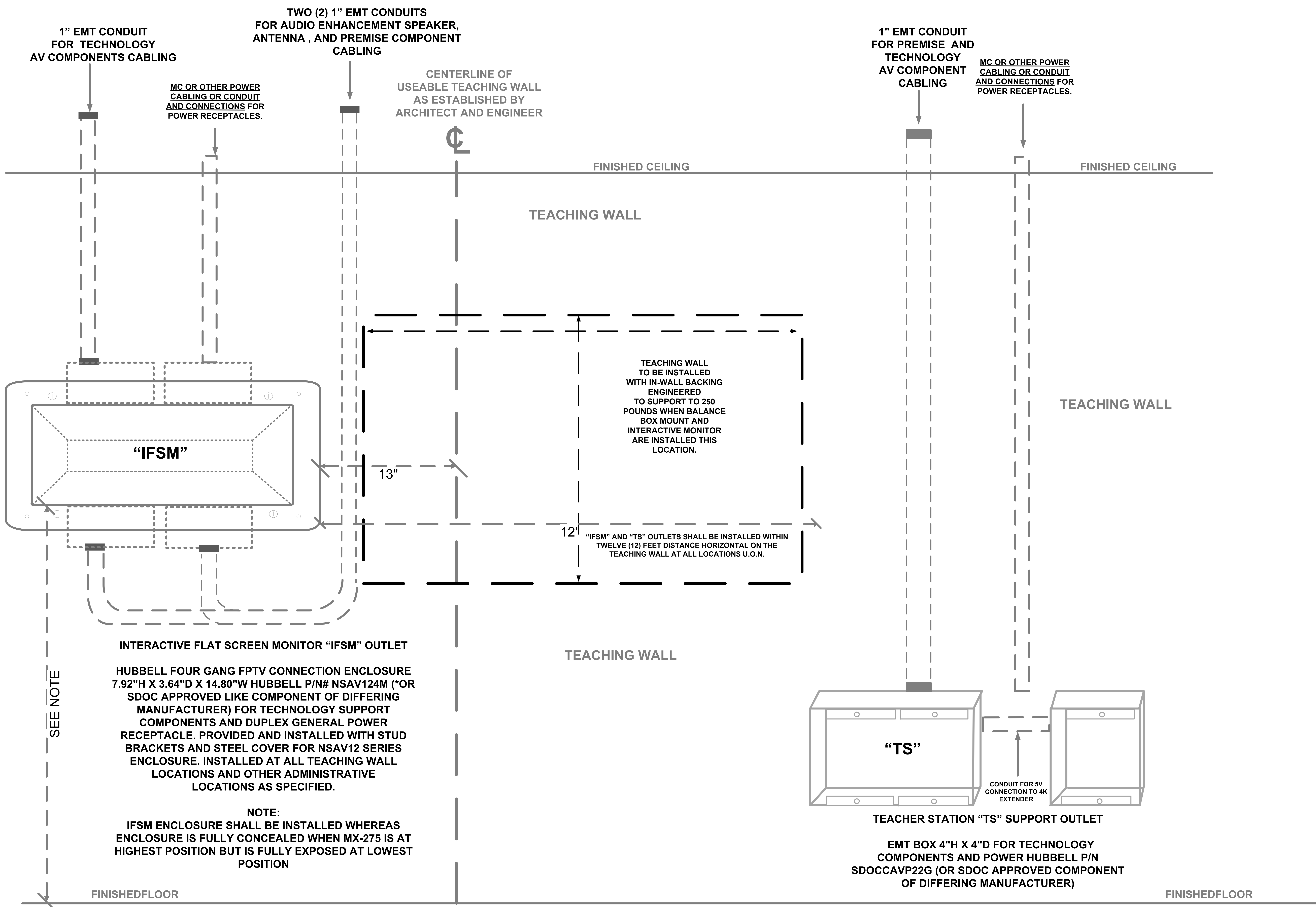

CLASSROOM TEACHING WALL AV OUTLET BOX, CONDUIT AND POWER RECEPTACLE IN WALL ROUGH-IN DETAIL

DETAIL NOT TO SCALE

NOTE: THIS DETAIL IS "TYPICAL ONLY" FOR REFERENCE REGARDING CONDUIT AND BOX SIZES, HEIGHT AND WIDTH SPECIFICS, QUANTITIES AND OUTLET BOX BUILD OUT SEQUENCE ONLY.

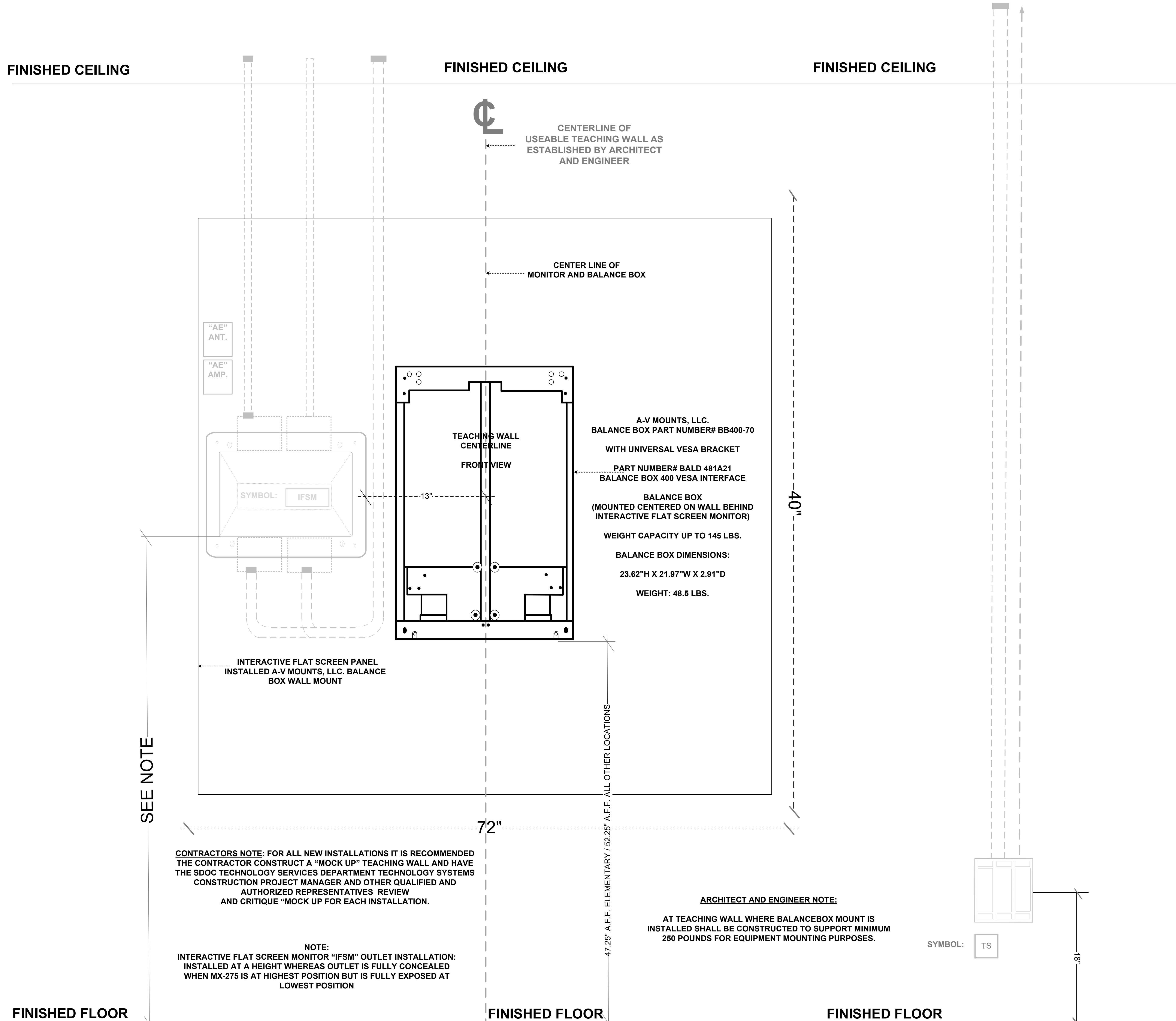

SEE NOTE

CONTRACTORS NOTE: FOR ALL NEW INSTALLATIONS IT IS RECOMMENDED THE CONTRACTOR CONSTRUCT A "MOCK UP" TEACHING WALL AND HAVE THE SDOC TECHNOLOGY SERVICES DEPARTMENT TECHNOLOGY SYSTEMS CONSTRUCTION PROJECT MANAGER AND OTHER QUALIFIED AND AUTHORIZED REPRESENTATIVES REVIEW AND CRITIQUE "MOCK UP" FOR EACH INSTALLATION.

NOTE:
INTERACTIVE FLAT SCREEN MONITOR "IFSM" OUTLET INSTALLATION: INSTALLED AT A HEIGHT WHEREAS OUTLET IS FULLY CONCEALED WHEN MX-275 IS AT HIGHEST POSITION BUT IS FULLY EXPOSED AT LOWEST POSITION

ARCHITECT AND ENGINEER NOTE:
AT TEACHING WALL WHERE BALANCEBOX MOUNT IS INSTALLED SHALL BE CONSTRUCTED TO SUPPORT MINIMUM 250 POUNDS FOR EQUIPMENT MOUNTING PURPOSES.

STANDARD CLASSROOM TEACHING WALL "IFSM" TECHNOLOGY INSTALLATION DETAIL "TYPICAL"

(DETAIL NOT TO SCALE)

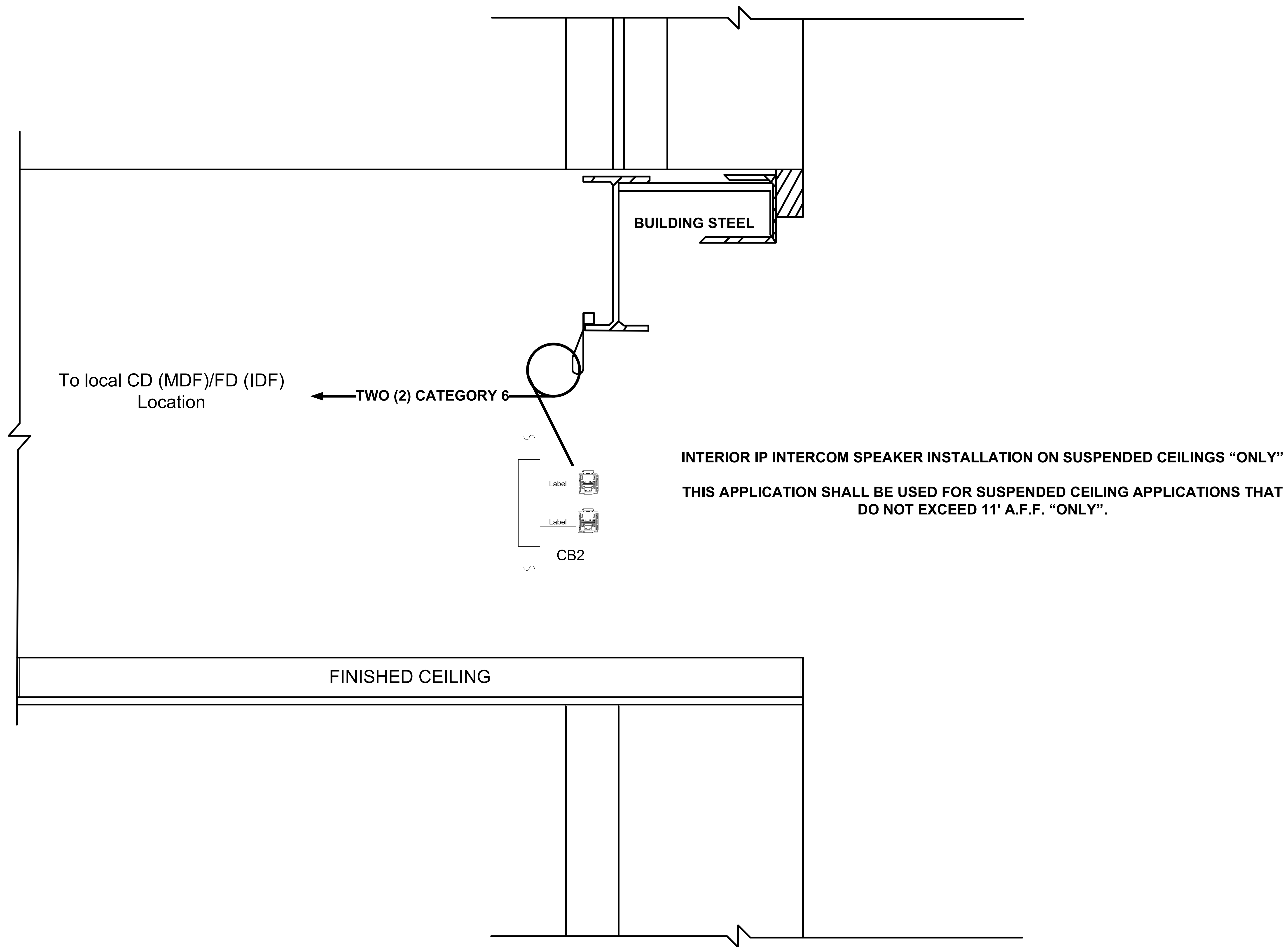

TYPICAL SUSPENDED CEILING IP INTERCOM
SPEAKER INSTALLATION DETAIL

NOT TO SCALE
FOR REFERENCE ONLY

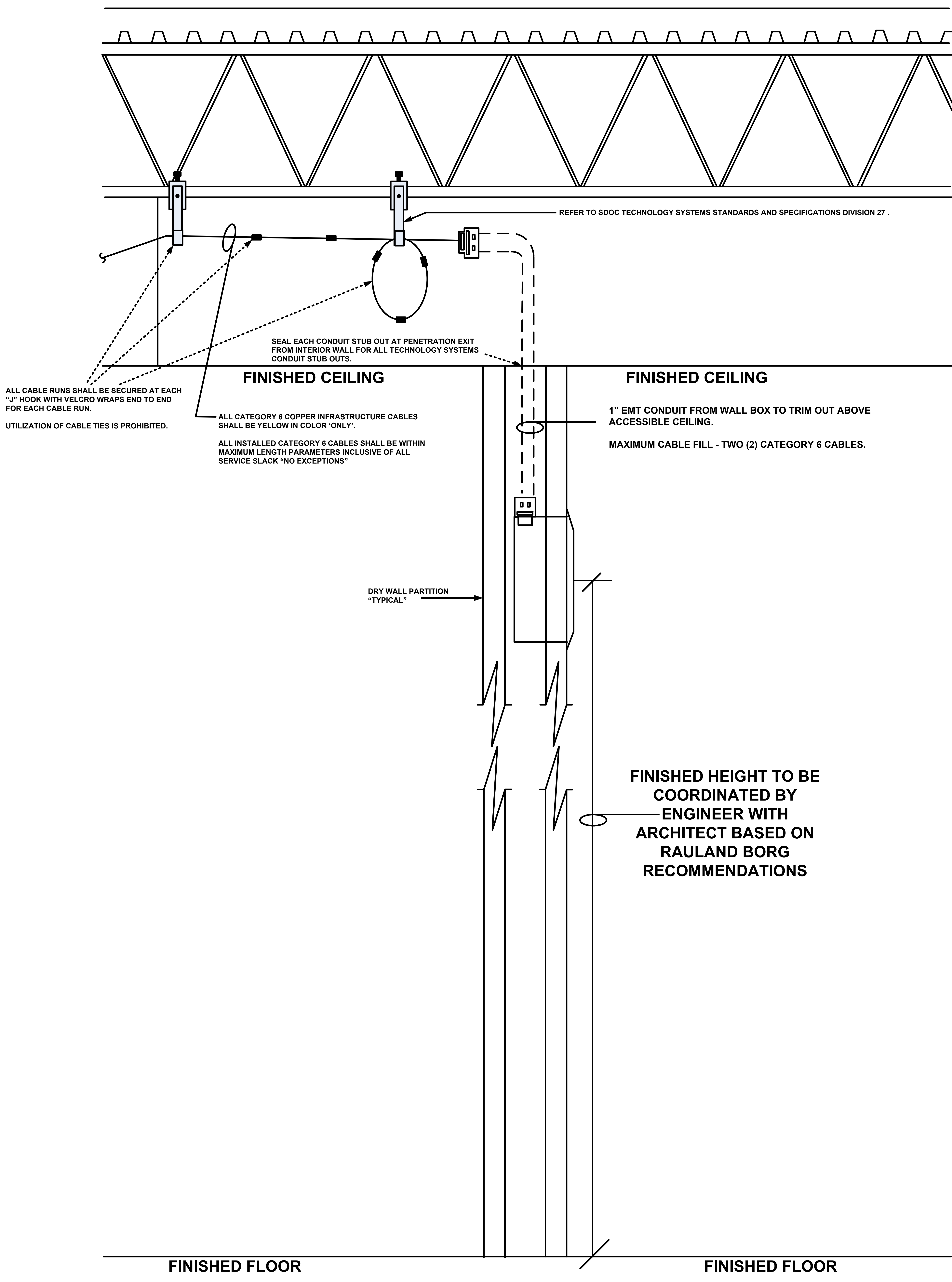

TYPICAL WALL MOUNTED INTERCOM SPEAKER / MESSAGE BOARD OUTLET

(DETAIL NOT TO SCALE)

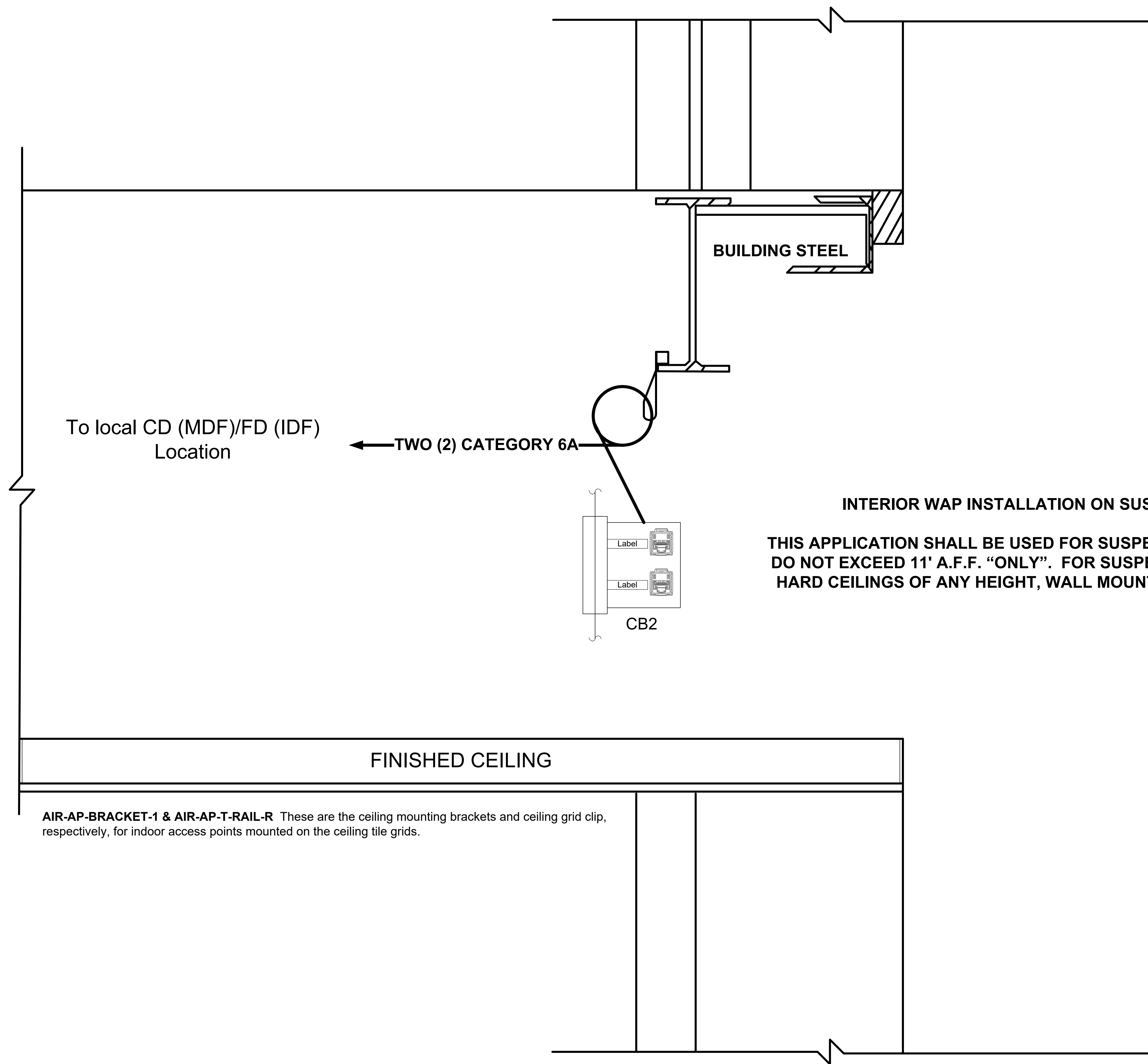

AIR-AP-BRACKET-1 & AIR-AP-T-RAIL-R These are the ceiling mounting brackets and ceiling grid clip, respectively, for indoor access points mounted on the ceiling tile grids.

**TYPICAL SUSPENDED CEILING WAP INSTALLATION
DETAIL FOR SUSPENDED CEILINGS UNDER 11'
A.F.F.**

NOT TO SCALE
FOR REFERENCE ONLY

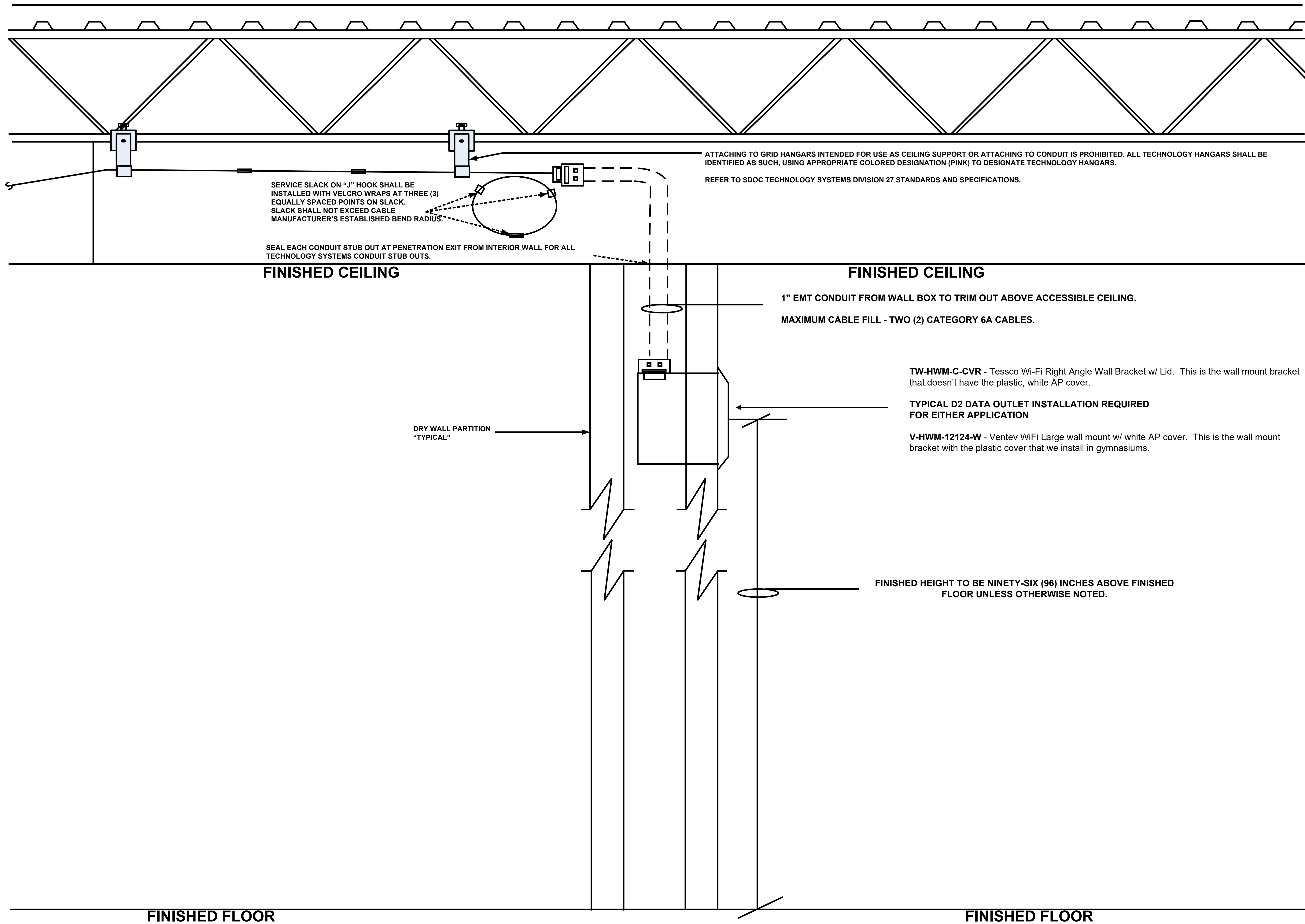

TYPICAL WIRELESS ACCESS POINT (WALL MOUNTED APPLICATION)

(DETAIL NOT TO SCALE)

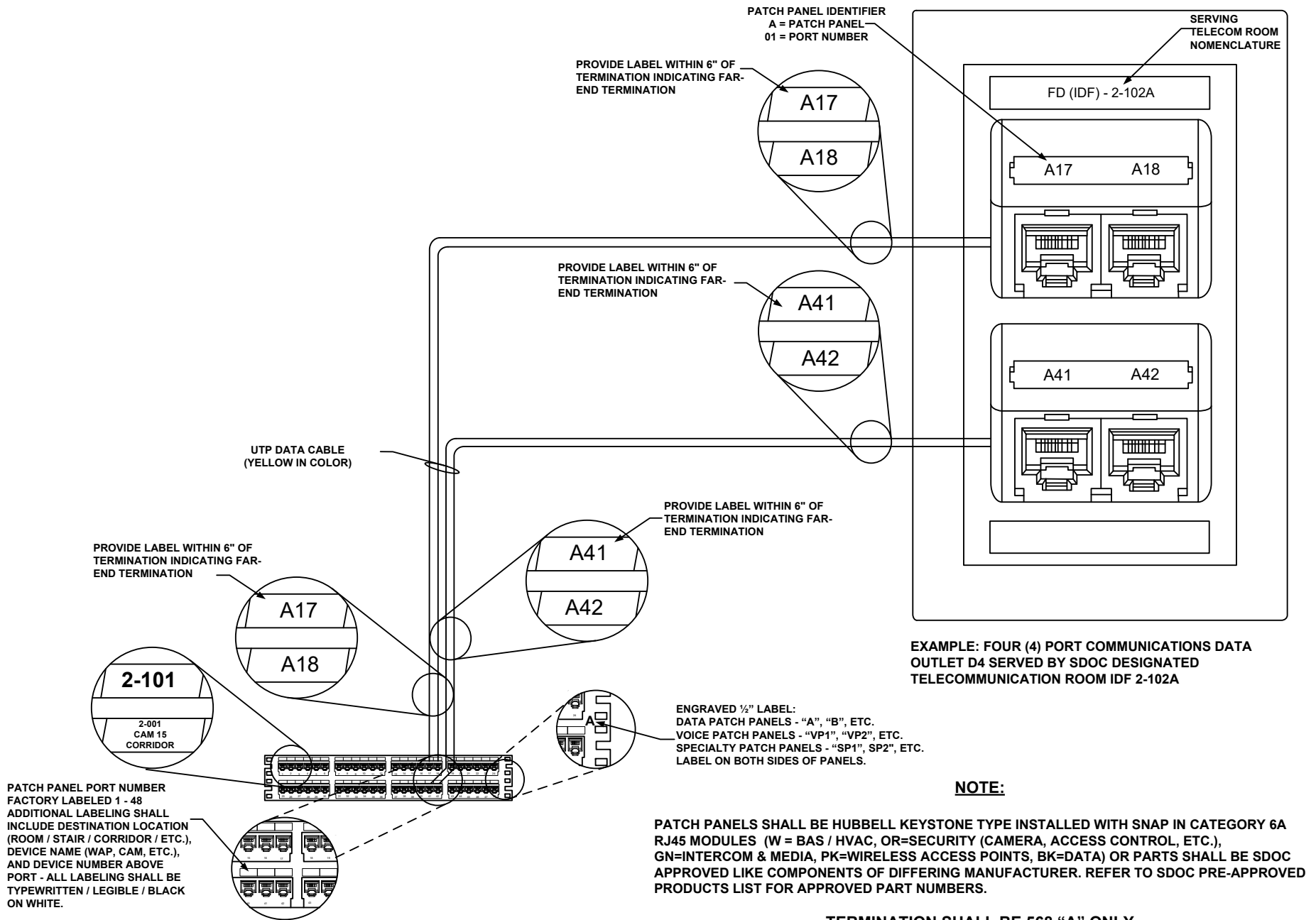

COMMUNICATIONS DATA PATCH PANEL AND DATA OUTLET WIRING DETAIL "TYPICAL"

NOT TO SCALE

FOR REFERENCE PURPOSES ONLY

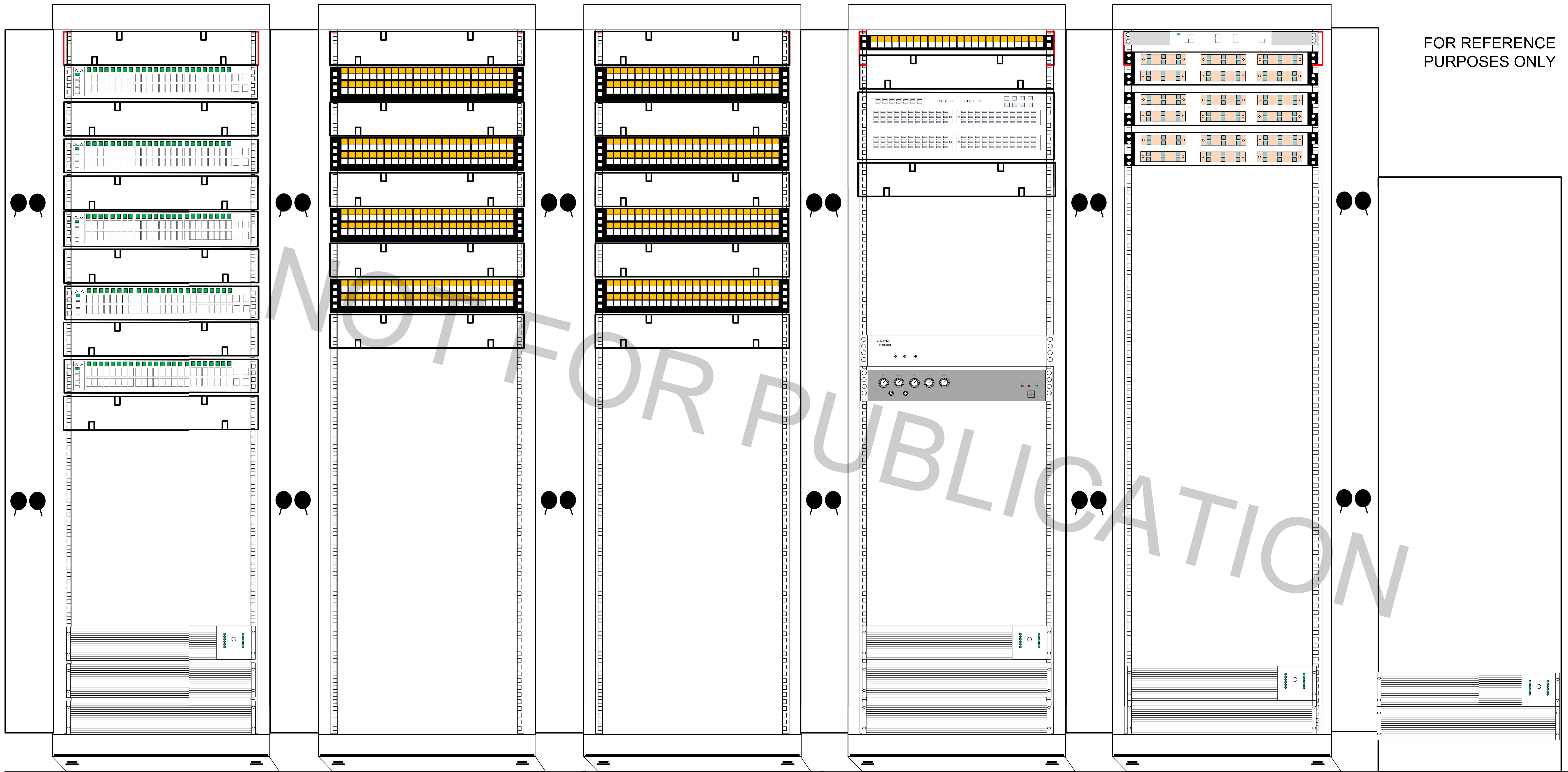

FINISHED FLOOR

Chatsworth Horizontal Cable Manager
P/N 30330-719 - Contractor provided / Quantities Site Specific

Network Components - Owner Provided / Installed

APC 5K UPS / APC 192V Battery pack - Owner Provided / Installed

NEMA L6 - 30R receptacle located behind rack at 80" A.F.F.U.O.N. - Contractor Provided / Installed

NEMA 5 - 20R quad receptacle located behind rack at 80" A.F.F.U.O.N. - Contractor Provided / Installed

Rack units 1 - 14 to remain empty (free of patch panels / LIU (Bottom up))

Standard Rack - 7 feet tall (45U) / 19 inches wide - Black - Contractor Provided / Installed

Chatsworth Horizontal Cable Manager
P/N 30330-719 - Contractor provided / Quantities Site Specific

Patch Panel Components / Hardware - Contractor Provided / Installed

Rack units 1 - 10 to remain empty (free of patch panels / LIU (Bottom up))

Standard Rack - 7 feet tall (45U) / 19 inches wide - Black - Contractor Provided / Installed

Chatsworth Horizontal Cable Manager
P/N 30330-719 - Contractor provided / Quantities Site Specific

Patch Panel Components / Hardware - Contractor Provided / Installed

NEMA 5 - 20R quad receptacle located behind rack at 80" A.F.F.U.O.N. - Contractor Provided / Installed

Rack units 1 - 10 to remain empty (free of patch panels / LIU (Bottom up))

Standard Rack - 7 feet tall (45U) / 19 inches wide - Black - Contractor Provided / Installed

Chatsworth Horizontal Cable Manager
P/N 30330-719 - Contractor provided / Quantities Site Specific

Voice Patch Panel - Contractor Provided / Installed

Network Components - Owner Provided / Installed

APC 5K UPS / APC 192V Battery pack - Owner Provided / Installed

TCU Headend Equipment - Provided / Installed Rauland Borg 14 U above UPS U.O.N.

NEMA L6 - 30R receptacle located behind rack at 80" A.F.F.U.O.N. - Contractor Provided / Installed

Rack units 1 - 10 to remain empty (free of patch panels / LIU (Bottom up))

Standard Rack - 7 feet tall (45U) / 19 inches wide - Black - Contractor Provided / Installed

Chatsworth Horizontal Cable Manager
P/N 30330-719 - Contractor provided / Quantities Site Specific

Spectrum Components - Vendor Provided / Installed

Fiber Optic Campus Box (LIU) - Contractor Provided / Installed

APC 2200 UPS / APC 72V Battery pack - Owner Provided / Installed

NEMA 5 - 20R quad receptacle located behind rack at 80" A.F.F.U.O.N. - Contractor Provided / Installed

Rack units 1 - 10 to remain empty (free of patch panels / LIU (Bottom up))

Standard Rack - 7 feet tall (45U) / 19 inches wide - Black - Contractor Provided / Installed

APC - NetShelter SX 42U (AR3100) Enclosure - Contractor Provided / Installed

Network Components - Owner Provided / Installed

APC 5K UPS / APC 192V Battery pack - Owner Provided / Installed

NEMA L6 - 30R receptacle located behind rack at 80" A.F.F.U.O.N. - Contractor Provided / Installed

TYPICAL CD (MDF) RACK CONFIGURATION

FOR REFERENCE PURPOSES ONLY

FOR REFERENCE PURPOSES ONLY

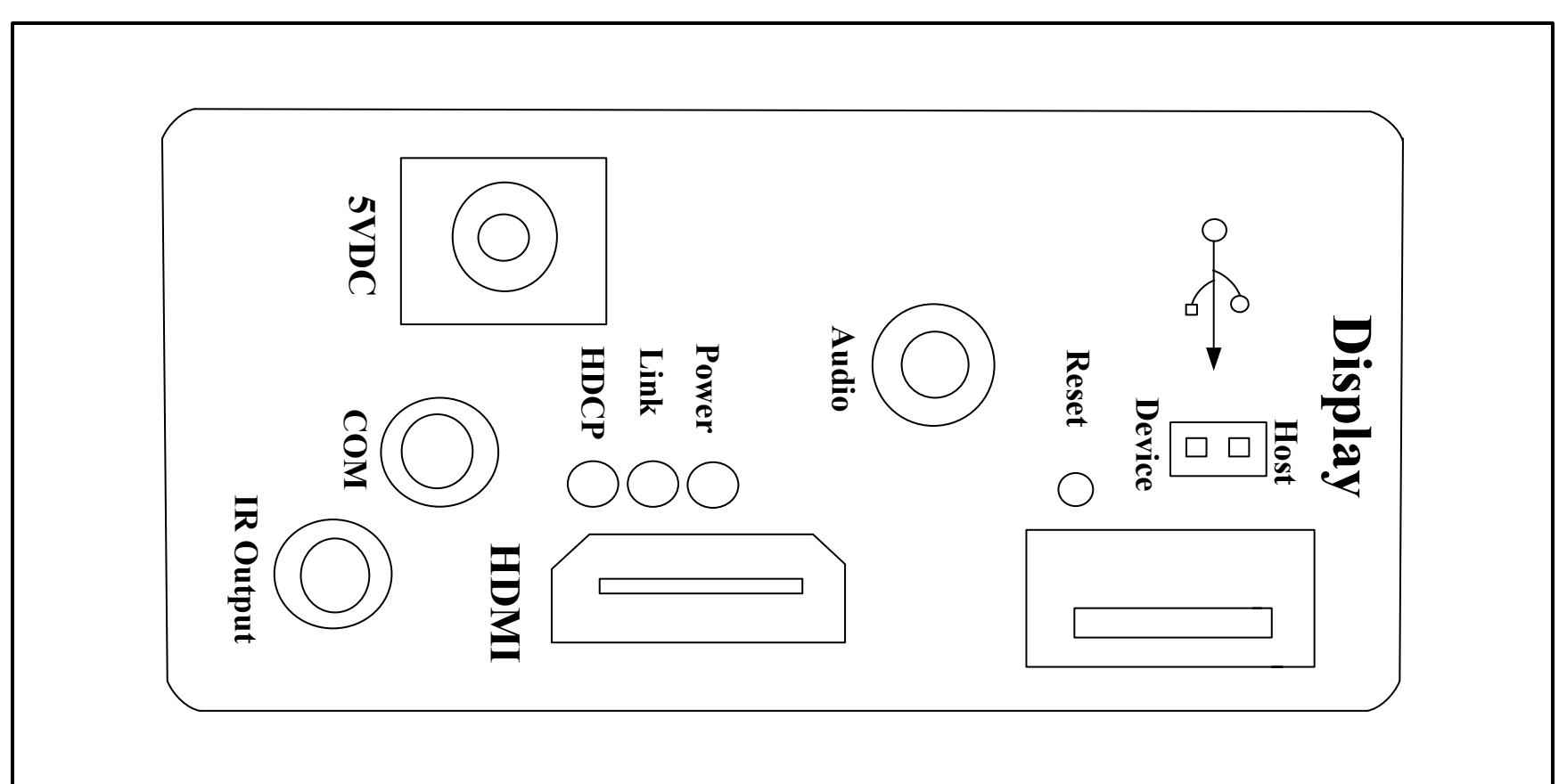
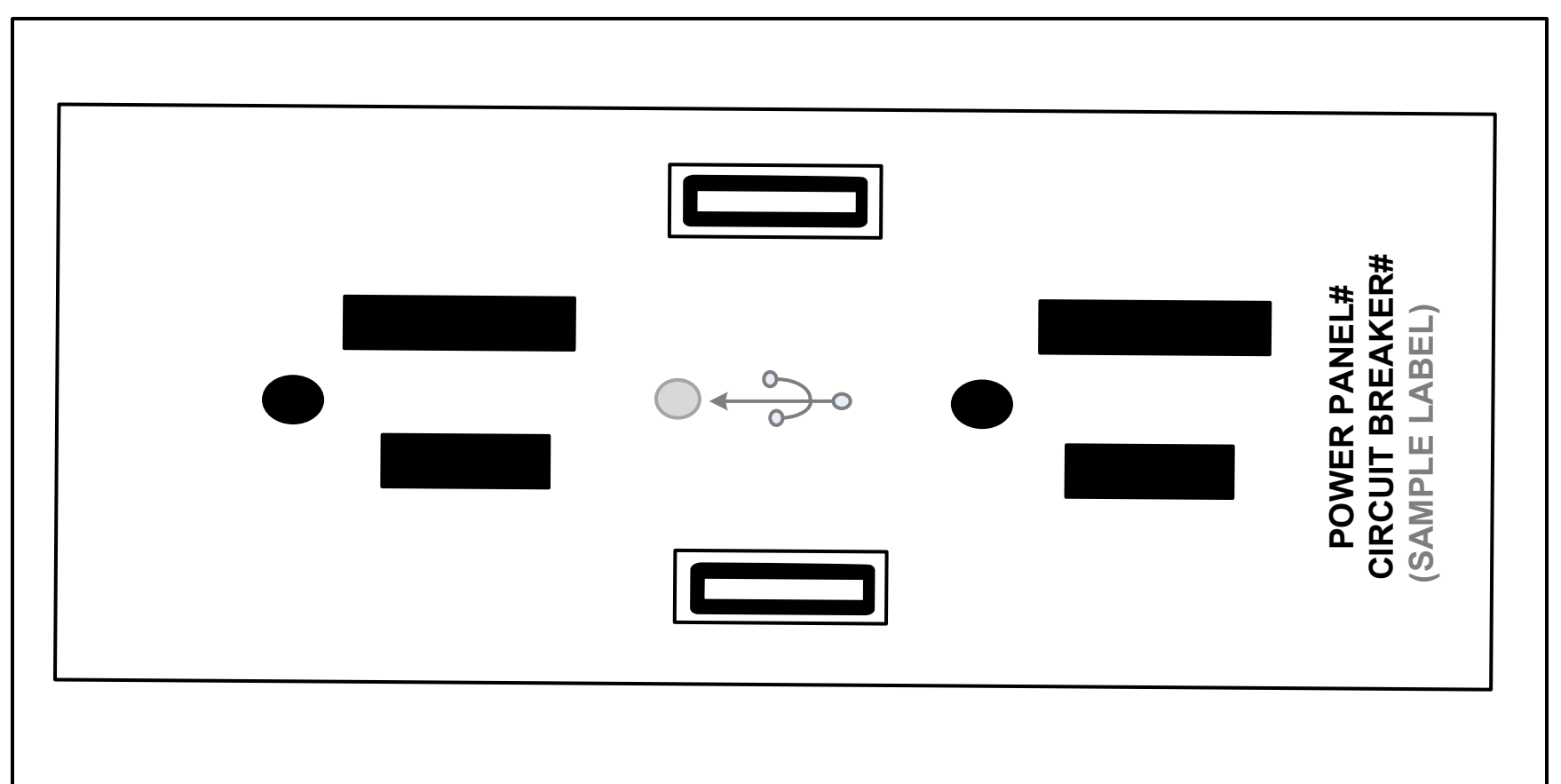
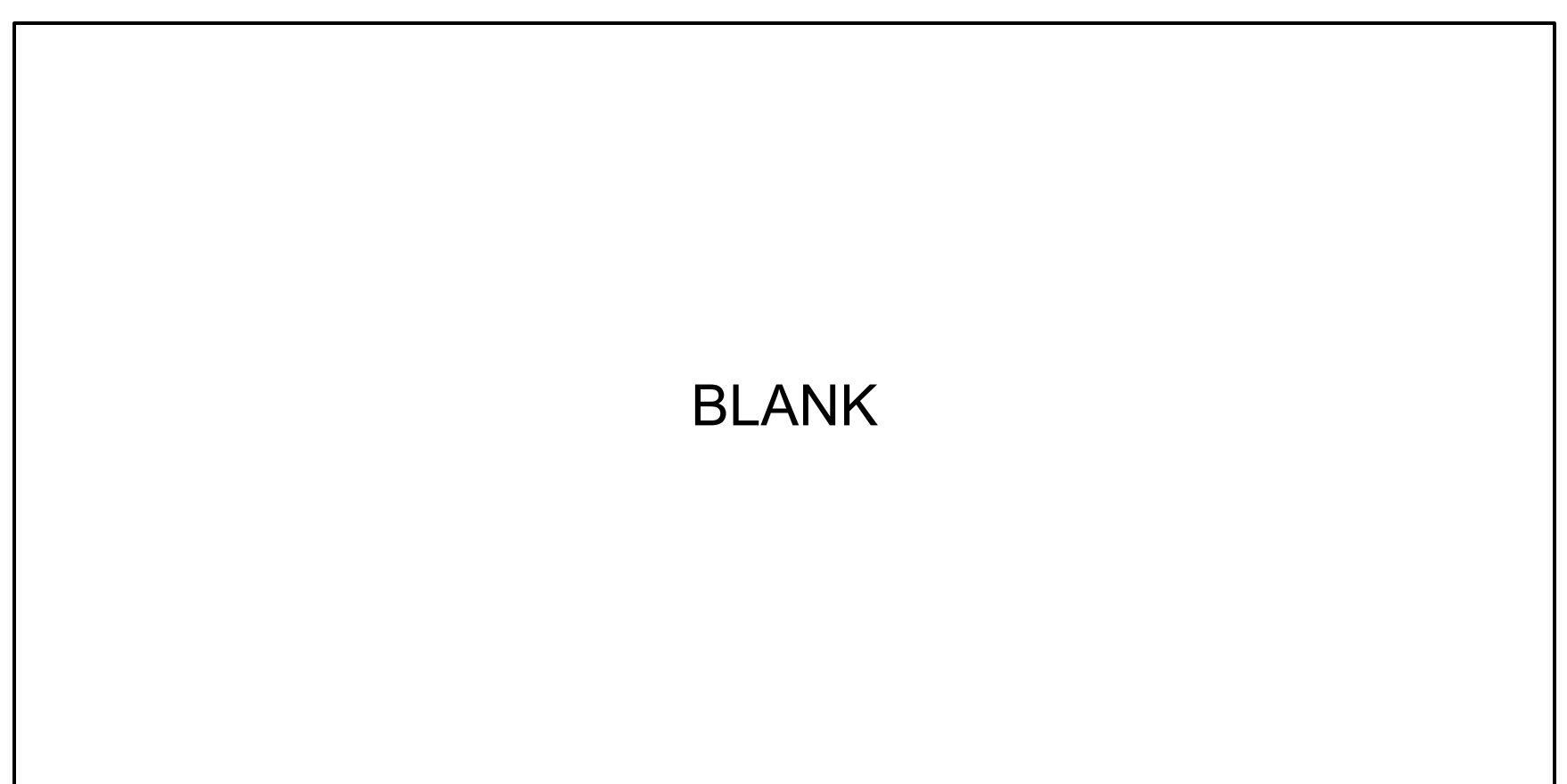
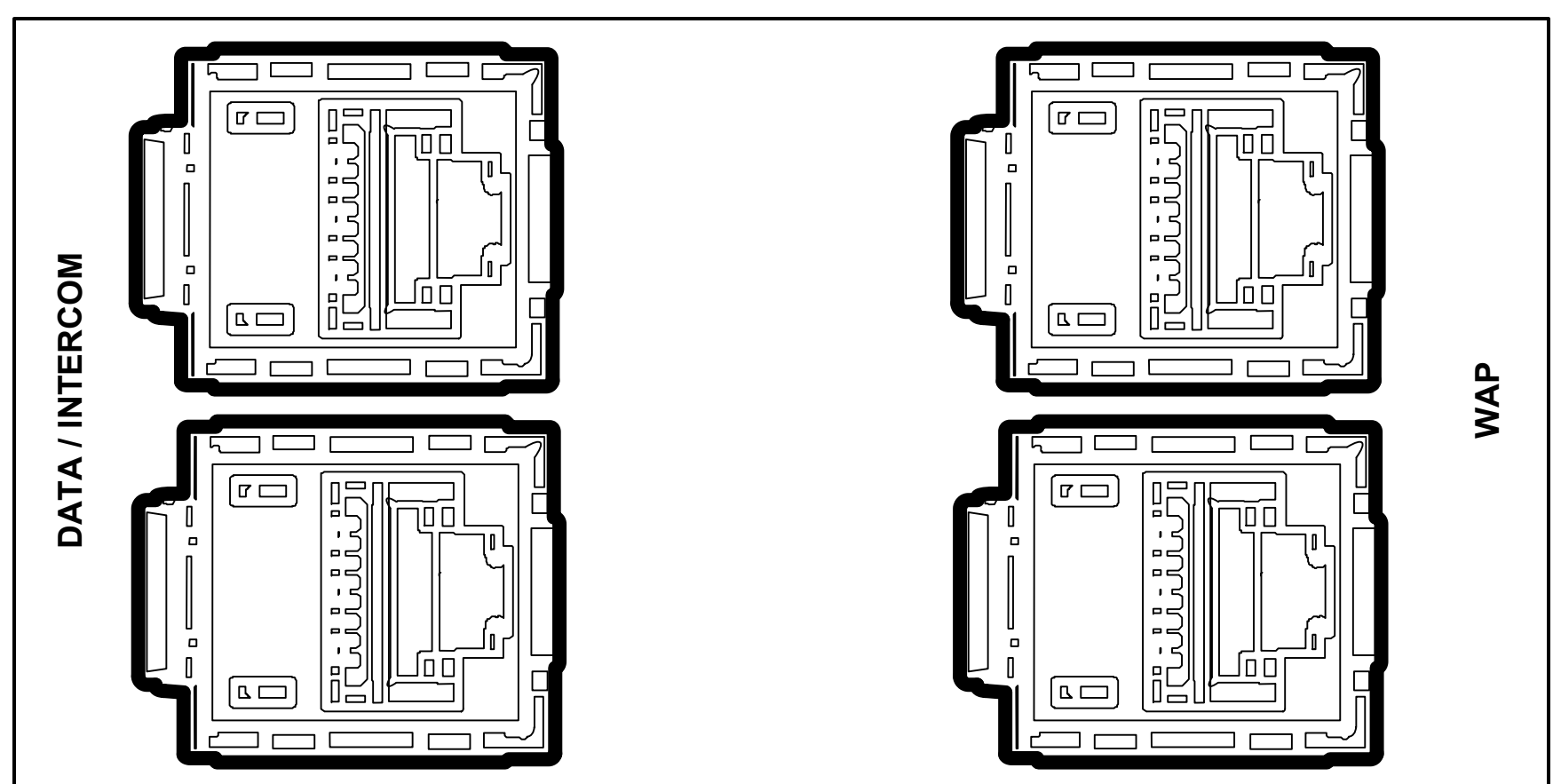
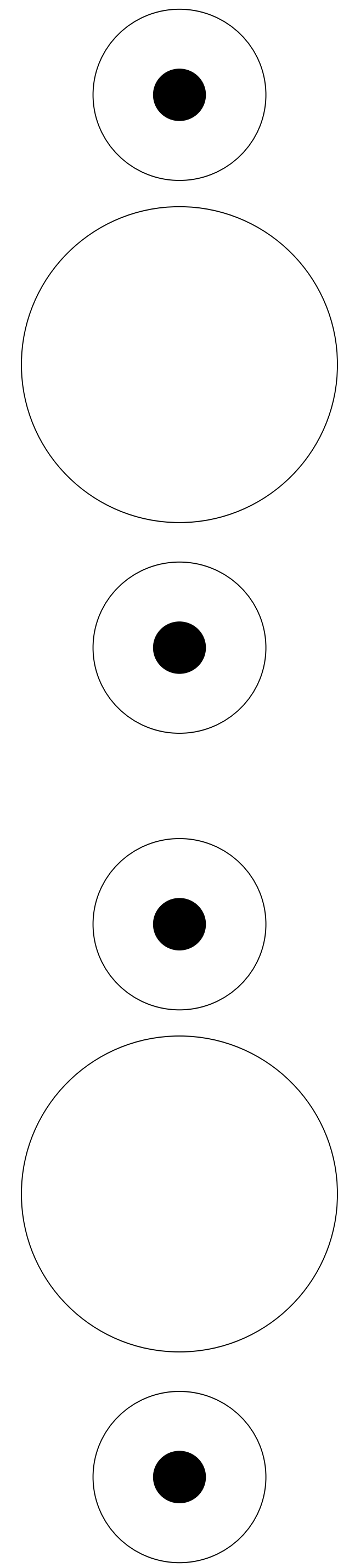
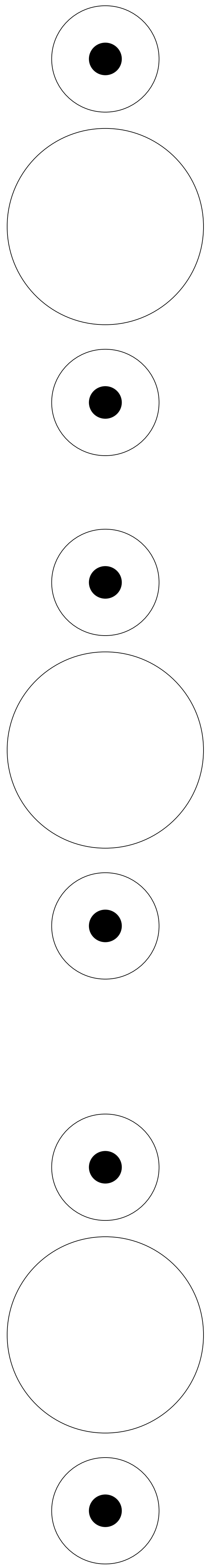
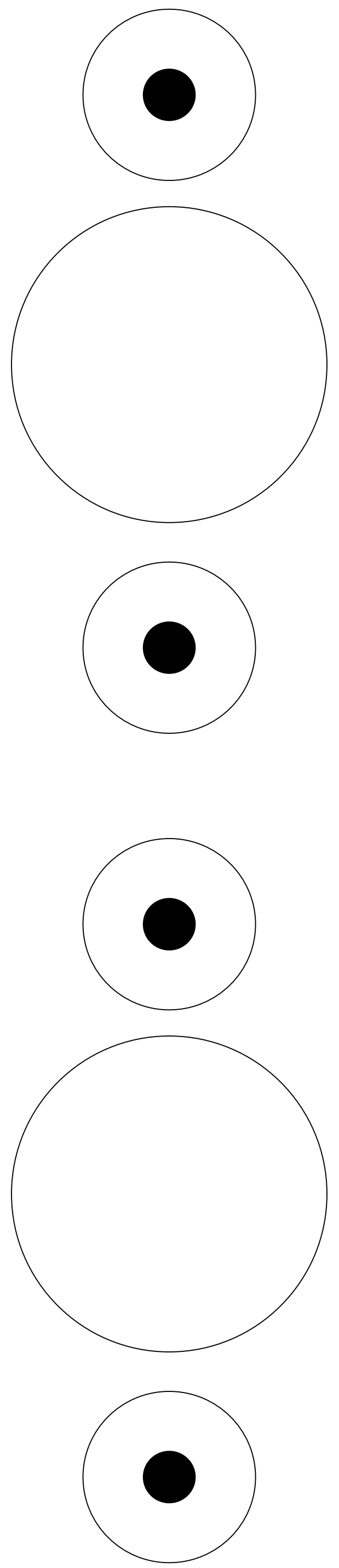

PROJECTOR
PLATE
ASSEMBLY
(TYPICAL)

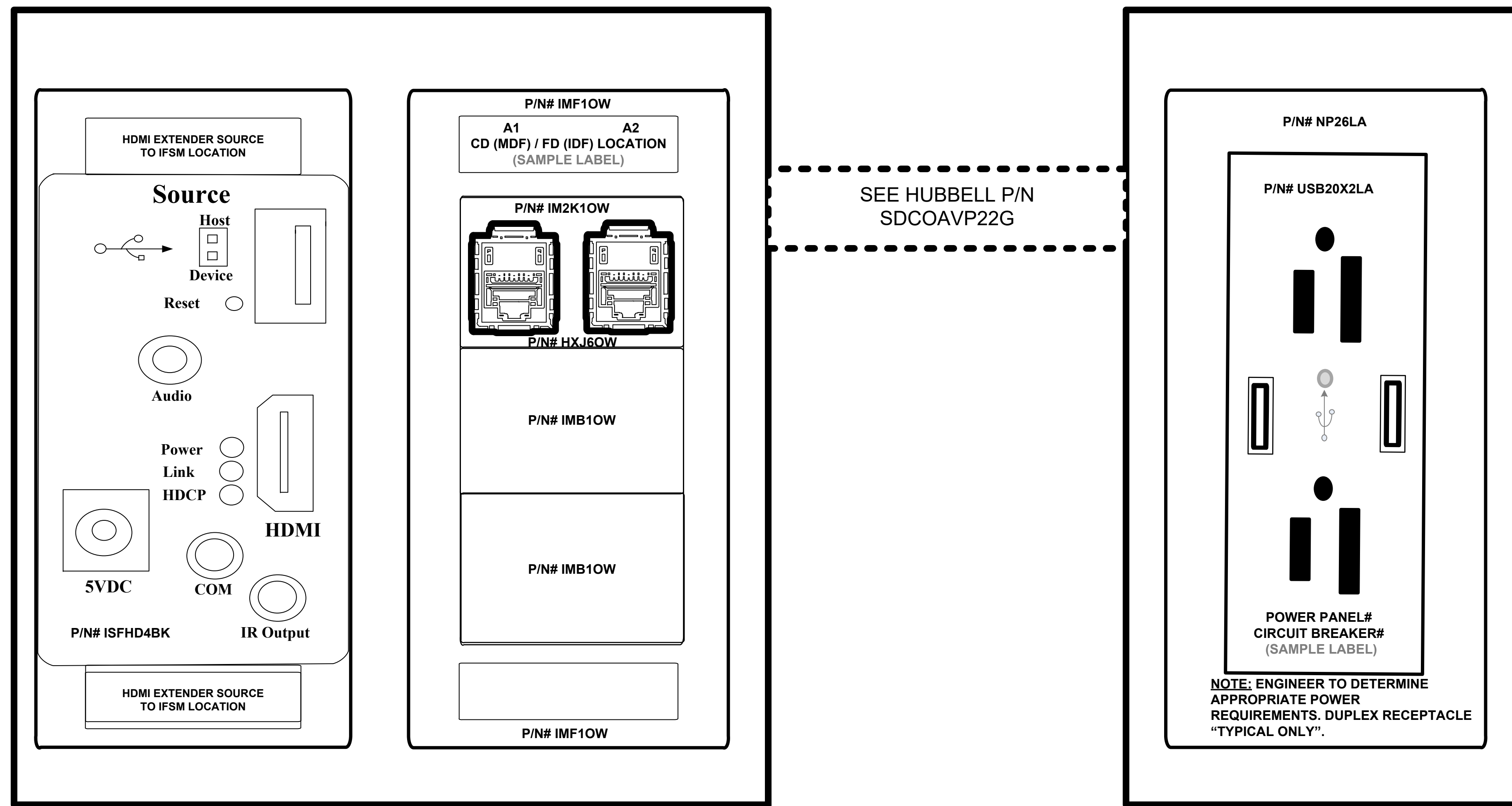

NOTE: PROVIDE AND INSTALL ONE (1) 5V DC POWER OUTPUT PLUG FOR CONNECTIONS AT RECEPTACLE TO POWER HDMI MODULE AT BOTH OUTLETS (IFSM & TS).

SYMBOL - **TS**

STATION "TS" SUPPORT OUTLET TYPICAL BUILD OUT INSTALLATION DETAIL

NOT TO SCALE

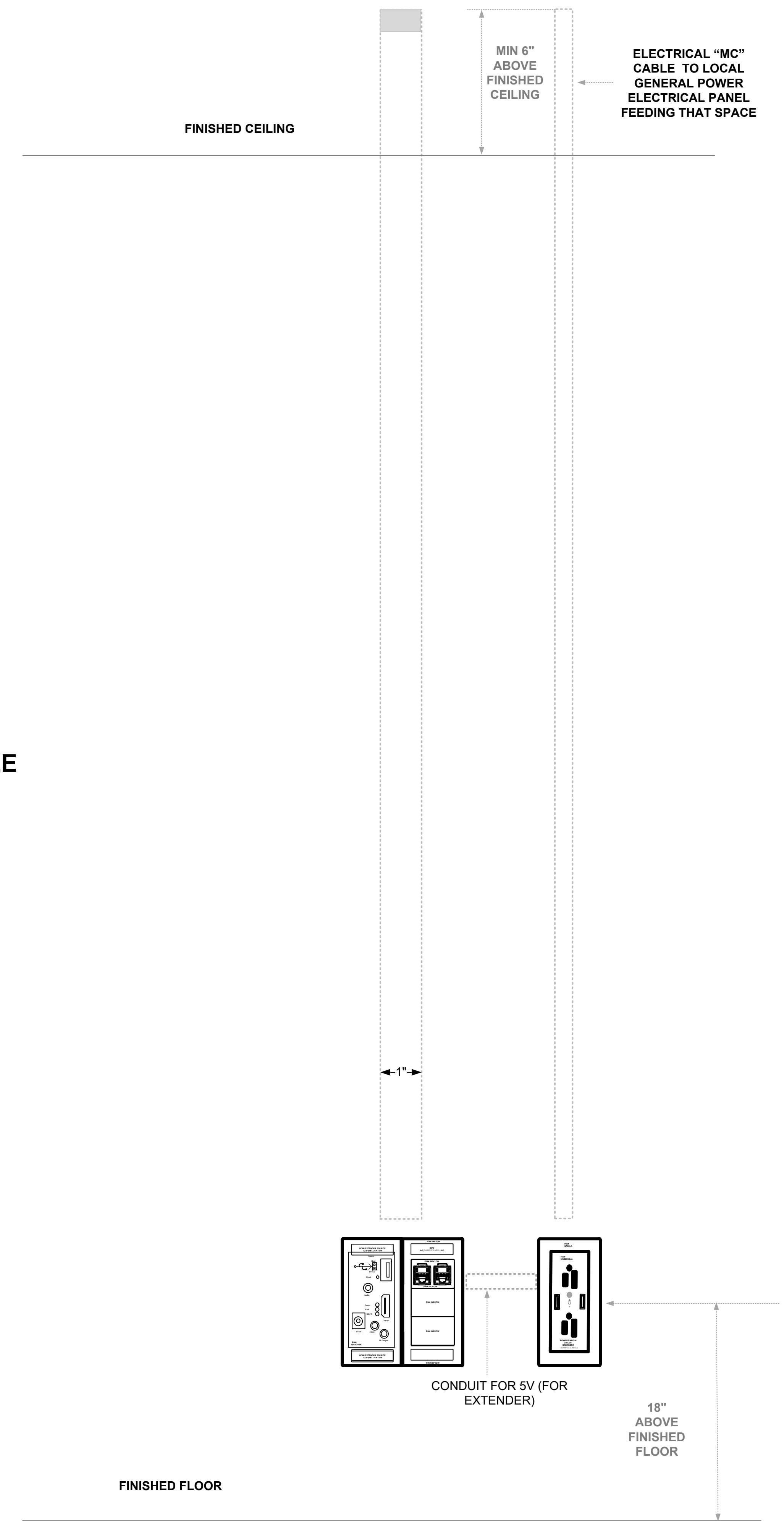

SOURCE STATION SIDE

A/V MODULE ISFHD4BK KIT INCLUDES:
 (1) ISFHDR4BK Rx DISPLAY SIDE MODULE
 (1) ISFHDT4BK Tx SOURCE SIDE MODULE

ISFHDT4BK SOURCE Tx MODULE
 REQUIRES ISFHDR4BK Rx MODULE
 ON DISPLAY SIDE

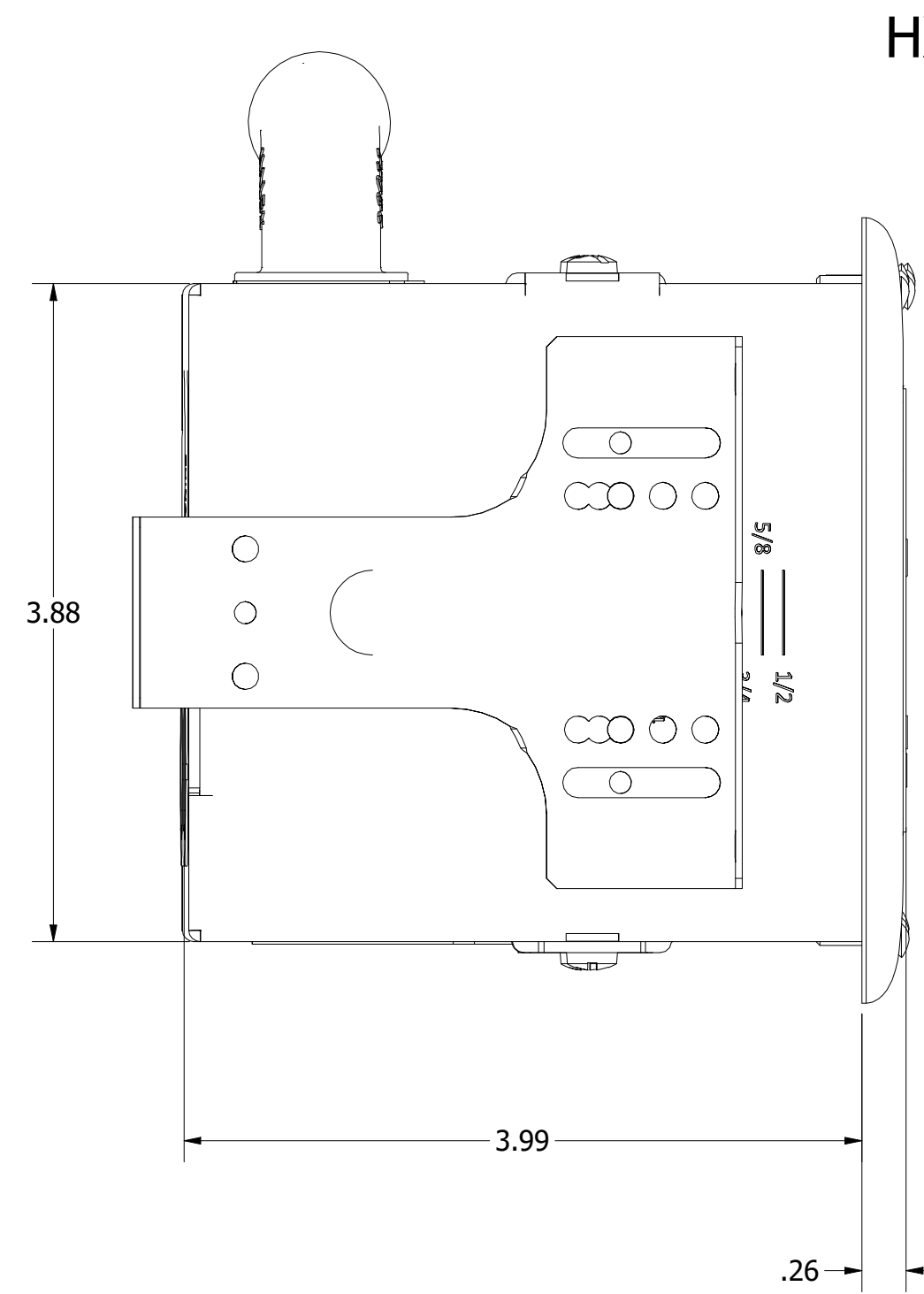

HXJ6xx (2)

NS612xx

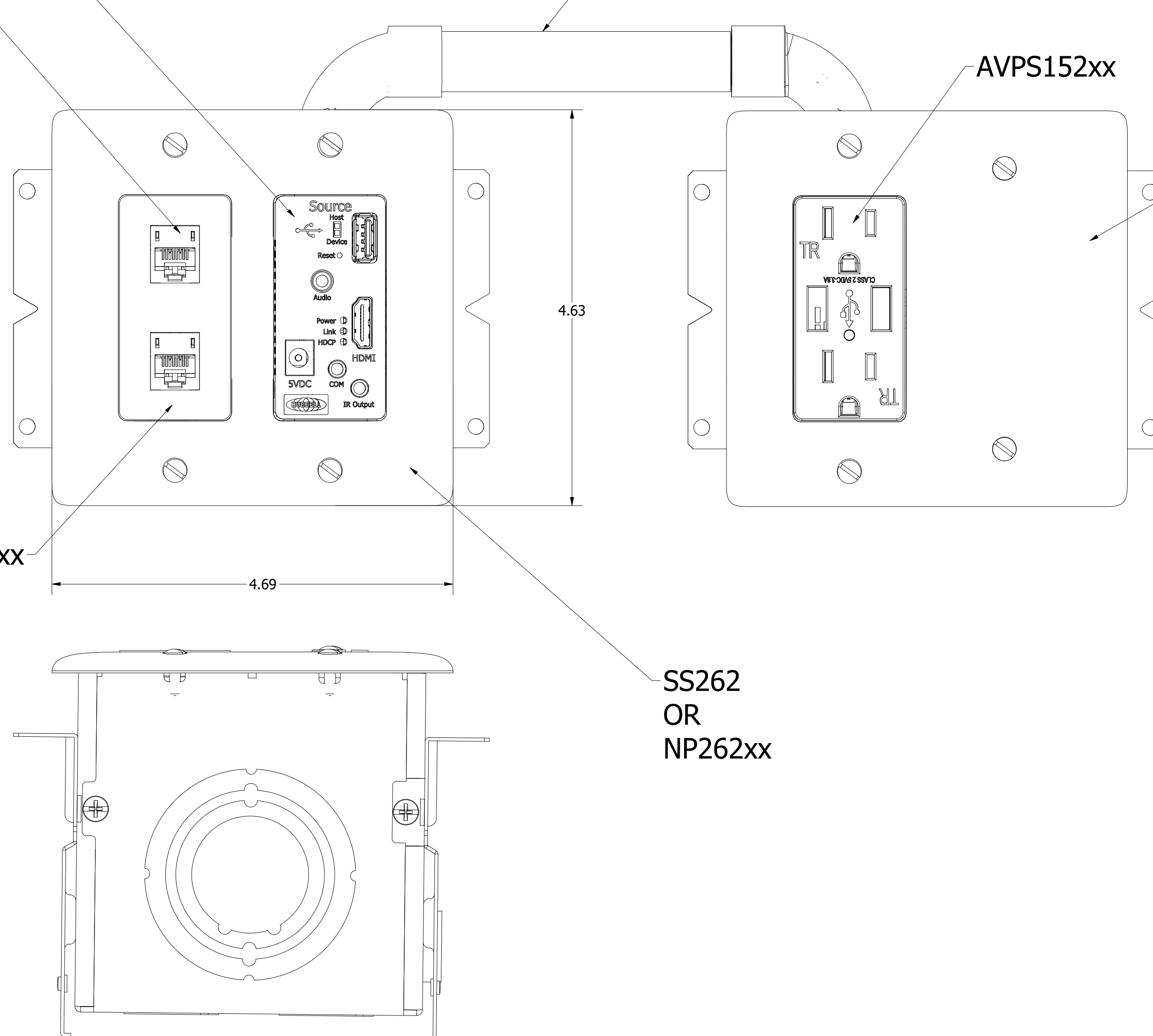

5V DC FROM AVPS152BK
 TO ISFHDT4BK SOURCE Tx MODULE

AVPS152xx

NP1326xx
 OR STAINLESS STEEL

SS262
 OR
 NP262xx

HBL985

HBL985

HBL985

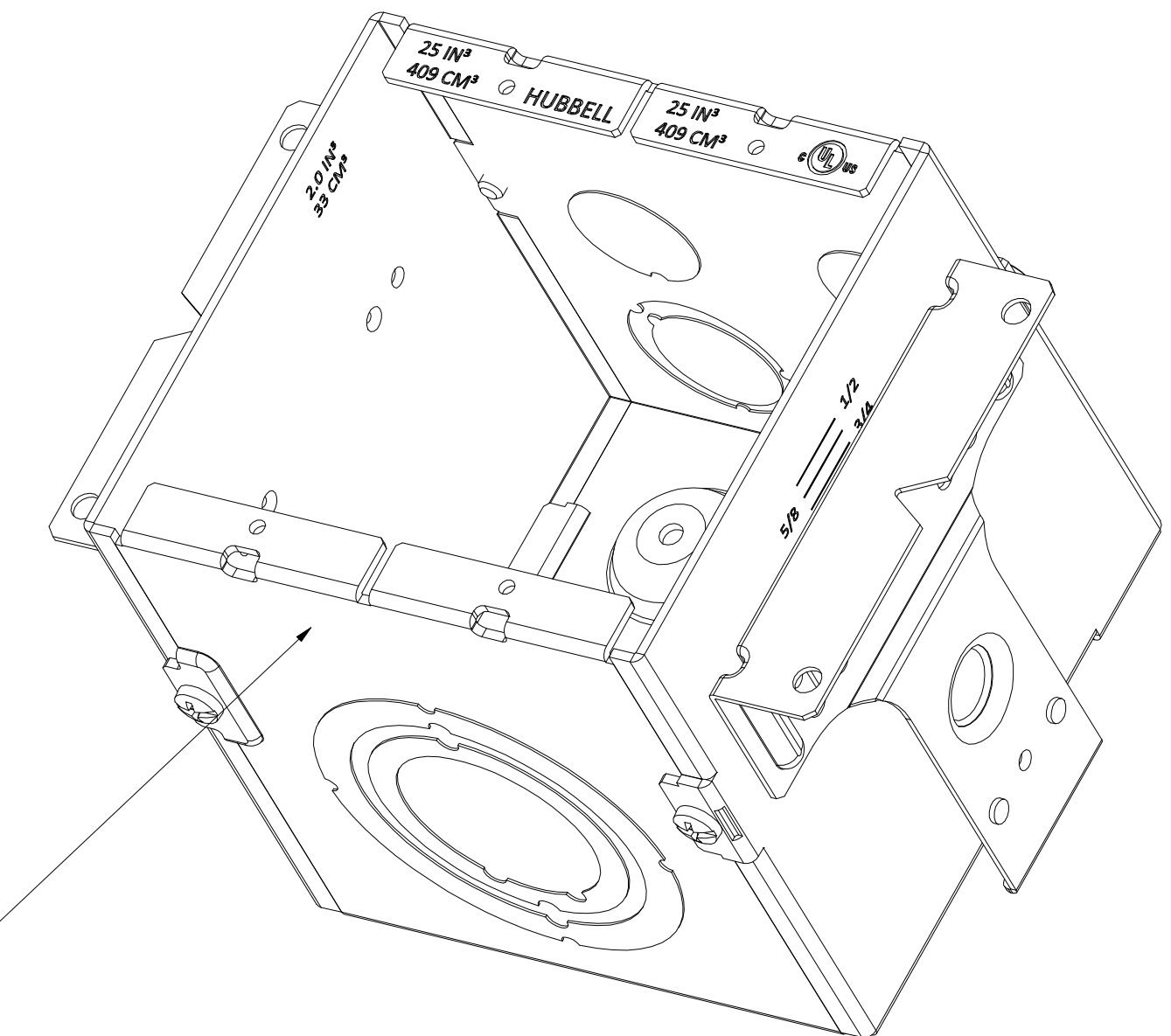
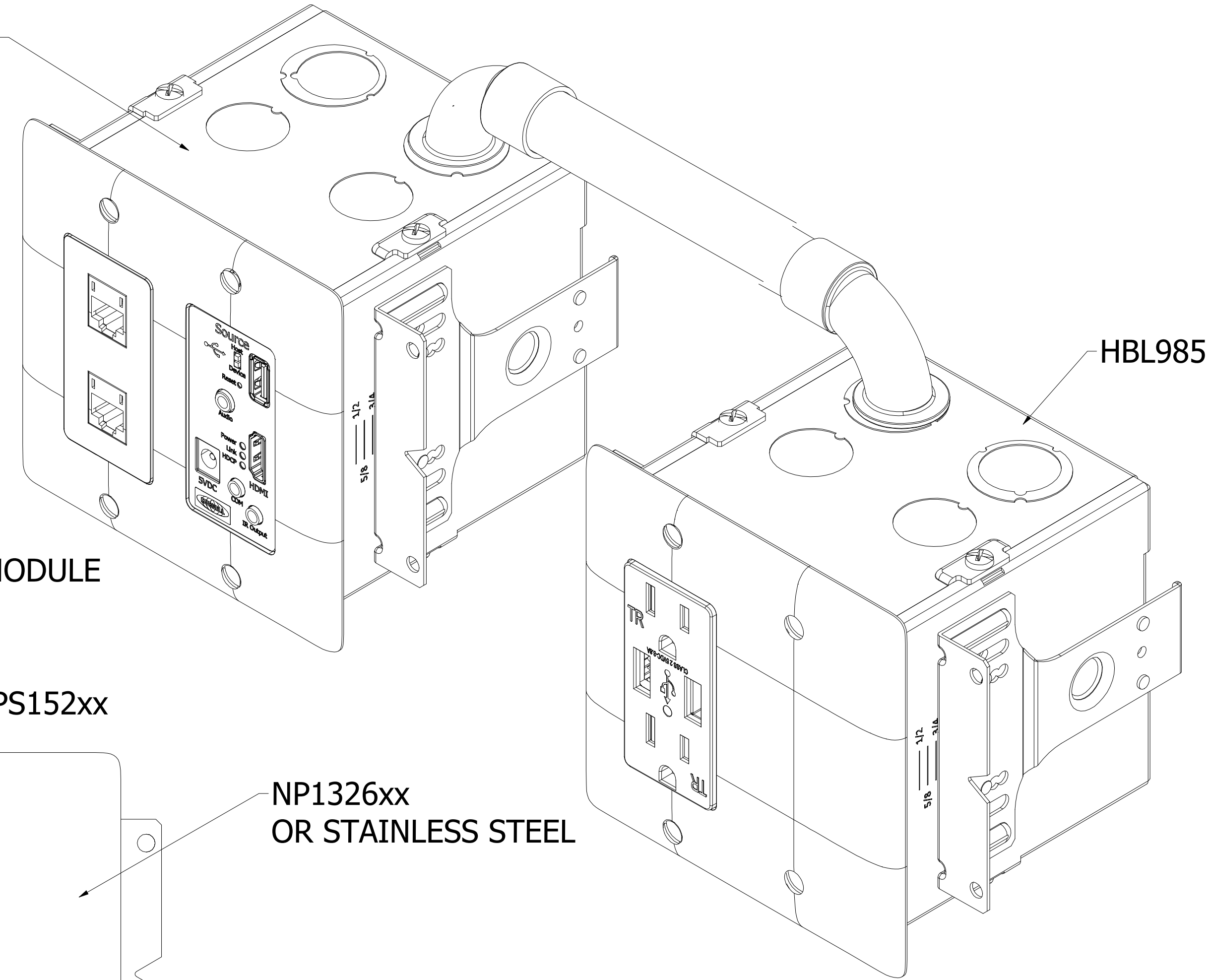

Created on INVENTOR	DIMENSIONING AND TOLERANCE PER ANSI Y14.5M-1982 UNLESS OTHERWISE SPECIFIED, DIMENSIONS ARE IN INCHES (MM). TOLERANCES: XX = ±.01 (.25) .XXX = ±.005 (.127) .XXXX = ±.0025 (.0635) ANGLE TOL ±1°	PROJECT REFERENCE: N/A	Hubbell Premise Wiring HUBBELL INCORPORATED (Delaware) 23 CLARA DRIVE, SUITE 103 MYSTIC, CT 06355		
	MATERIAL: N/A	TITLE: 2 GANG 4KAV, SOURCE LOCATION WITH POWER			
	IN ACCEPTING OUR DRAWINGS, BLUEPRINTS, OR SUPPORTING DOCUMENTATION FOR QUOTATION OR OTHER PURPOSES, YOU AGREE NOT TO DISCLOSE TO OTHERS THE IDEAS, INFORMATION, OR DESIGNS SHOWN HEREIN, AND THAT YOU WILL MAKE NO USE OF SAME WITHOUT PERMISSION	DRAWN BY: D.O'CONNOR 8/5/20	SIZE: D	DRAWING NO.: SDOCAVP22G	REV.: 1
	CHECKED BY:	APPROVED BY:	SCALE:	SHEET 1 OF 1	

(NOT TO SCALE)

SDOC RJ45 MODULAR JACK AND PATCH PANEL PORT
TERMINATION METHOD 568 "A" ONLY CONFIGURATIONS U.O.N.

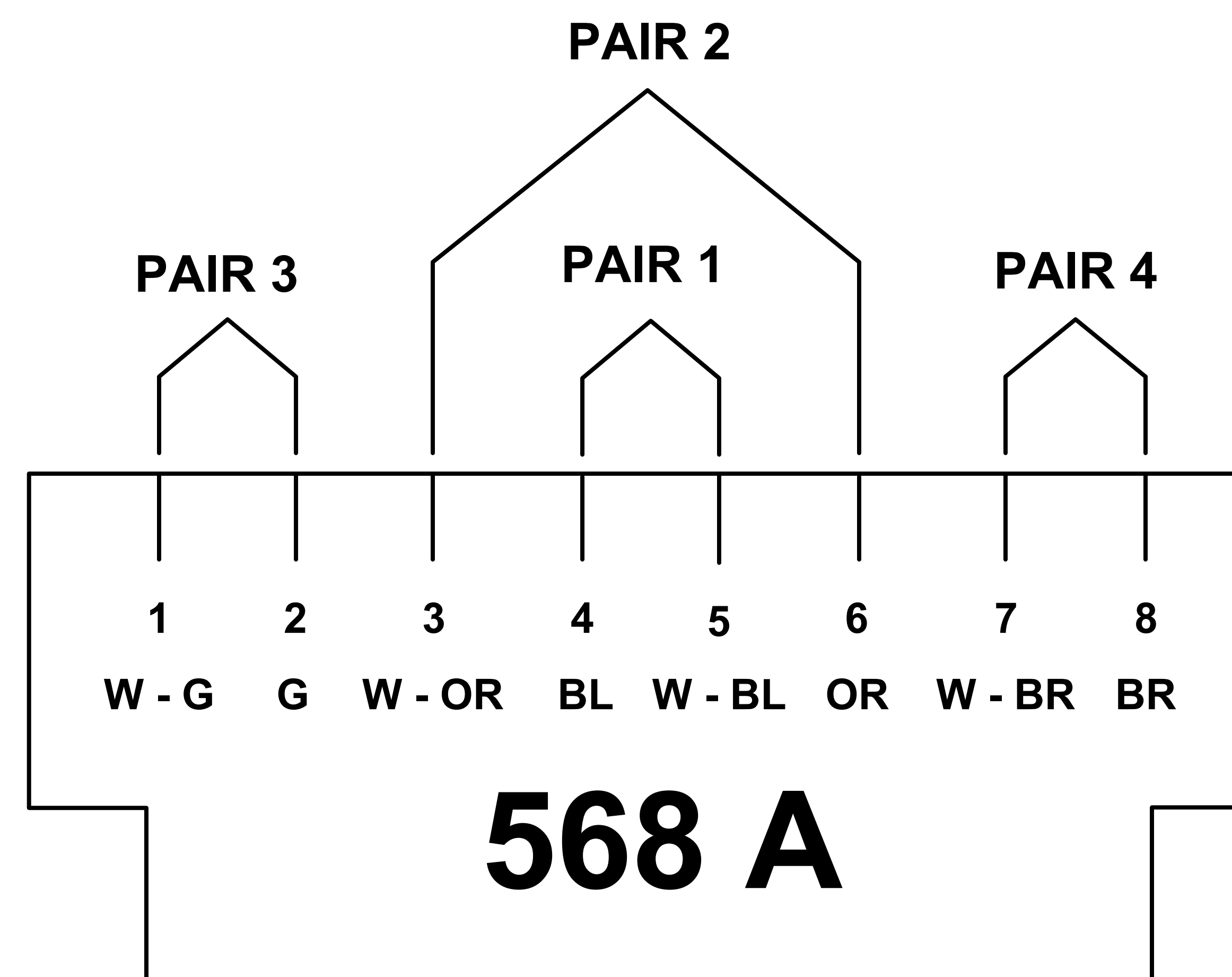

NOTE:

EIGHT (8) - POSITION JACK PIN / PAIR ASSIGNMENTS EIA / TIA - 568A.

(ALL FOUR (4) PAIR CATEGORY 6A COPPER DATA CABLES
SHALL BE TERMINATED IN THIS CONFIGURATION "ONLY"
FOR ALL SCHOOL DISTRICT OF OSCEOLA COUNTY, FLORIDA CONFIGURATIONS.

**SDOC CATEGORY 6A MODULAR JACK WIRING
CONFIGURATION DETAIL "TYPICAL"**

(NOT TO SCALE)

UTILITY VAULT NOTES:

1. INSTALL IN ACCORDANCE WITH THE MANUFACTURER’S PRINTED INSTRUCTIONS AND THESE REQUIREMENTS.
2. ANSI / SCTE 77 TIER RATED FOR ENVIRONMENT AS DETERMINED APPLICABLE BY PROJECT ENGINEER.
3. DESIGN CONCRETE STRUCTURE AND STEEL COVER FOR HS-20-44 LOADING LIDS ARE TO HAVE HANDLES AND BE SPRING LOADED. ALL VAULTS ARE TO HAVE OPEN BOTTOMS.
4. USE ASTM A-615 REINFORCING STEEL WITH 60,000 psi YIELD.
5. ONE (1) LID MUST HAVE “COMMUNICATIONS” LOGO PERMANENTLY STAMPED.
6. 24" GRAVEL BASE EXTEND 12" BEYOND EXTERIOR OF VAULT ON ALL SIDES.
7. PROVIDE INSERTS FOR TWO CABLE RACKS ON EACH WALL. LOCATE INSERTS TO CLEAR DUCT ENTRIES.
8. ALL CABLES SHALL BE PROPERLY ROUTED AND SECURED AGAINST THE SIDES OF ALL COMMUNICATION VAULTS USING PROPER SUPPORTS AS REQUIRED.
9. CONTRACTOR SHALL BE RESPONSIBLE FOR ALL PRODUCT AND CODE SPECIFIC REQUIREMENTS FOR INSTALLATION, REGARDLESS OF ERROR OR OMISSION IN THIS INFORMATIONAL DETAIL.
10. MAXIMUM DISTANCE BETWEEN VAULTS SHALL NOT EXCEED 500 FEET - NO EXCEPTIONS

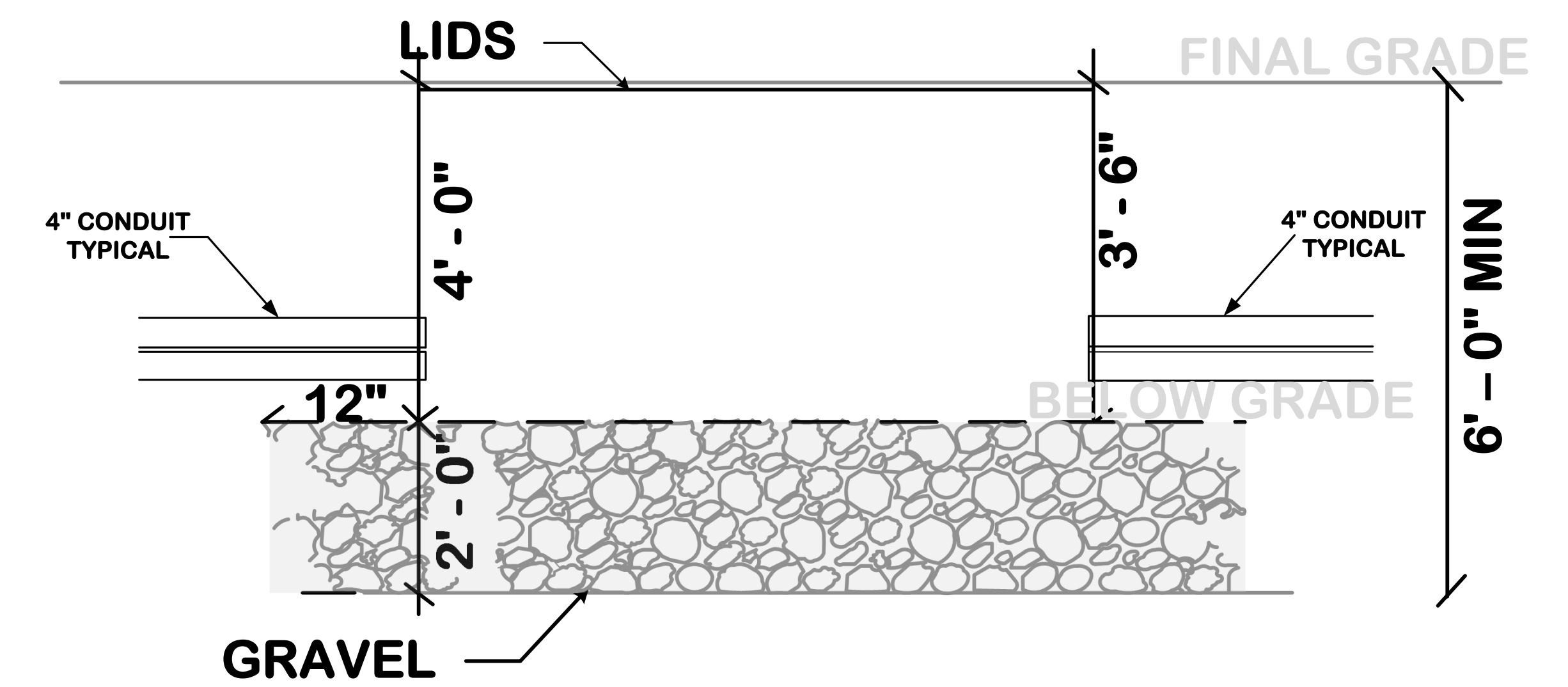
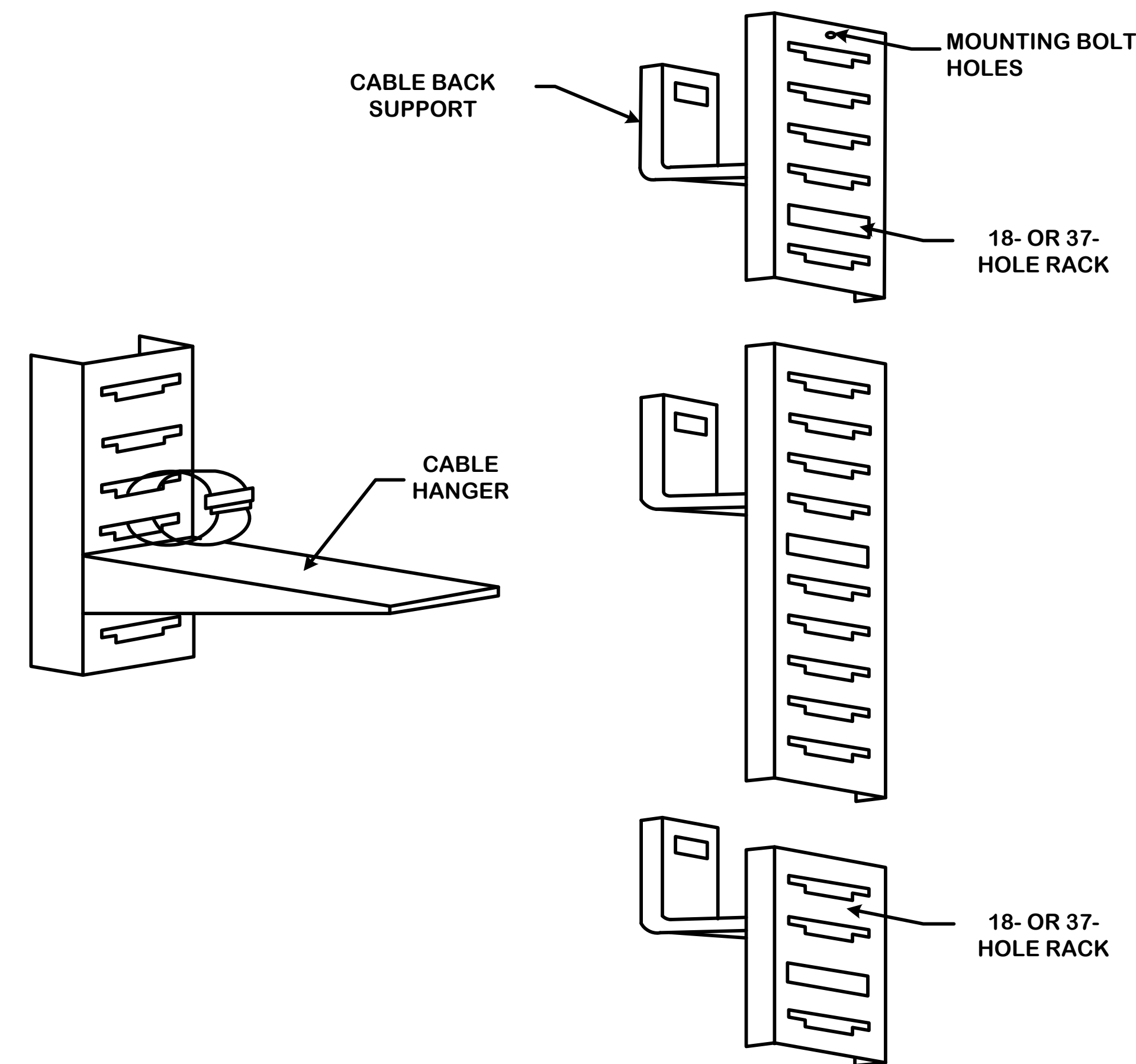
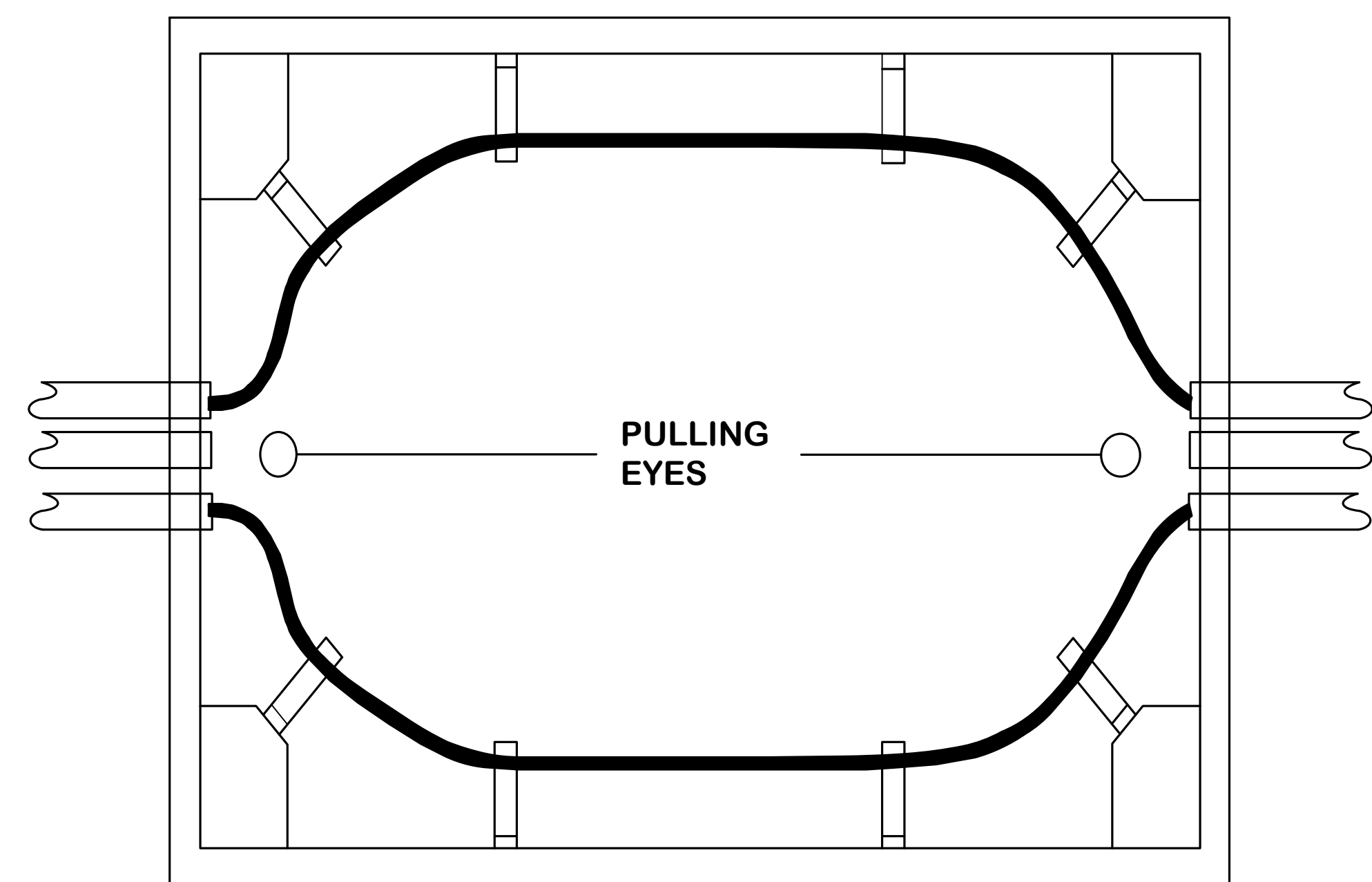
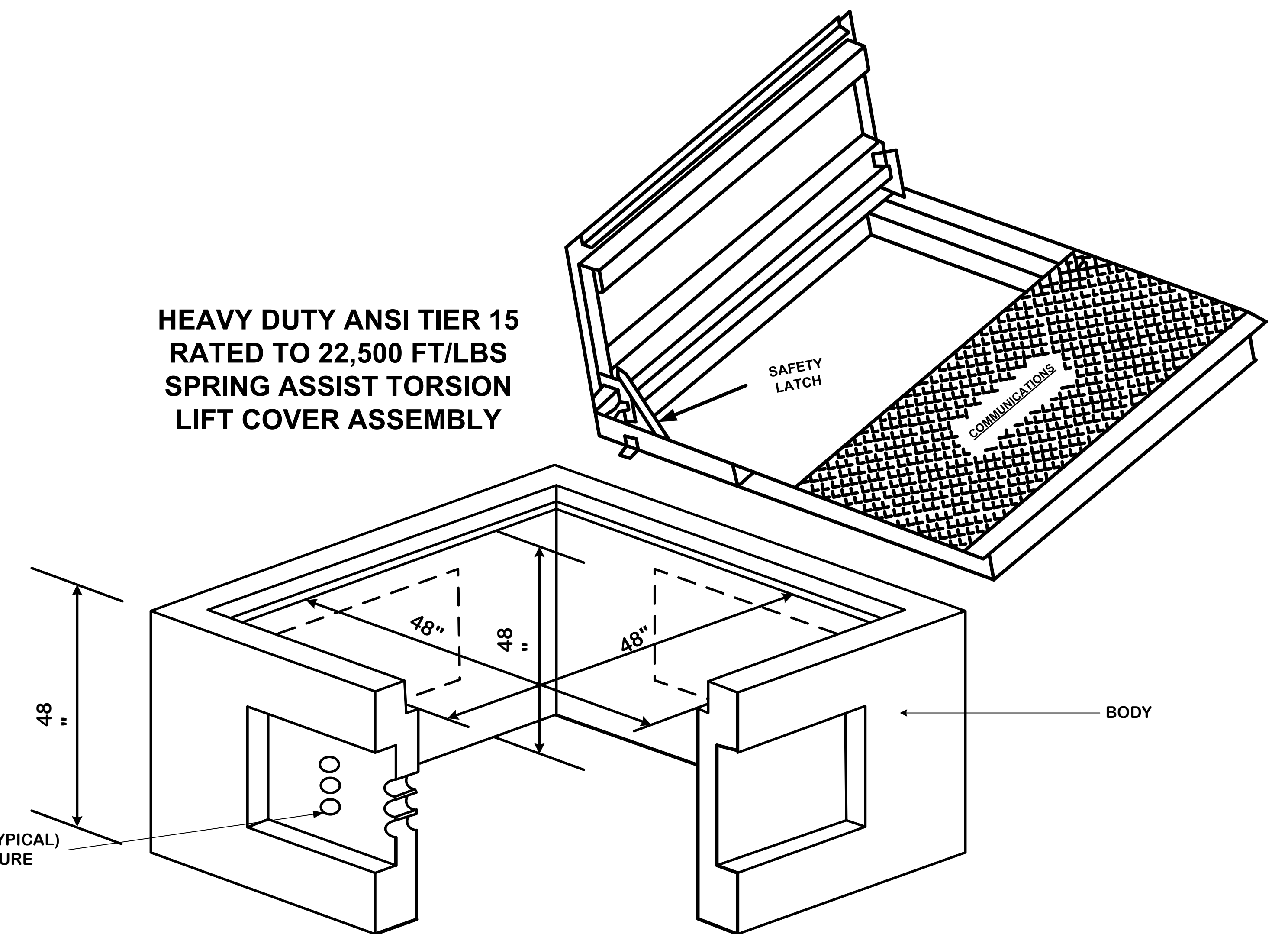

COMMUNICATION VAULTS

(NOT TO SCALE)

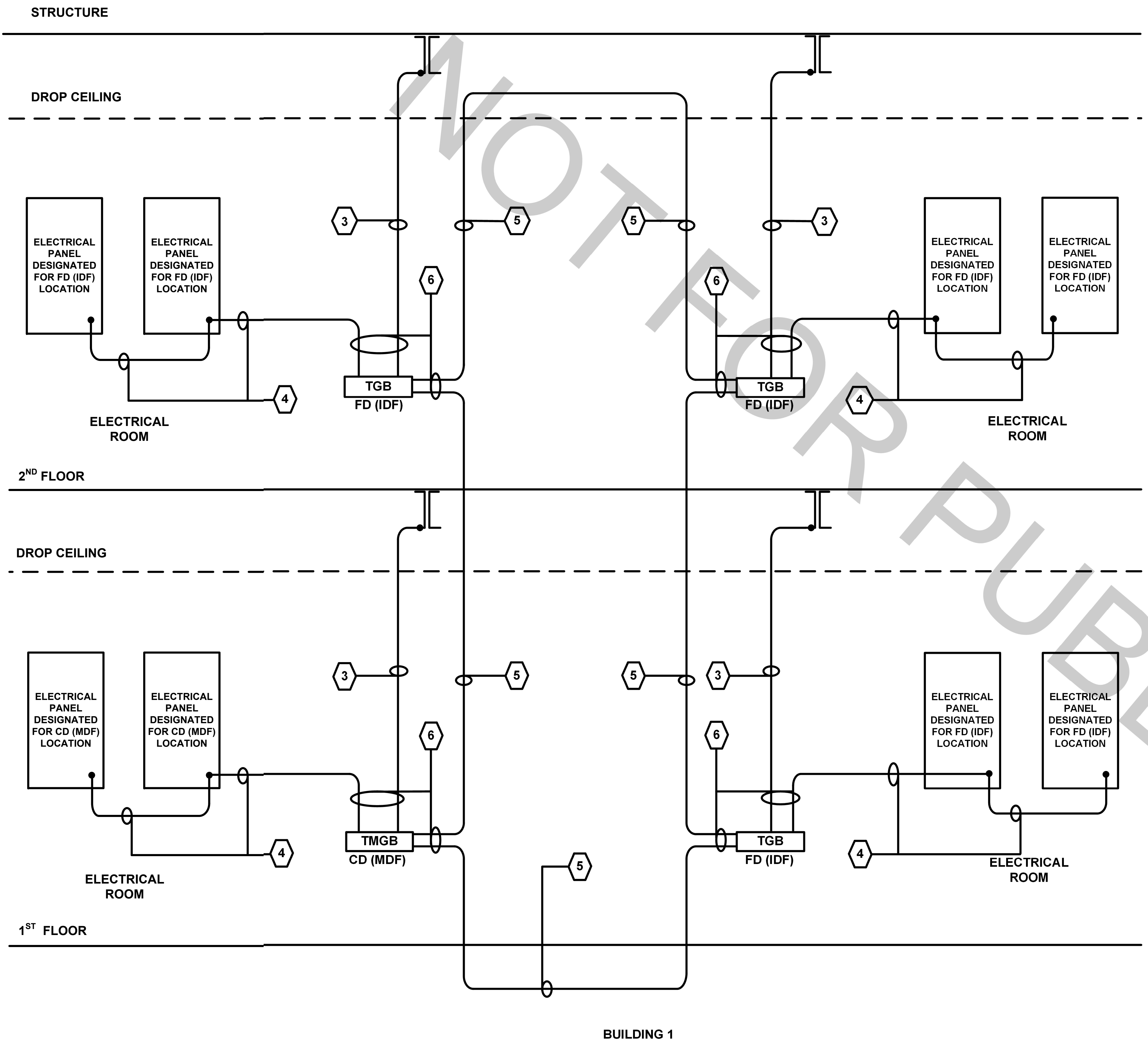

BUILDING 1

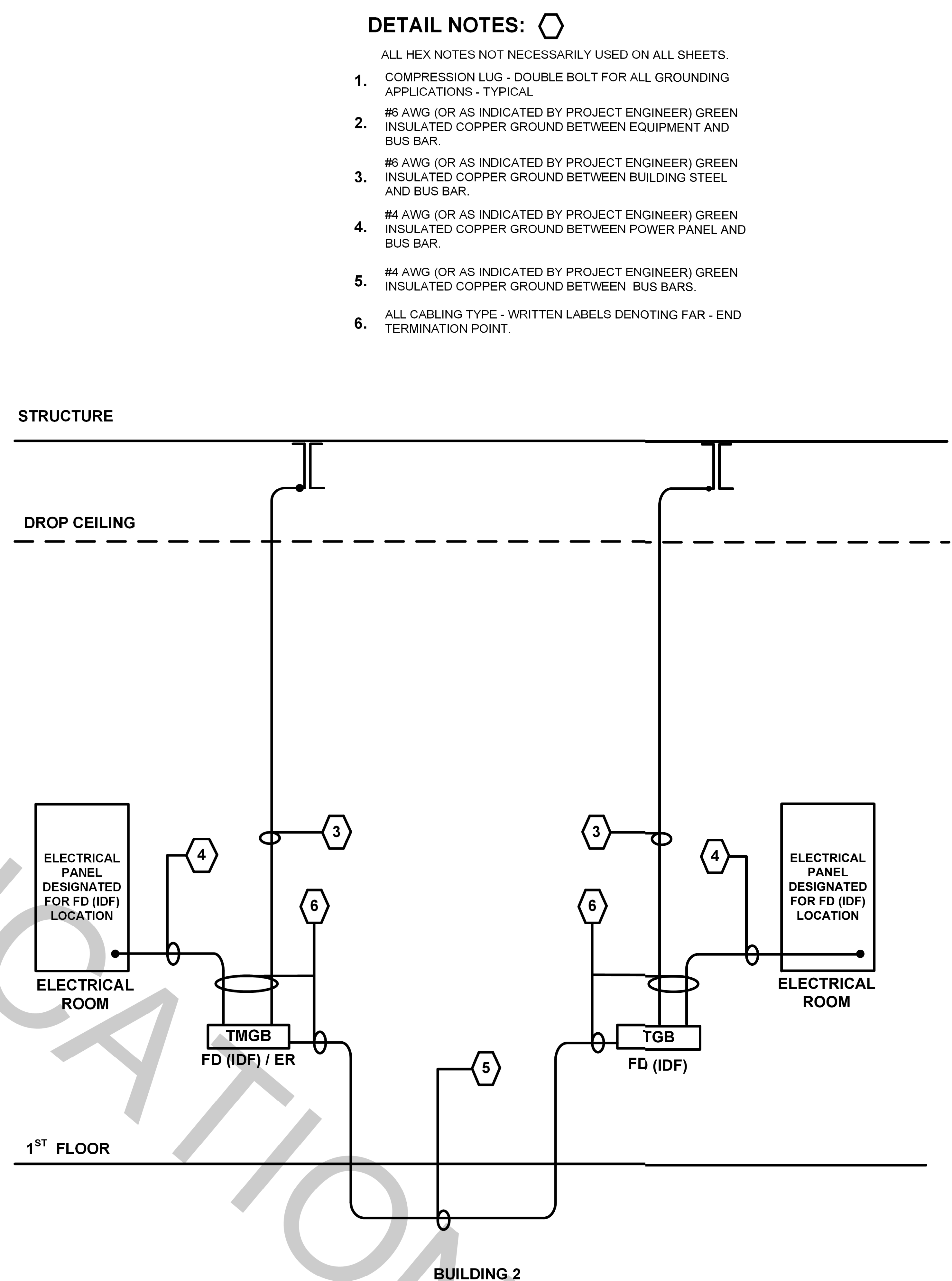

BUILDING 2

DETAIL NOTES: ⬡

- ALL HEX NOTES NOT NECESSARILY USED ON ALL SHEETS.
1. COMPRESSION LUG - DOUBLE BOLT FOR ALL GROUNDING APPLICATIONS - TYPICAL
 2. #6 AWG (OR AS INDICATED BY PROJECT ENGINEER) GREEN INSULATED COPPER GROUND BETWEEN EQUIPMENT AND BUS BAR.
 3. #6 AWG (OR AS INDICATED BY PROJECT ENGINEER) GREEN INSULATED COPPER GROUND BETWEEN BUILDING STEEL AND BUS BAR.
 4. #4 AWG (OR AS INDICATED BY PROJECT ENGINEER) GREEN INSULATED COPPER GROUND BETWEEN POWER PANEL AND BUS BAR.
 5. #4 AWG (OR AS INDICATED BY PROJECT ENGINEER) GREEN INSULATED COPPER GROUND BETWEEN BUS BARS.
 6. ALL CABLING TYPE - WRITTEN LABELS DENOTING FAR - END TERMINATION POINT.

BONDING BACKBONE RISER DIAGRAM

FOR REFERENCE
PURPOSES ONLY

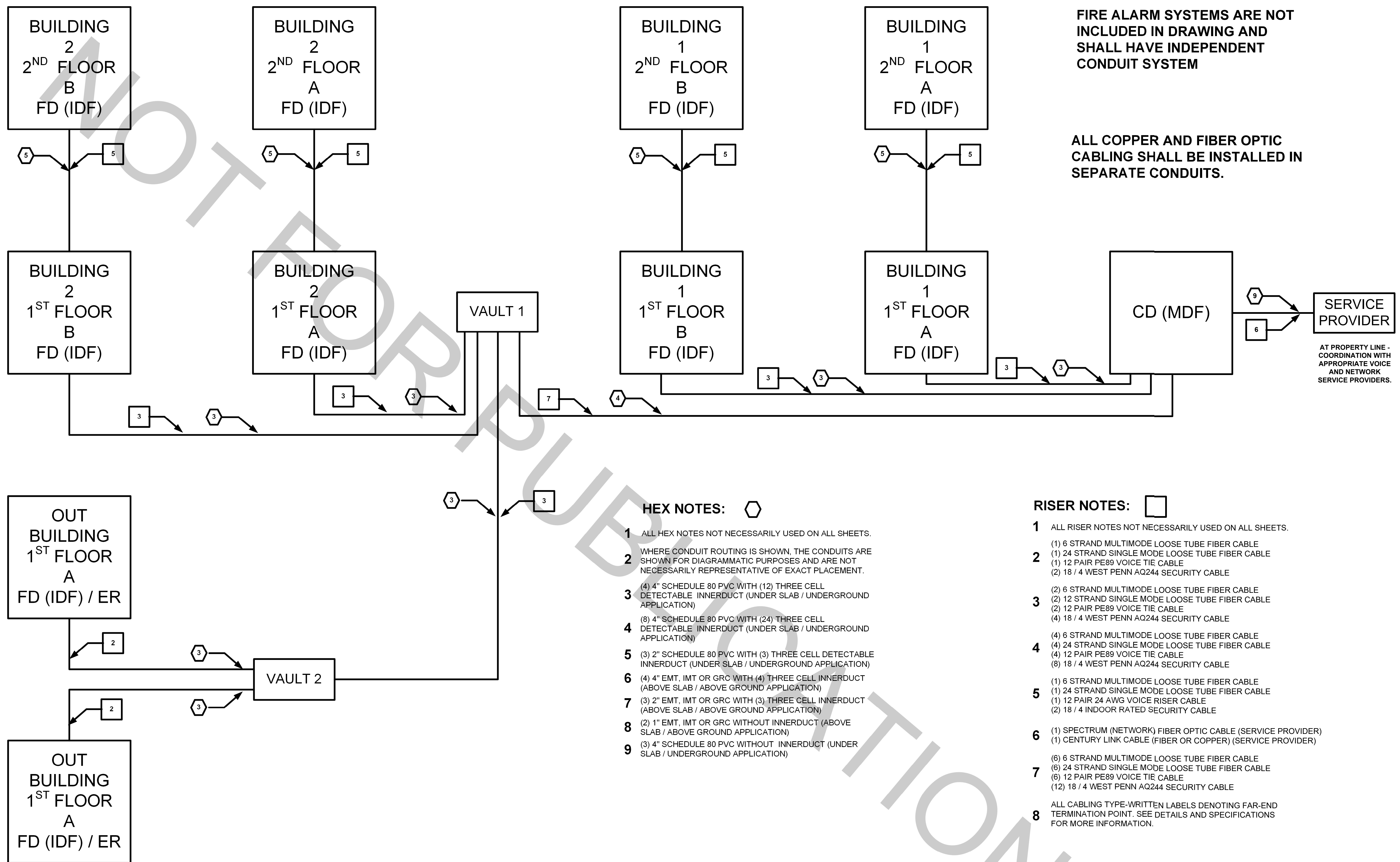

FIRE ALARM SYSTEMS ARE NOT INCLUDED IN DRAWING AND SHALL HAVE INDEPENDENT CONDUIT SYSTEM

ALL COPPER AND FIBER OPTIC CABLING SHALL BE INSTALLED IN SEPARATE CONDUITS.

AT PROPERTY LINE - COORDINATION WITH APPROPRIATE VOICE AND NETWORK SERVICE PROVIDERS.

FOR REFERENCE
PURPOSES ONLY

TYPICAL BACKBONE CONDUIT / BACKBONE CABLING RISER DIAGRAM

FOR REFERENCE
PURPOSES ONLY

FOR REFERENCE PURPOSES ONLY

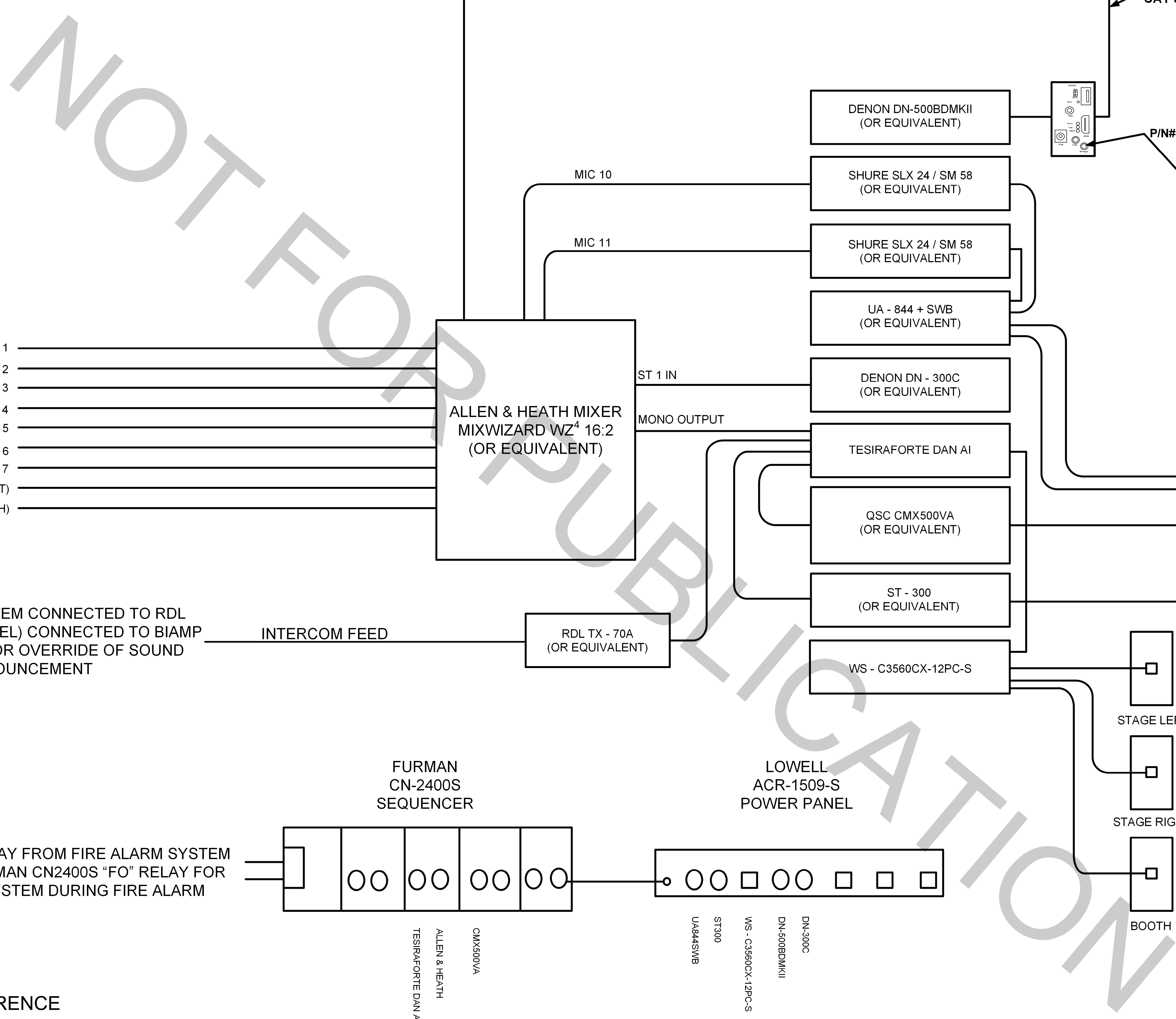

25V INPUT FROM INTERCOM SYSTEM CONNECTED TO RDL TX70A (CONVERTING TO LINE LEVEL) CONNECTED TO BIAMP TESIRAFORTE DAN AI INPUT #4 FOR OVERRIDE OF SOUND SYSTEM DURING INTERCOM ANNOUNCEMENT

NORMALLY CLOSED RELAY FROM FIRE ALARM SYSTEM CONNECTED TO THE FUMAN CN2400S "FO" RELAY FOR OVERRIDE OF SOUND SYSTEM DURING FIRE ALARM ACTIVATION

FOR REFERENCE PURPOSES ONLY

FOR REFERENCE PURPOSES ONLY

TYPICAL CAFETORIUM SOUND SYSTEM BLOCK DIAGRAM

FOR REFERENCE PURPOSES ONLY

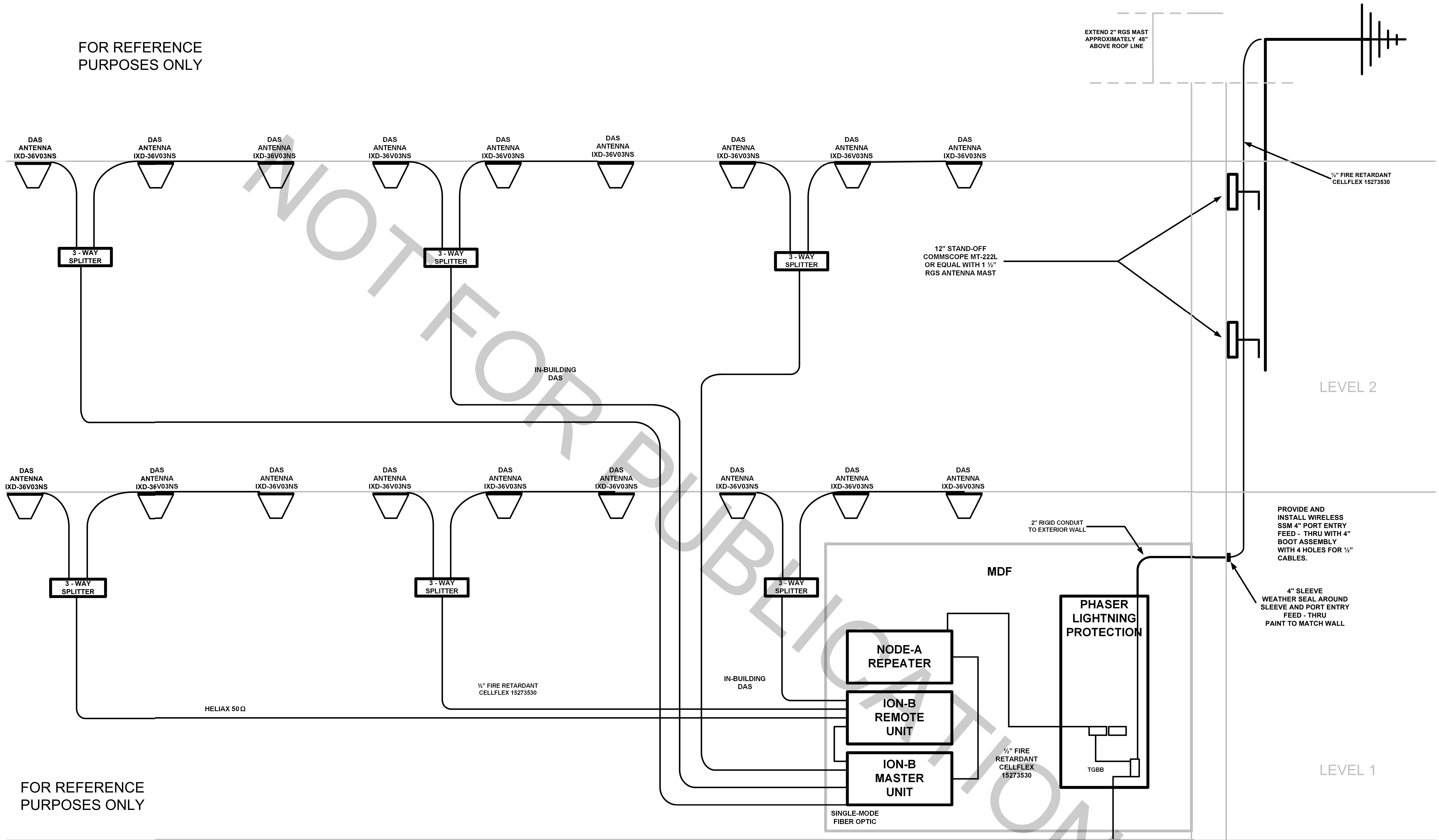

FOR REFERENCE PURPOSES ONLY

GENERAL DAS / EMS NOTES :

1. THIS BUILDING HAS A FIRE SPRINKLER SYSTEM.
2. ELEVATION OF THE HIGHEST OCCUPIED FLOOR IS APPROXIMATELY ---
3. NFPA 72 CODE FOLLOWED 24.5.2.5.1: EQUIPMENT IS POWERED BY 20A CIRCUIT.
4. NFPA 72 CODE FOLLOWED 24.5.2.5.2: SECONDARY POWER IS 12-HOUR AT 100% CAPACITY.
5. NFPA 72 CODE FOLLOWED 24.5.2.8.2: BDA, UPS (PROVIDED BY DAS INSTALLER) AND FIBER EQUIPMENT ALARMS ARE CONNECTED TO FIRE ALARM PANEL.
6. NFPA 72 CODE FOLLOWED 24.5.2.5.2: ALL ACTIVE BDA EQUIPMENT AND UPS IS ENCLOSED IN FIRE ENGINE RED NEMA ENCLOSURES
7. RISER HAS LEVEL 2 SURVIVABILITY PATHWAY FOR CABLE; ALL ROOMS CONTAINING EQUIPMENT IS 2-HOUR FIRE RATED.
8. TOTAL NUMBER OF DEVICES INSTALLED IN THE 800MHZ SYSTEM IS ---
9. THE ROOM ENCLOSING THE FACP, BOOSTER POWER SUPPLY AND BDA IS MECHANICALLY VENTILATED.
10. THE FACP AMPLIFIERS AND ASSOCIATED EQUIPMENT IS PROTECTED WITH SMOKE DETECTOR.
11. ALL EQUIPMENT IS CONNECTED TO A DEDICATED CIRCUIT BREAKER MARKED "BDA CIRCUIT" PER NFPA 72:10.5.5.2.1.
12. THE BDA SYSTEM IS EQUIPPED WITH FCC COMPLIANT CLASS "B" SIGNAL BOOSTER.
13. BDA IS LOCATED IN PLACE THAT MEETS ALL ENVIRONMENTAL CONTROLS.
14. THERE ARE AT LEAST 2 INDEPENDENT AND RELIABLE POWER SUPPLIES PER NFPA 72: 24.5.2.5.5.
15. BDA INSTALLED ARE FCC CERTIFIED AND COMPATIBLE WITH BOOTH ANALOG AND DIGITAL NFPA 72: 24.5.2.5.4.
16. THE INTEGRITY OF THE CIRCUIT MONITORING THE BDA COMPLIES WITH NFPA 72: 10.6.9.1.1.
17. THE BDA SYSTEM IS CAPABLE OF UPGRADE IN ACCORDANCE WITH NFPA 72: 10.6.9.
18. ALL CRITICAL AREAS AND GENERAL AREAS HAVE A MINIMUM OF 99% FLOOR AREA RADIO COVERAGE IN ACCORDANCE WITH NFPA 72: 24.5.2.2.1 AND 24.5.2.2.2.
19. THERE IS A MINIMUM INBOUND AND OUTBOUND SIGNAL OF -95dBm THROUGHOUT THE COVERAGE AREA.
20. ISOLATION BETWEEN THE DONOR AND INDOOR ANTENNAS EXCEEDS 15dB ABOVE THE SIGNAL BOOSTER GAIN.
21. THERE ARE NO PERMANENT FILTERS AND ATTACHMENTS TO THE BDA SYSTEM.
22. THERE IS A GRID SYSTEM OVERLYING ALL FLOORS IN ORDER TO IDENTIFY AREAS OF DEFICIENCIES WHEN TESTED.
23. ALL EXTERIOR ANTENNAS ARE HIGH GAIN, VERTICALLY POLARIZED AND SPECIFIED FOR OPERATING FREQUENCIES.
24. CONTRACTOR SHALL BE RESPONSIBLE FOR THE CORRECT LOCATIONS AND QUANTITIES OF THE OMNI COVERAGE ANTENNAS UPON COMPREHENSIVE RADIO FREQUENCY SURVEY AND FORMAL DESIGN REQUIRED FOR THE ENTIRE PUBLIC SAFETY DAS PROJECT TO FURNISH A COMPLETELY OPERATIONAL SYSTEM PER NFPA, IFC REGULATIONS AND THE LOCAL GOVERNMENT REQUIREMENTS.
25. CONTRACTOR SHALL BE RESPONSIBLE FOR MEETING ALL CONDITIONS OF THE PLANS AND SPECIFICATIONS FOR A COMPLETE AND OPERATIONAL SYSTEM.
26. CONTRACTOR TO PROVIDE AND INSTALL ALL EQUIPMENT, RACKS, AND CABINETS IDENTIFIED ON THE DRAWINGS OR IN THE SPECIFICATIONS.
27. CONTRACTOR TO GROUND ALL CABLE TRAY, RACKS, AND CABINETS AND BOLT ALL RACKS AND CABINETS TO THE FLOOR. SEE DETAIL SHEETS FOR ADDITIONAL REQUIREMENTS.
28. ALL ELECTRICAL POWER CONNECTION AND BUILDING GROUNDING SYSTEM BY DIVISION 26 CONTRACTOR.
29. CONTRACTOR SHALL UTILIZE BUILDING FIBER FOR DAS UPLINK.
30. NFPA 72 ISOLATION VALUE SHALL BE MET.
31. ALL ACTIVE EQUIPMENT SHALL NOT BE LOCATED ABOVE THE CEILING. PER NFPA TOP OF EQUIPMENT SHOULD BE AT 6' OR BELOW.

PROVIDE AND INSTALL 24" X 24" X 12" METAL ENCLOSURE WITH HINGED COVER. INSTALL PLYWOOD BACKBOARD FOR MOUNTING LIGHTNING PROTECTION AND TGBB. INSTALL ENCLOSURE ABOVE CEILING.

TIE TO BUILDING GROUNDING SYSTEM BY DIVISION 26

DAS RISER DIAGRAM (TYPICAL)

FOR REFERENCE PURPOSES ONLY

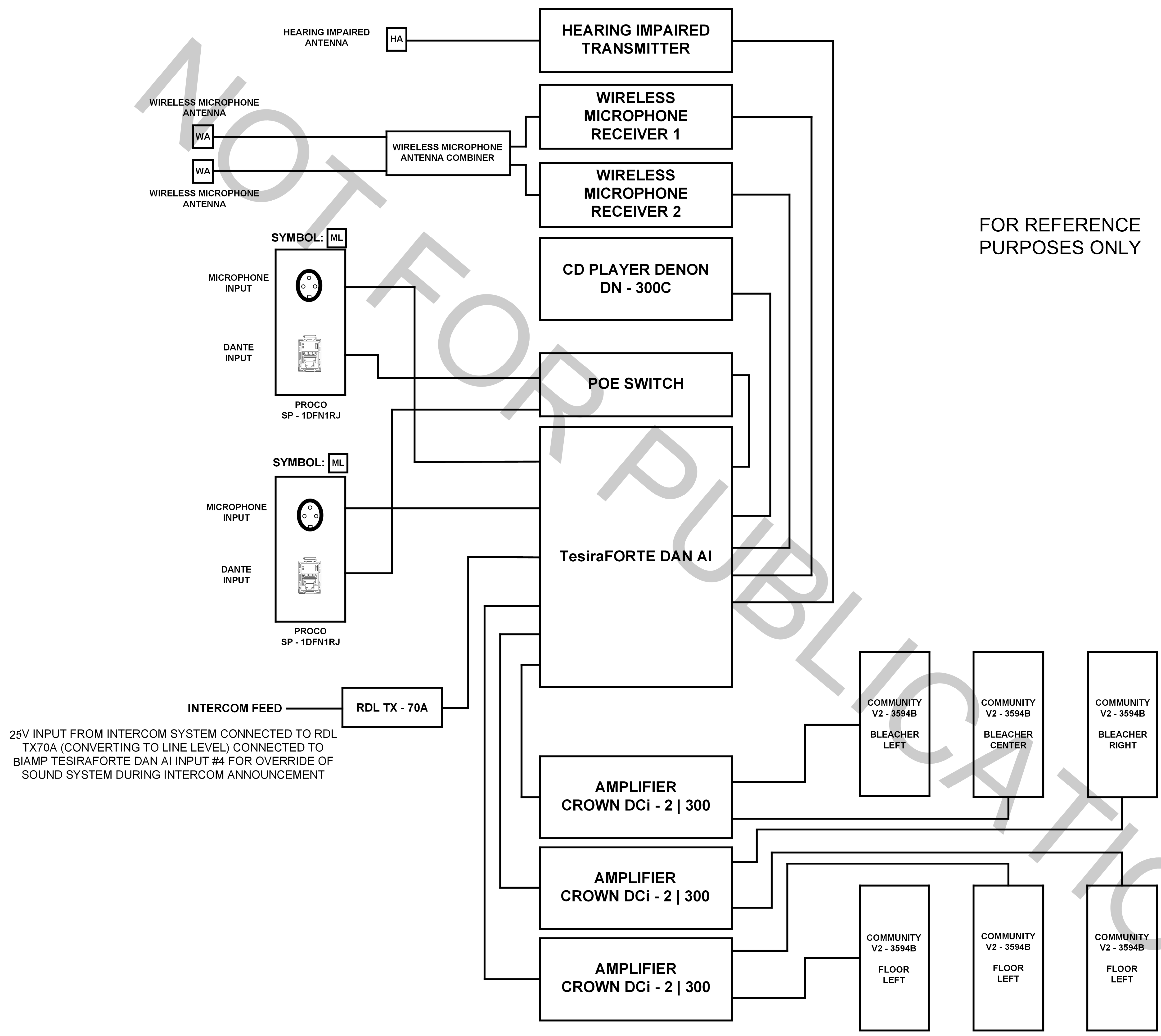

FOR REFERENCE PURPOSES ONLY

WALL MOUNT LOWELL LWR - 2123 WITH VENTED FRONT DOOR AND KEY LOCK

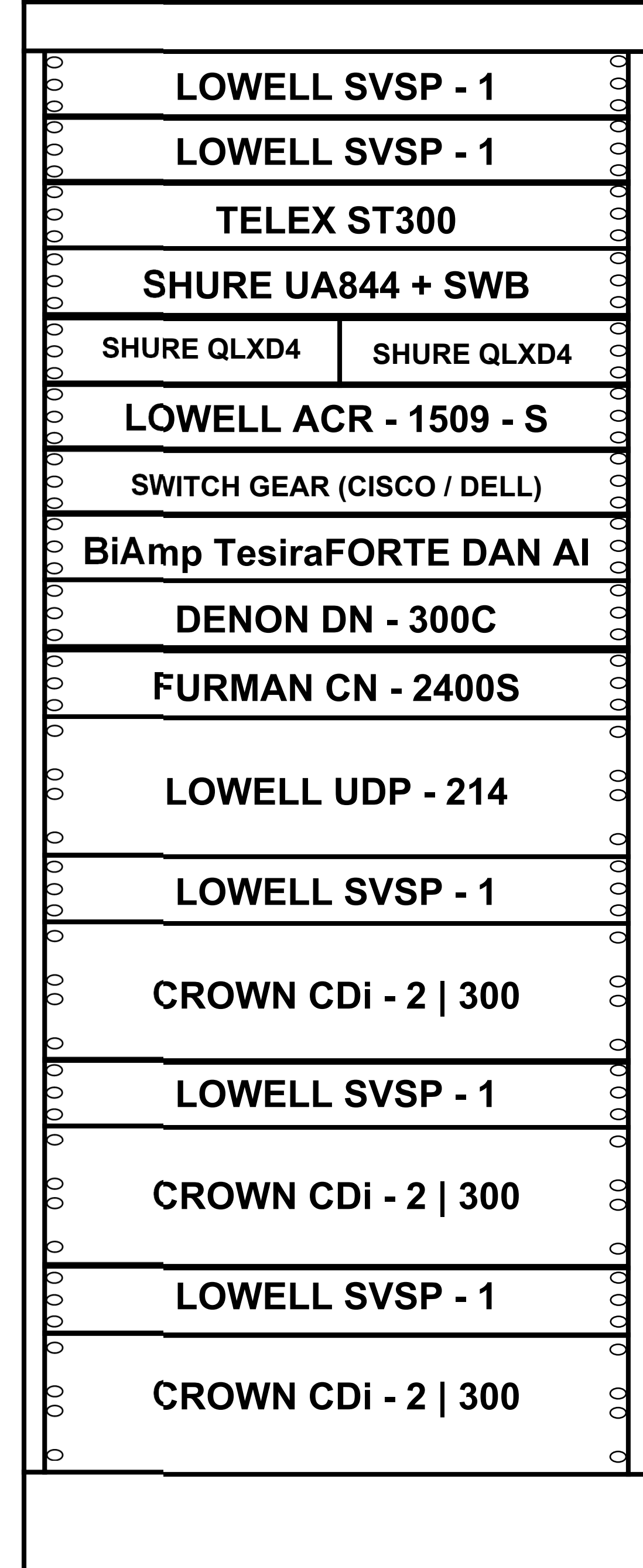

FOR REFERENCE PURPOSES ONLY

25V INPUT FROM INTERCOM SYSTEM CONNECTED TO RDL TX70A (CONVERTING TO LINE LEVEL) CONNECTED TO BIAMP TESIRAFORTE DAN AI INPUT #4 FOR OVERRIDE OF SOUND SYSTEM DURING INTERCOM ANNOUNCEMENT

ADDITIONAL COMPONENTS:

- (2) SHURE QLXD1 WIRELESS BODY PACK TRANSMITTERS
- (2) SHURE QLXD2 / SM58 HANDHELD WIRELESS MICROPHONE TRANSMITTERS
- (2) SHURE WL185 LAVALIER CONDENSER MICROPHONES
- (2) SHURE SM58S CARDIOID MICROPHONES
- (2) 25' XLR / UNBALANCED MICROPHONE CABLES
- (2) 50' XLR MICROPHONE CABLES
- (2) MICROPHONE STANDS
- (2) AUDINATE ADP-DAI-AU-2X0, DANTE AVIO INPUT ADAPTERS
- (2) RDL SF-BNC2, BI-DIRECTIONAL UNBALANCED STEREO AUDIO NETWORK INTERFACE

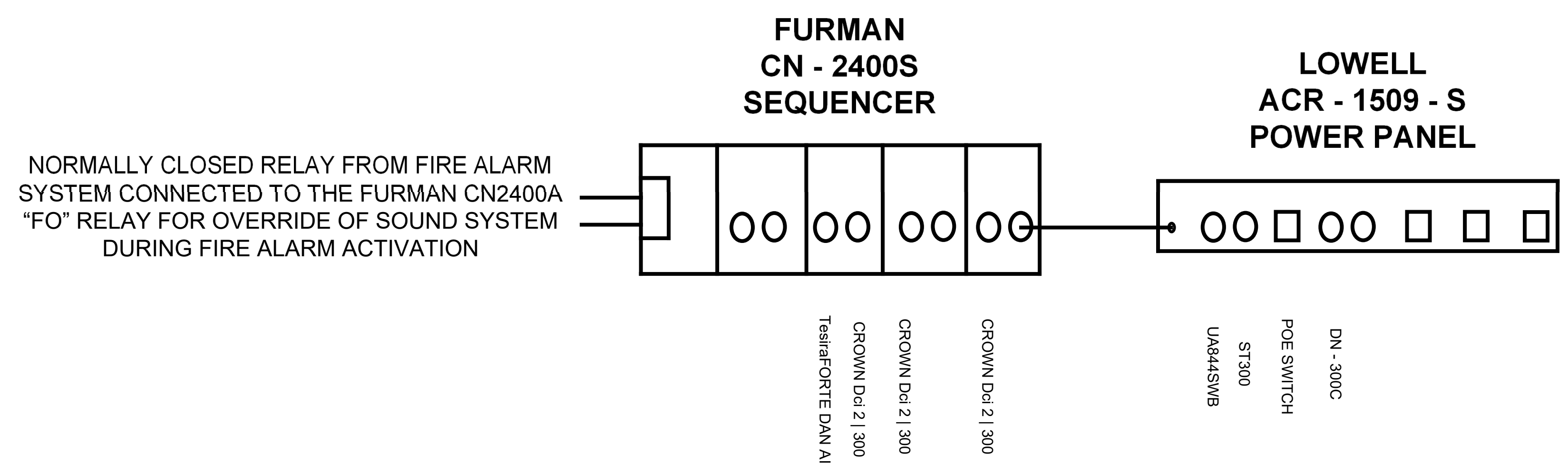

FOR REFERENCE PURPOSES ONLY

TYPICAL GYMNASIUM SOUND SYSTEM

NOT TO SCALE

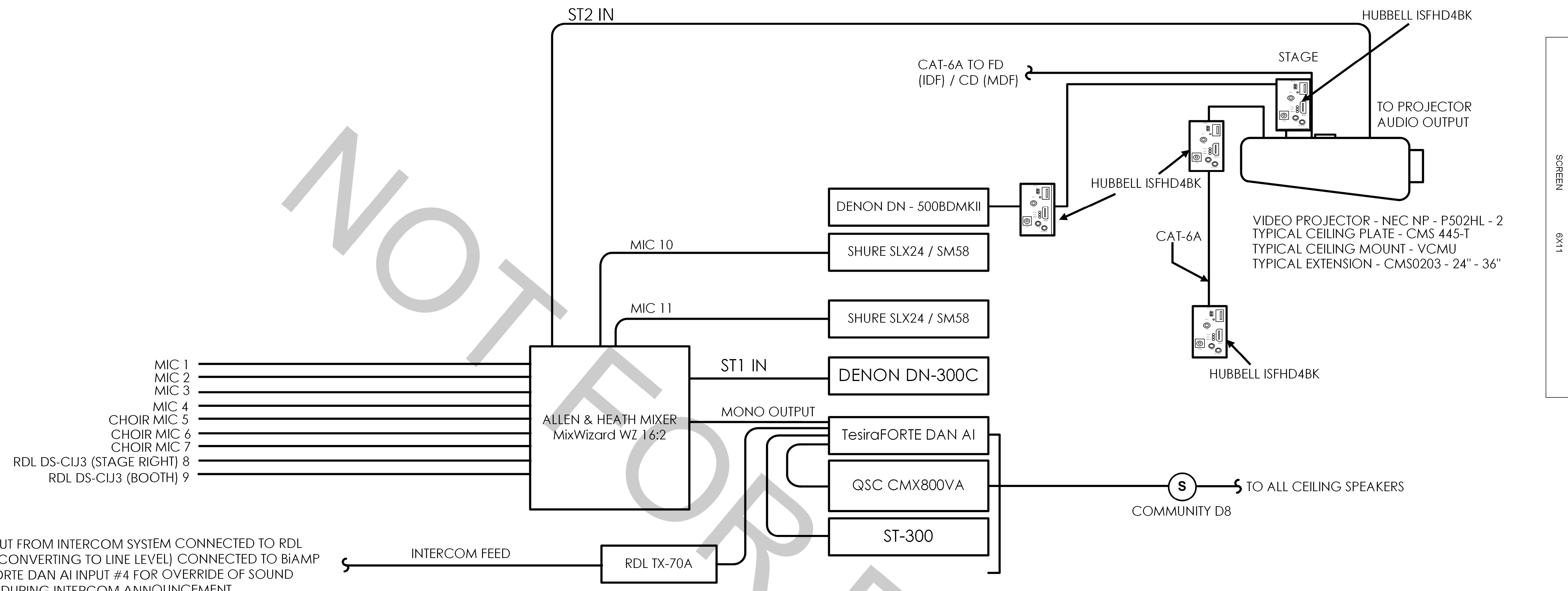

25V INPUT FROM INTERCOM SYSTEM CONNECTED TO RDL TX70A (CONVERTING TO LINE LEVEL) CONNECTED TO BIAMP TesiraFORTE DAN AI INPUT #4 FOR OVERRIDE OF SOUND SYSTEM DURING INTERCOM ANNOUNCEMENT

NORMALLY CLOSED RELAY FROM FIRE ALARM SYSTEM CONNECTED TO THE FURMAN CN2400S "FO" RELAY FOR OVERRIDE OF SOUND SYSTEM DURING FIRE ALARM ACTIVATION.

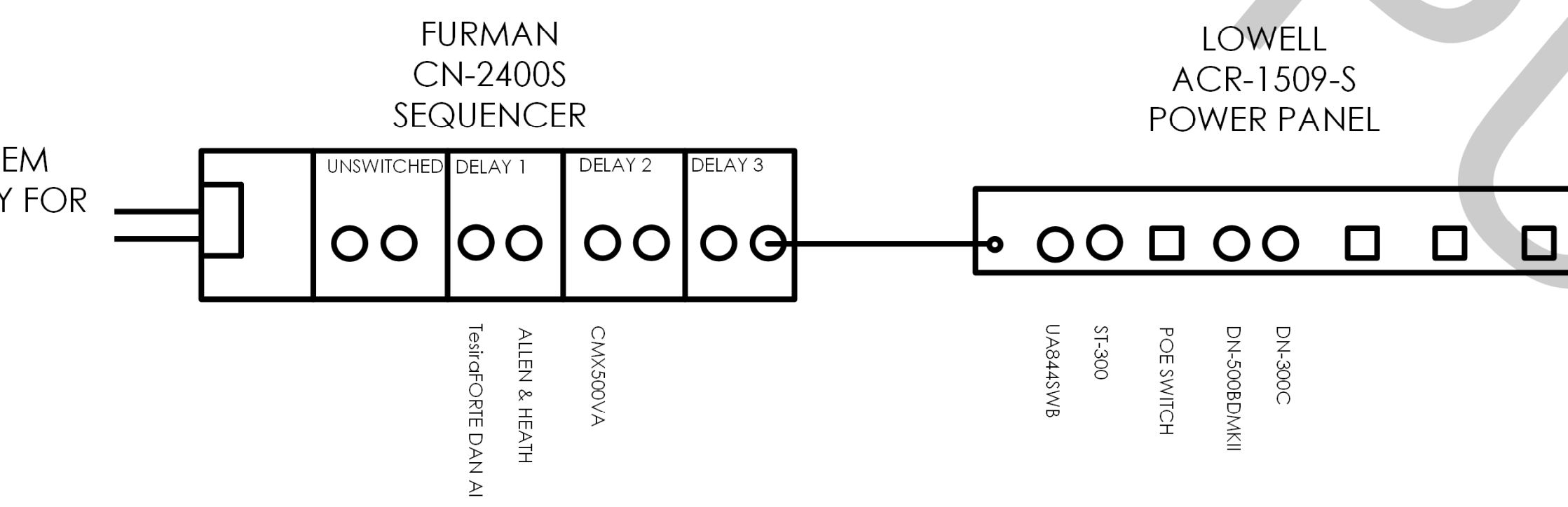

HIGH SCHOOL AUDIO / VISUAL SYSTEM LINE DIAGRAM

N.T.S

FOR REFERENCE PURPOSES ONLY

HIGH SCHOOL CAFETERIA AUDIO / VISUAL SYSTEM BLOCK DIAGRAM

FOR REFERENCE PURPOSES ONLY

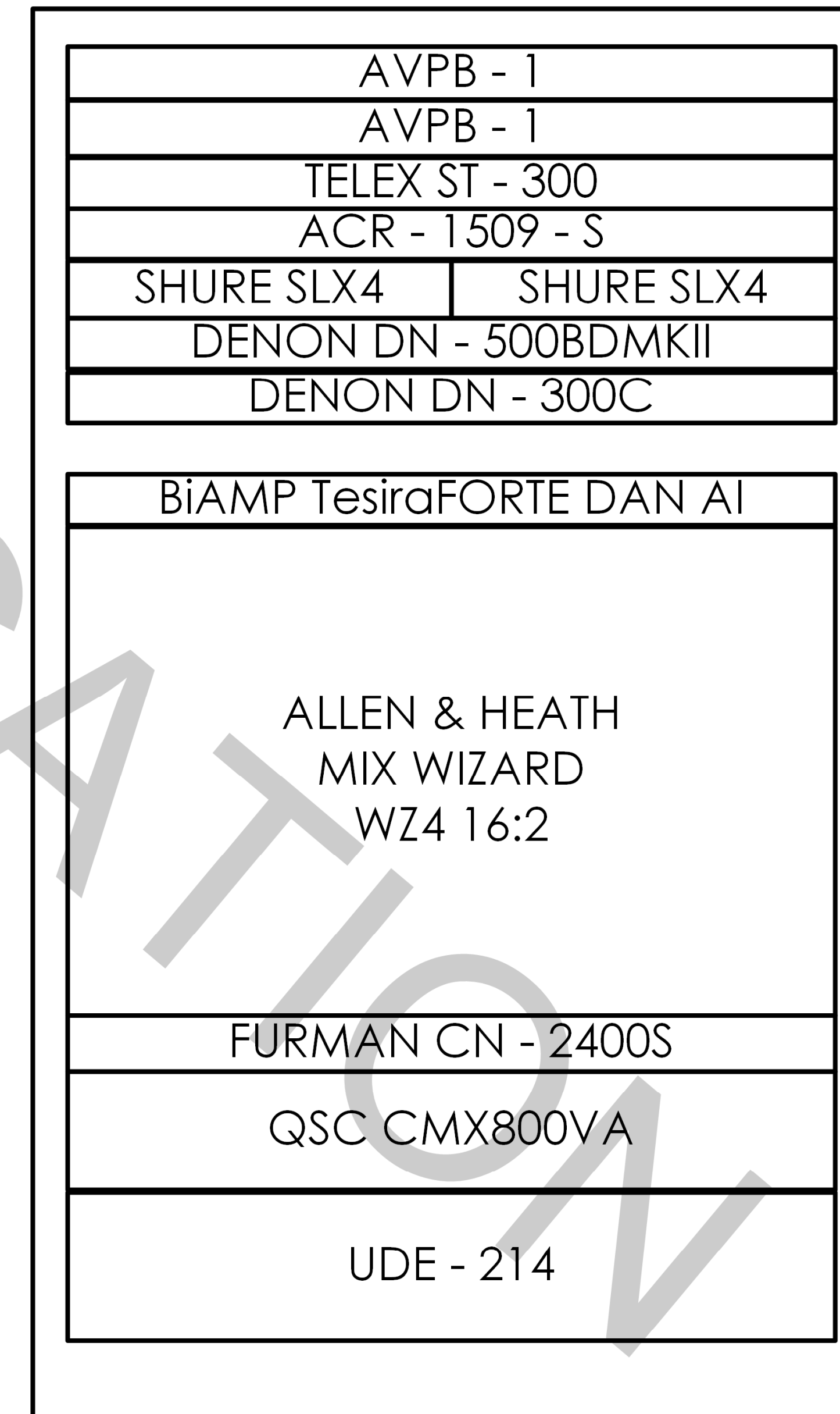

- VENT PANEL
- VENT PANEL
- HEARING IMPAIRED TRANSMITTER
- HORIZONTAL POWER DISTRIBUTION
- WIRELESS MICROPHONE RECEIVER SHURE SLX124 / 85 / SM58
- RACK MOUNT BLUE - RAY PLAYER
- RACK MOUNT CD / MEDIA PLAYER
- POE SWITCH FOR DANTE ADAPTERS
- DIGITAL AUDIO SERVER WITH 12 ANALOG INPUTS AND 8 ANALOG OUTPUTS

RACK MOUNT MIXER

3 STAGE POWER SEQUENCER

2000W 70V POWER AMP

2U UTILITY DRAWER

- ADDITIONAL COMPONENTS:
- (1) SHURE SLX2/SM58 WIRELESS MICROPHONES
 - (1) SHURE SM58S CARDIOID MICROPHONES
 - (1) BIAMP TEC-1s TESIRA POE ETHERNET CONTROL

LOWELL LWR - 2423 WITH LFD - 24FV VENTED FRONT DOOR AND KEY LOCK

HIGH SCHOOL AUDIO / VISUAL SYSTEM CABINET

N.T.S

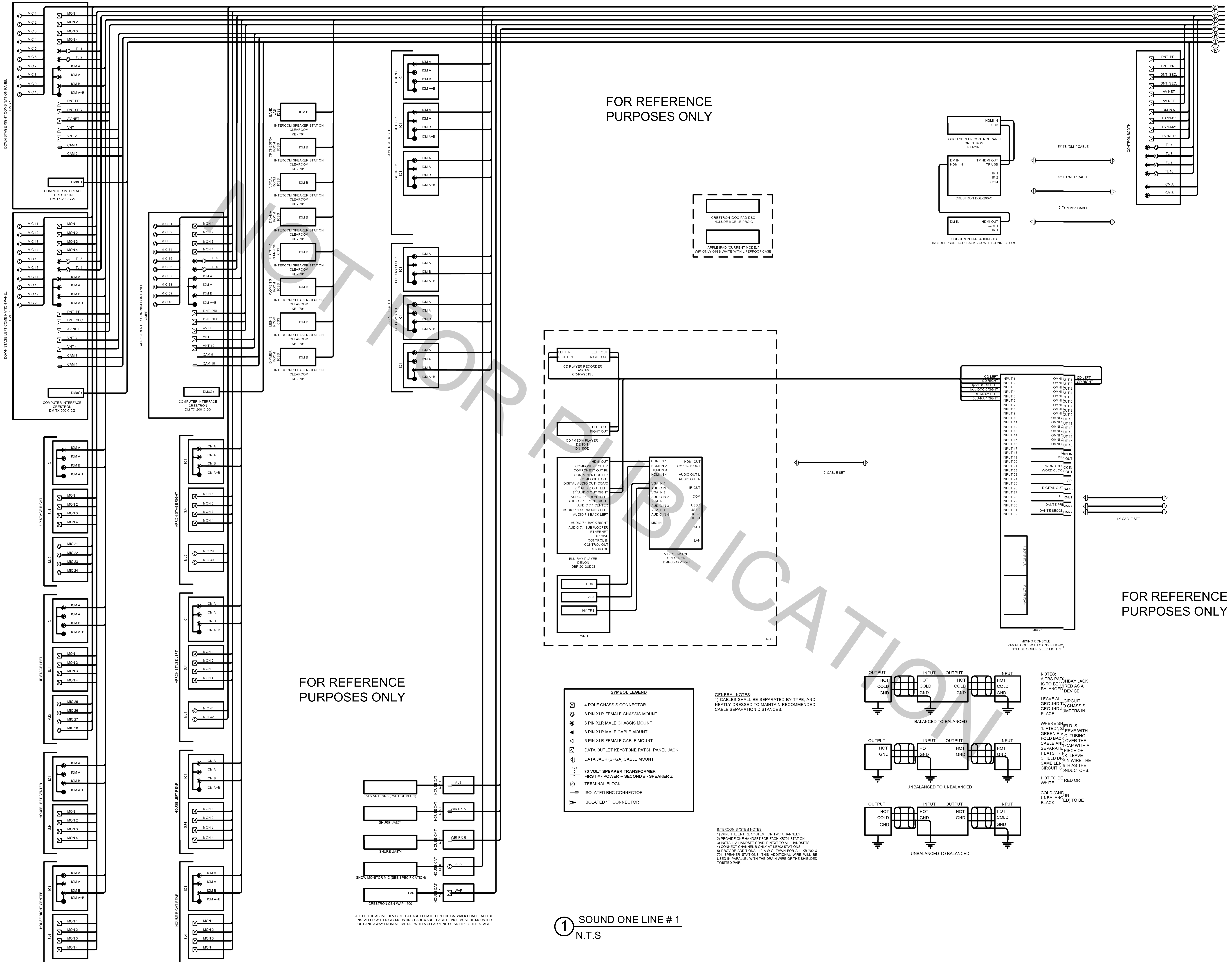

FOR REFERENCE PURPOSES ONLY

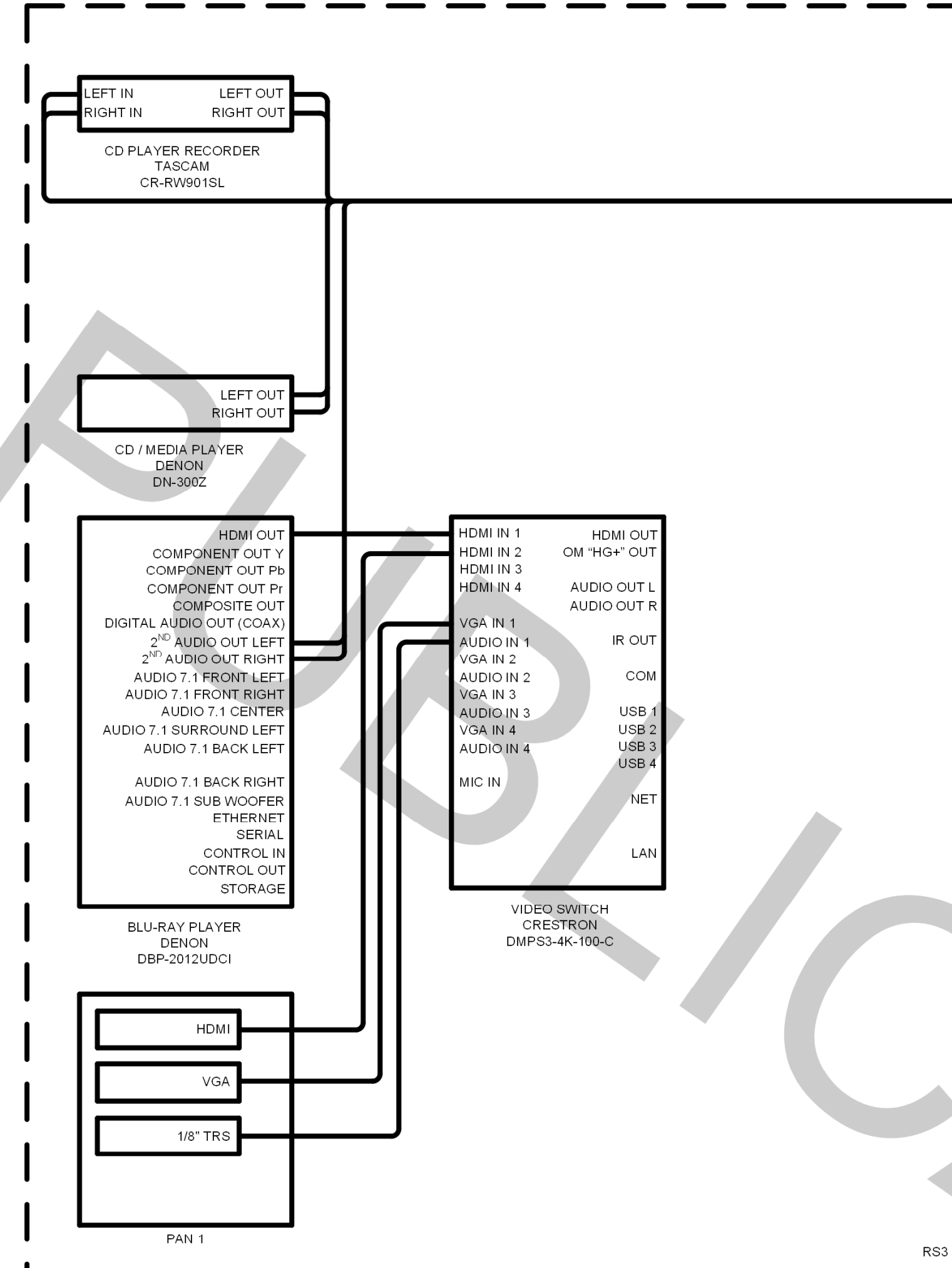
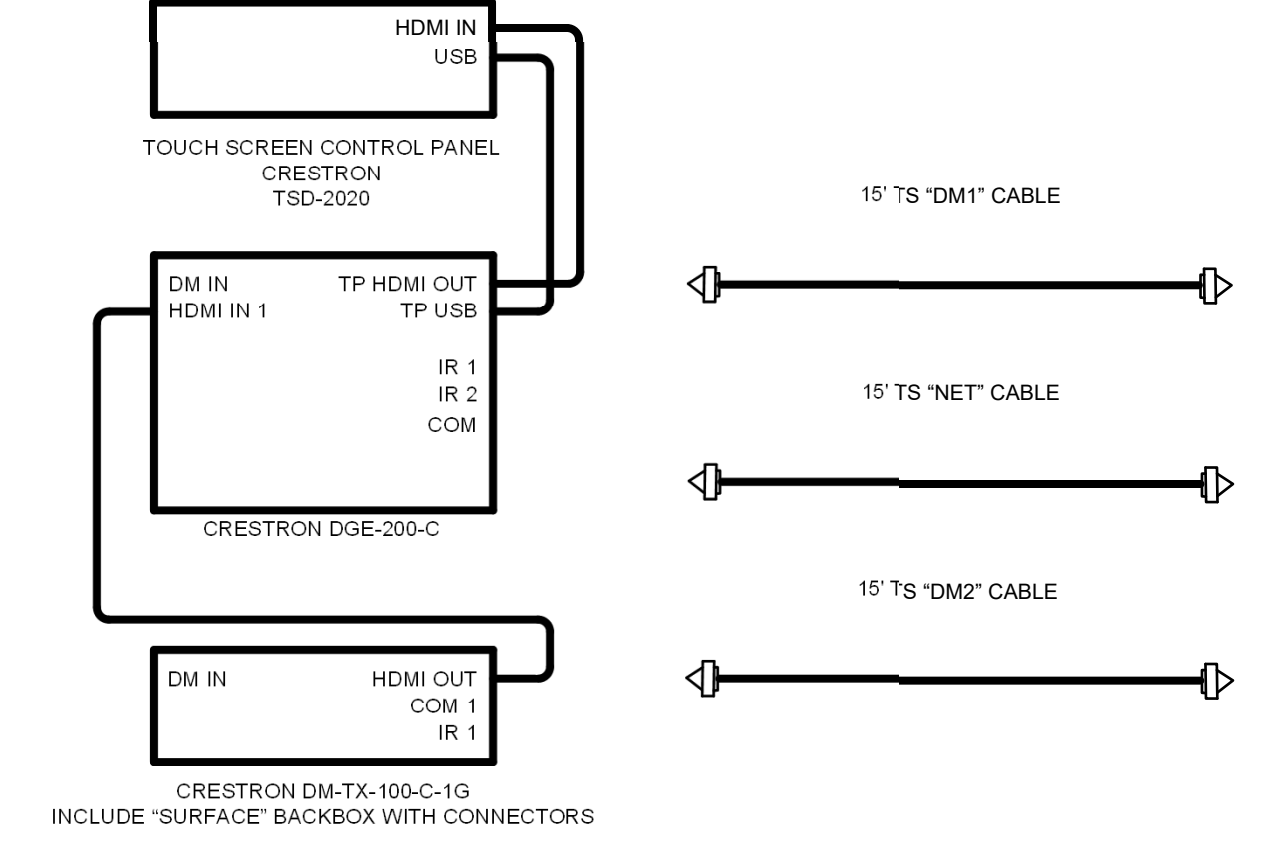
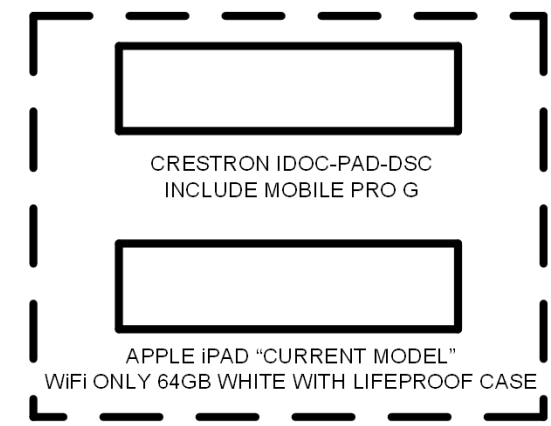

FOR REFERENCE PURPOSES ONLY

FOR REFERENCE PURPOSES ONLY

SYMBOL LEGEND

- 4 POLE CHASSIS CONNECTOR
- 3 PIN XLR FEMALE CHASSIS MOUNT
- 3 PIN XLR MALE CHASSIS MOUNT
- 3 PIN XLR MALE CABLE MOUNT
- 3 PIN XLR FEMALE CABLE MOUNT
- DATA OUTLET KEYSTONE PATCH PANEL JACK
- DATA JACK (PSGA) CABLE MOUNT
- 70 VOLT SPEAKER TRANSFORMER
FIRST # - POWER - SECOND # - SPEAKER Z
- TERMINAL BLOCK
- ISOLATED BNC CONNECTOR
- ISOLATED 'F' CONNECTOR

GENERAL NOTES:
 1) CABLES SHALL BE SEPARATED BY TYPE AND NEATLY DRESSED TO MAINTAIN RECOMMENDED CABLE SEPARATION DISTANCES.

INTERCOM SYSTEM NOTES:
 1) WIRE THE ENTIRE SYSTEM FOR TWO CHANNELS
 2) PROVIDE ONE HANDSET NEXT TO ALL HANDSETS
 3) INSTALL A HANDSET CRADLE NEXT TO ALL HANDSETS
 4) CONNECT CHANNEL B ONLY AT KEYTO STATIONS
 5) PROVIDE ADDITIONAL 1/2 A.W.G. THINWIRE FOR ALL KB-702 & 701 SPEAKER STATIONS. THIS ADDITIONAL WIRE WILL BE USED IN PARALLEL WITH THE DRAIN WIRE OF THE SHIELDED TWISTED PAIR.

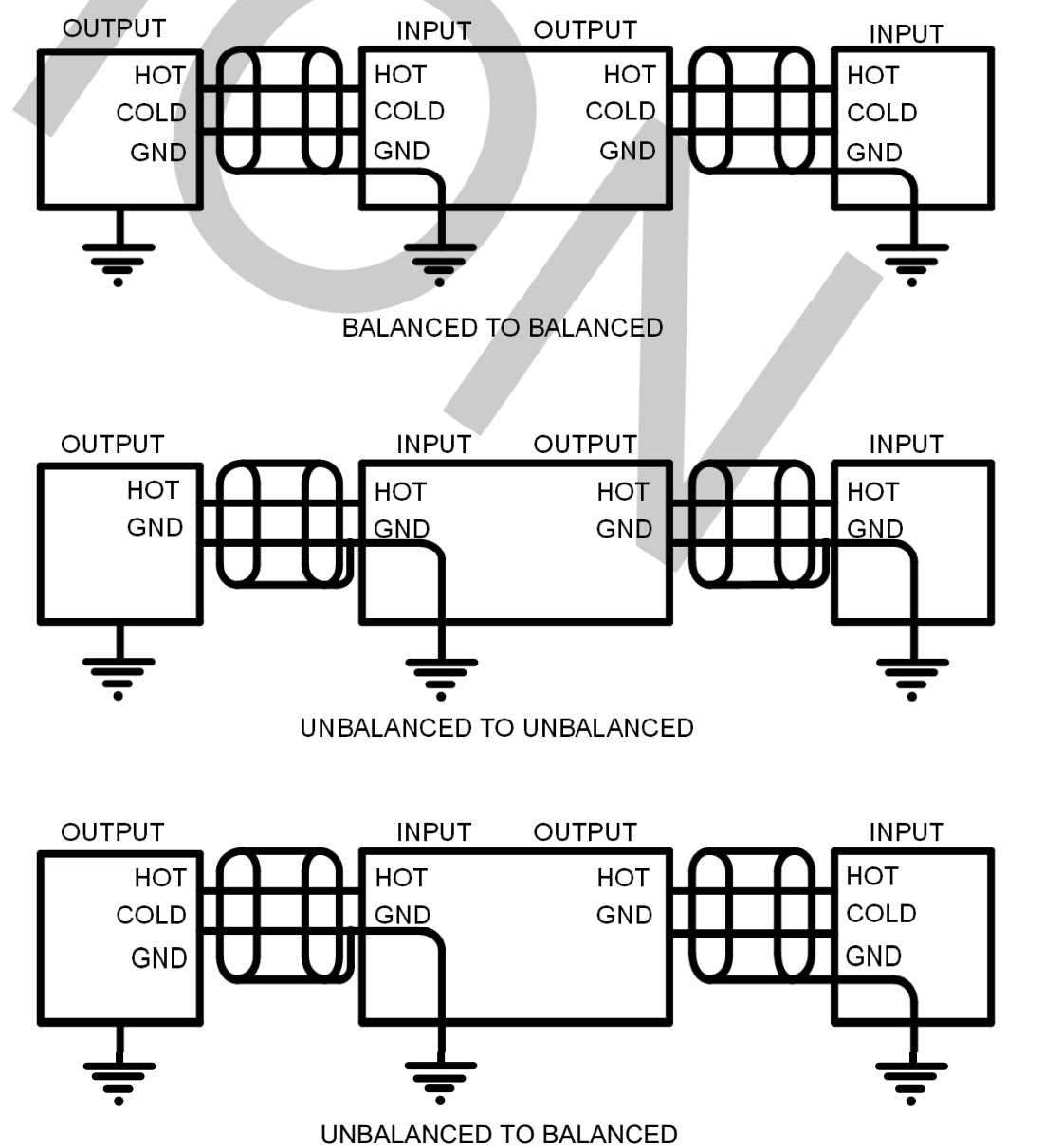

NOTES:
 A TRS PATCHBAY JACK IS TO BE WIRED AS A BALANCED DEVICE.
 LEAVE ALL CIRCUIT GROUND TO CHASSIS GROUND JUMPERS IN PLACE.
 WHERE SHIELD IS 'LIFTED' SLEEVE WITH GREEN P.V.C. TUBING FOLD BACK OVER THE CABLE AND SEPARATE CAP WITH A HEATSHRINK LEAVE SAME LENGTH AS THE CIRCUIT CONDUCTORS.
 HOT TO BE RED OR WHITE.
 COLD (GND IN UNBALANCED) TO BE BLACK.

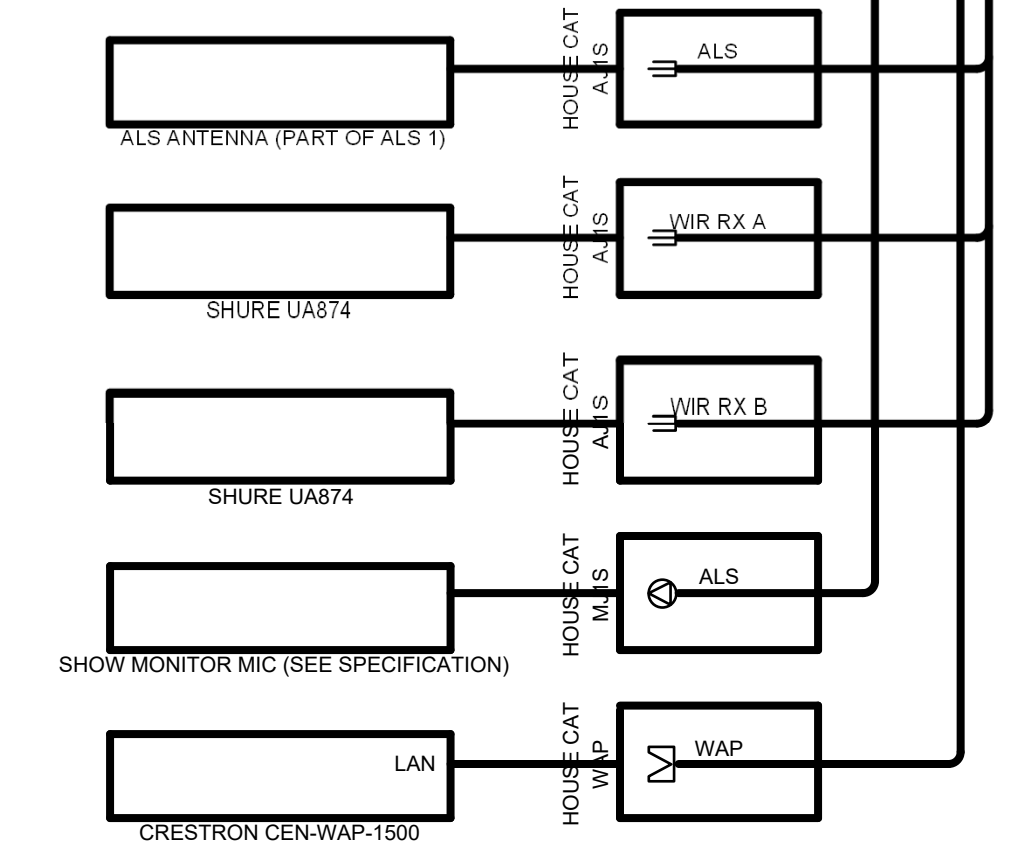

ALL OF THE ABOVE DEVICES THAT ARE LOCATED ON THE CATWALK SHALL EACH BE INSTALLED WITH RIGID MOUNTING HARDWARE. EACH DEVICE MUST BE MOUNTED OUT AND AWAY FROM ALL METAL, WITH A CLEAR LINE OF SIGHT TO THE STAGE.

1 SOUND ONE LINE #1
 N.T.S

FOR REFERENCE PURPOSES ONLY

FOR REFERENCE PURPOSES ONLY

FOR REFERENCE PURPOSES ONLY

1 SOUND ONE LINE # 2 N.T.S

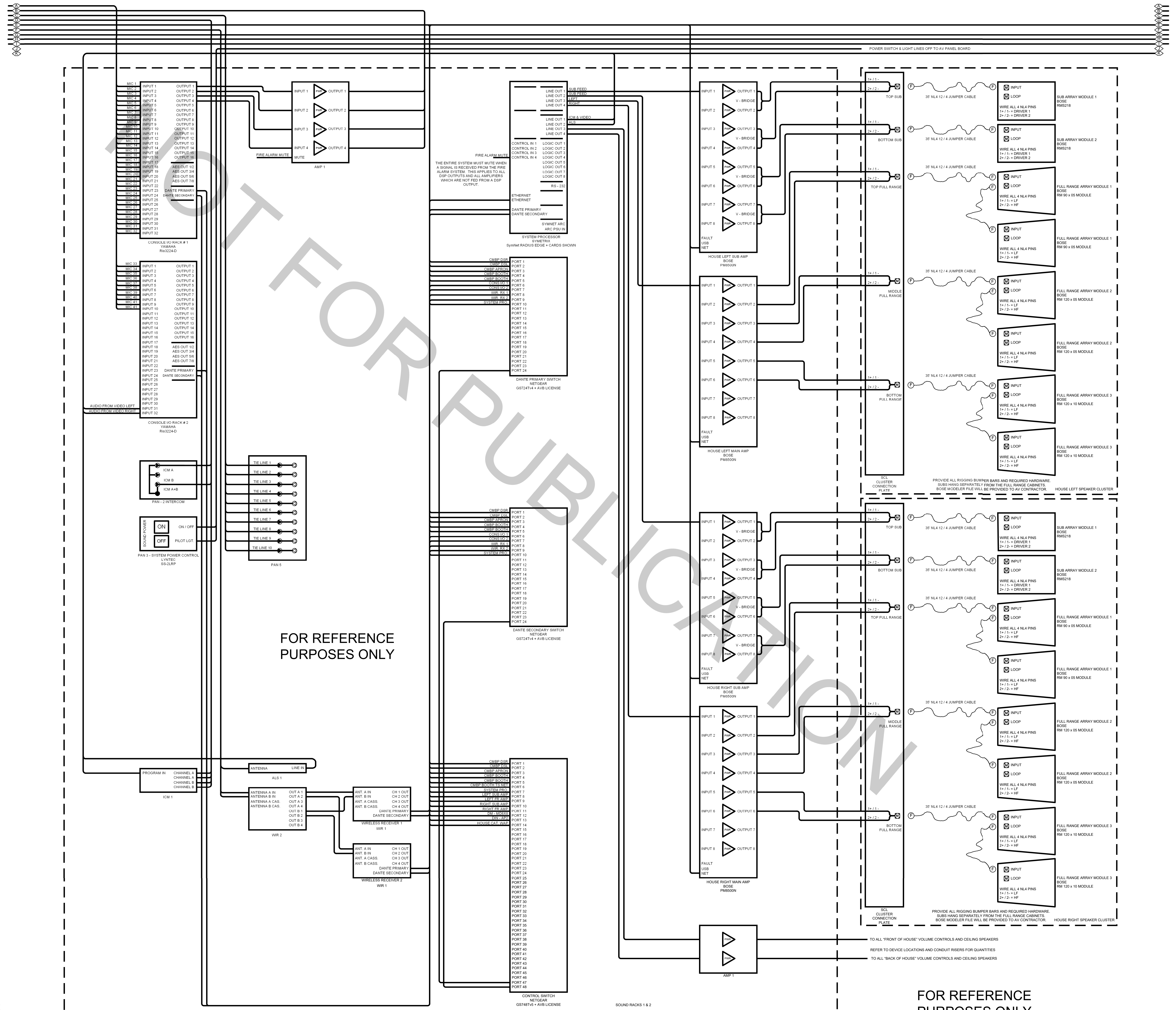

SOUND RACKS 1 & 2

TO ALL "FRONT OF HOUSE" VOLUME CONTROLS AND CEILING SPEAKERS
REFER TO DEVICE LOCATIONS AND CONDUIT RISERS FOR QUANTITIES
TO ALL "BACK OF HOUSE" VOLUME CONTROLS AND CEILING SPEAKERS

FOR REFERENCE
PURPOSES ONLY

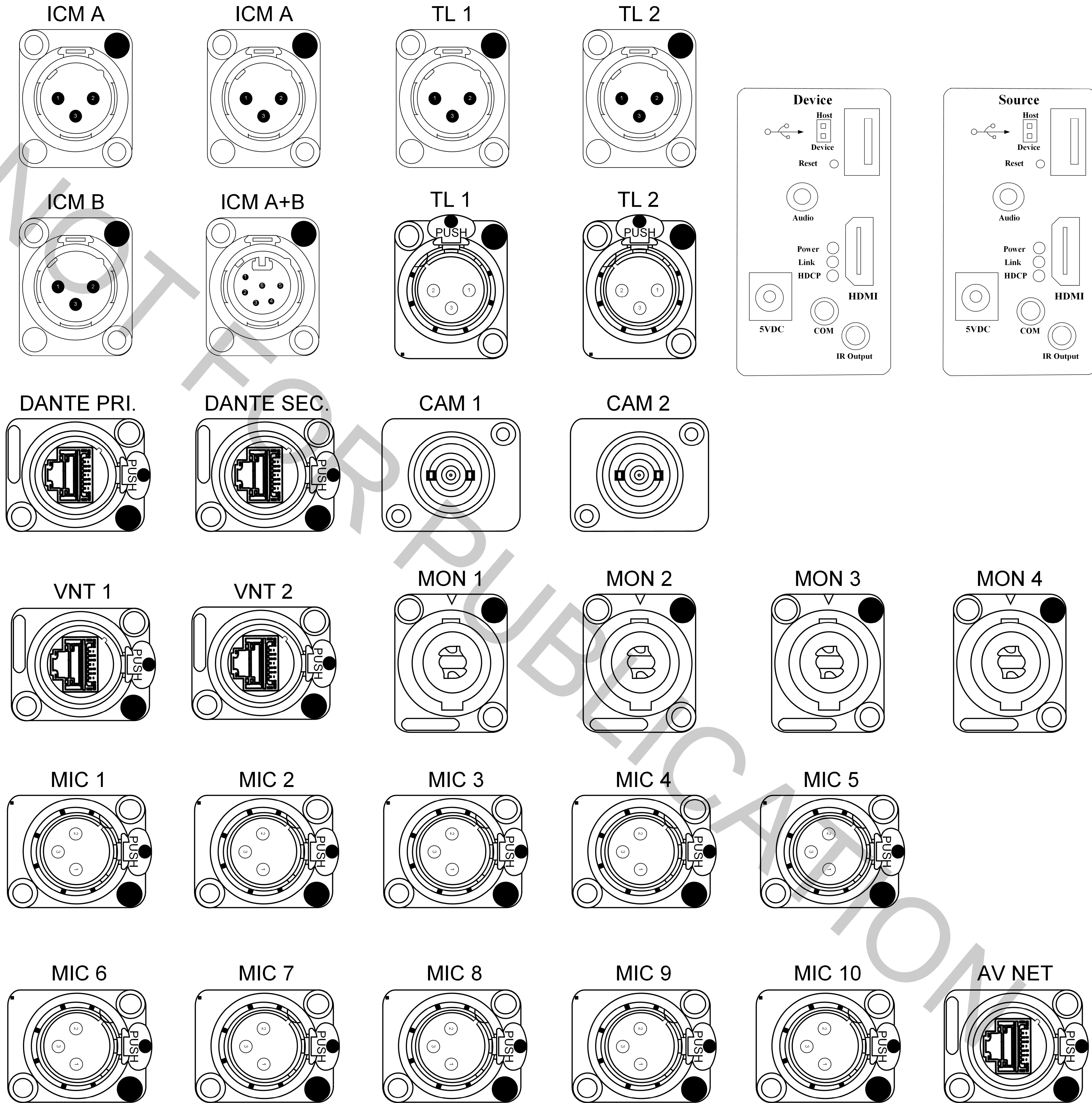

FOR REFERENCE
PURPOSES ONLY

FOR REFERENCE
PURPOSES ONLY

DOWN STAGE RIGHT COMBINATION PANEL "CMBP"

NOT TO SCALE

FOR REFERENCE
PURPOSES ONLY

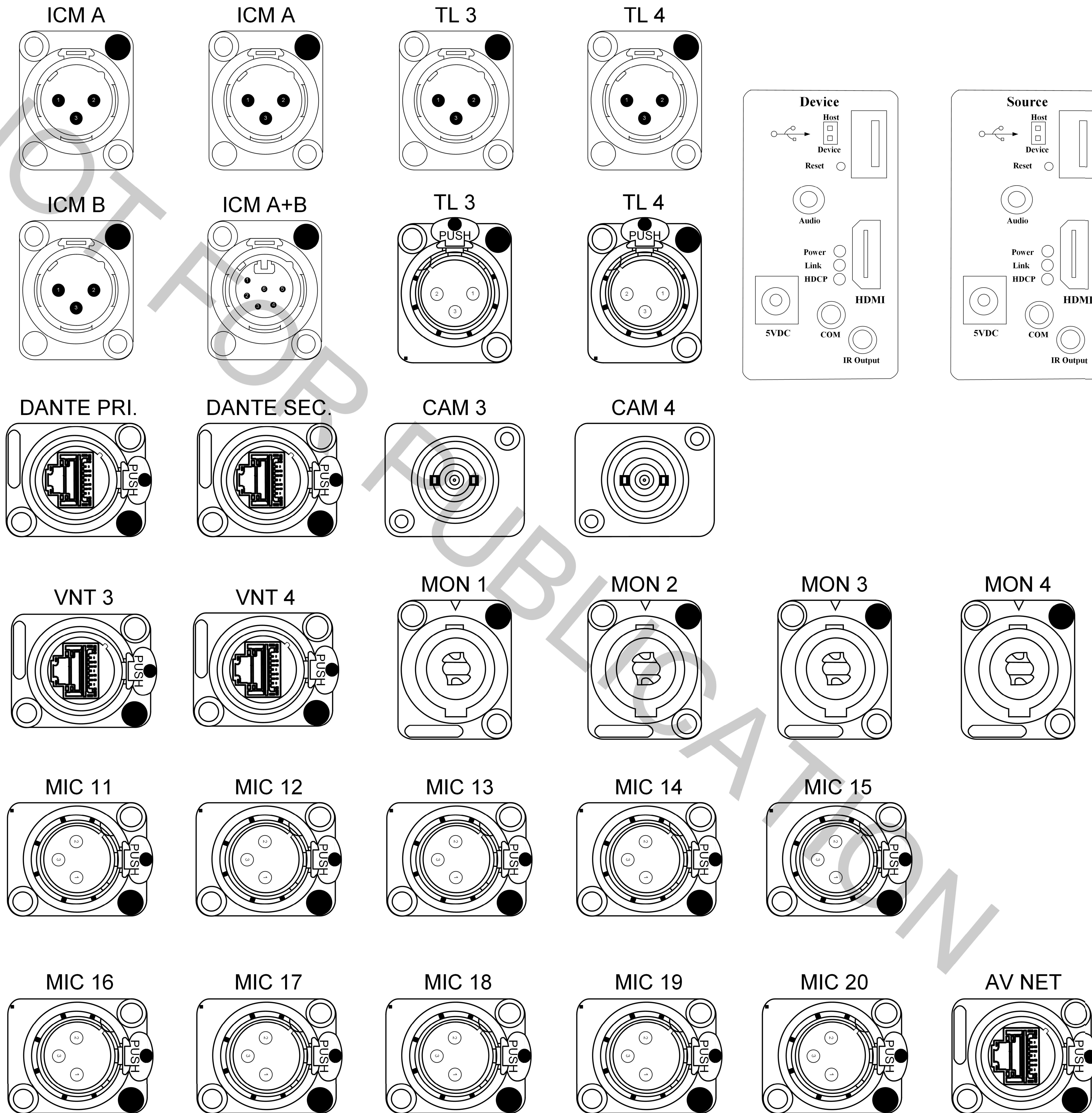

FOR REFERENCE
PURPOSES ONLY

FOR REFERENCE
PURPOSES ONLY

DOWN STAGE LEFT COMBINATION PANEL "CMBP"

NOT TO SCALE

FOR REFERENCE
PURPOSES ONLY

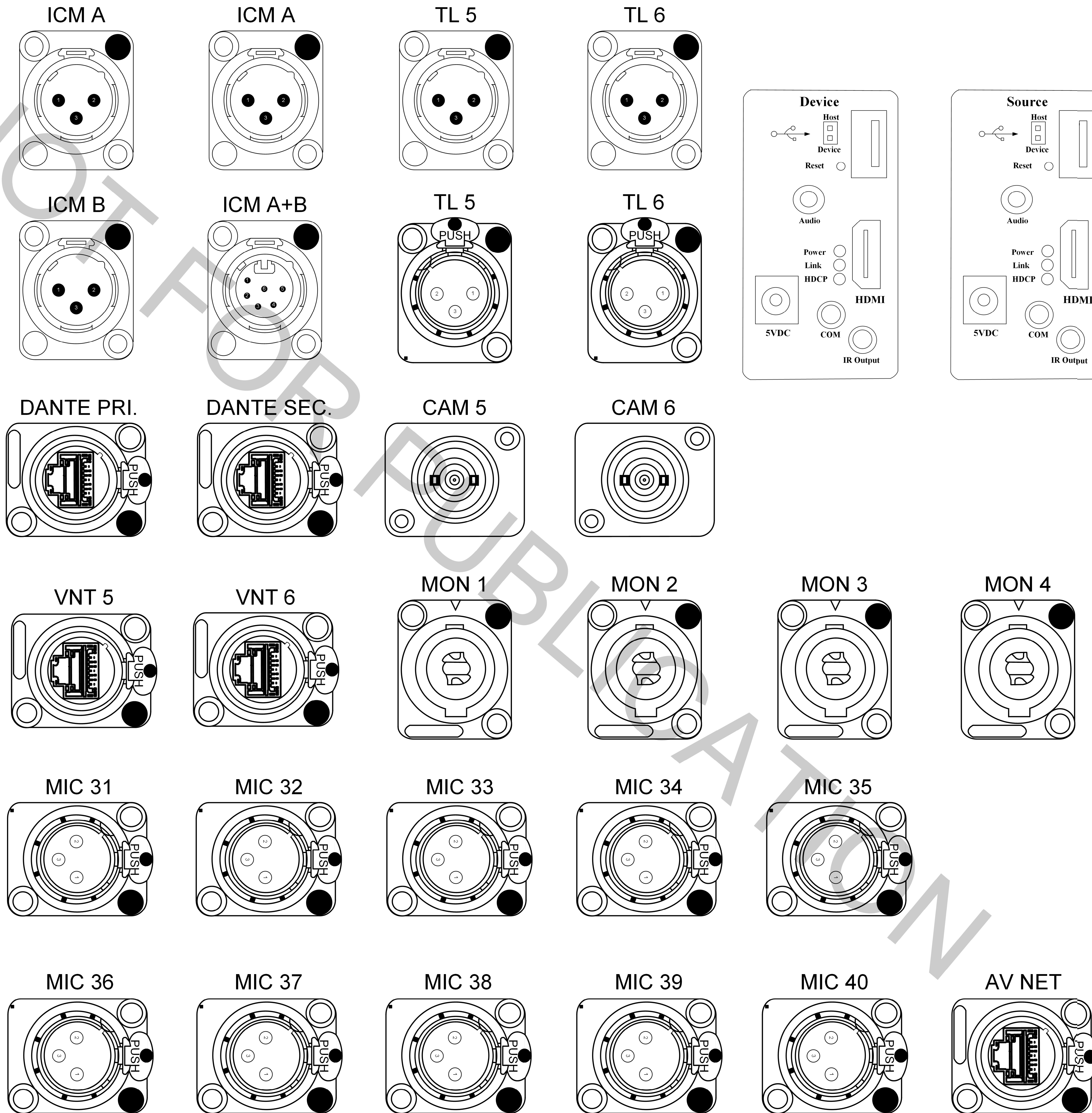

FOR REFERENCE
PURPOSES ONLY

FOR REFERENCE
PURPOSES ONLY

APRON CENTER "CMBP"

NOT TO SCALE

FOR REFERENCE
PURPOSES ONLY

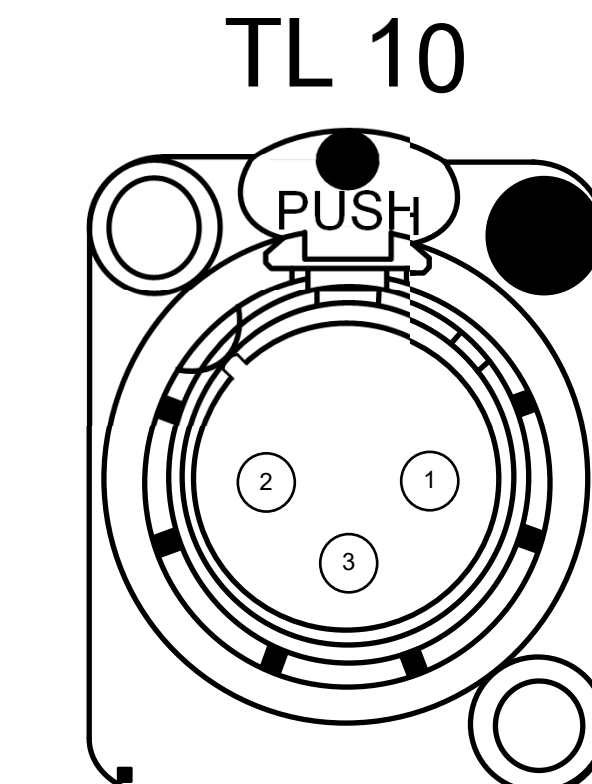
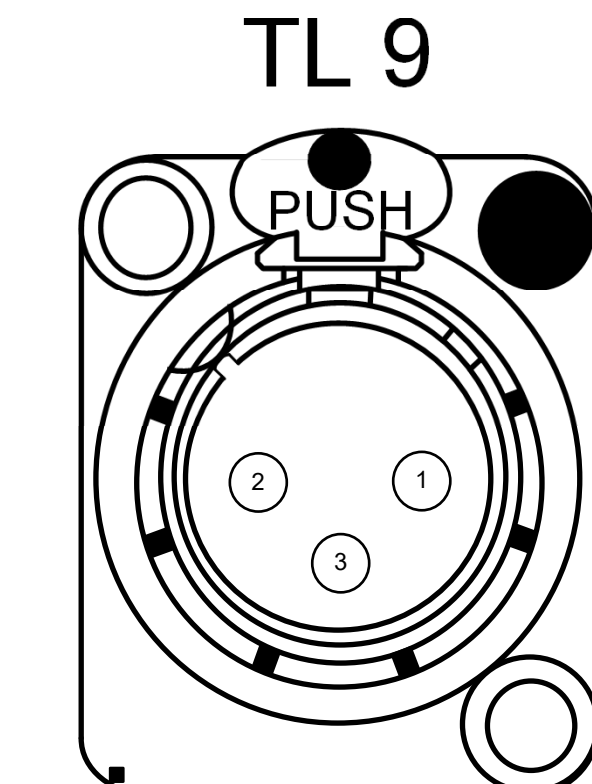
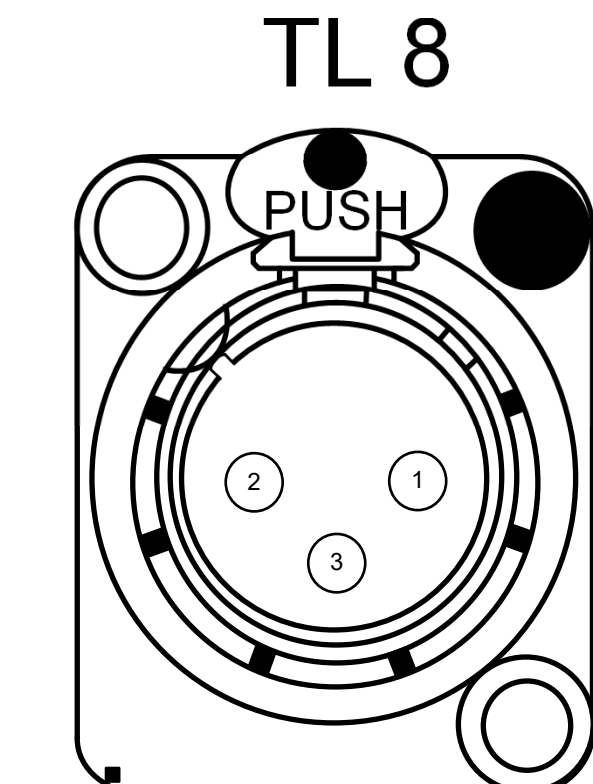
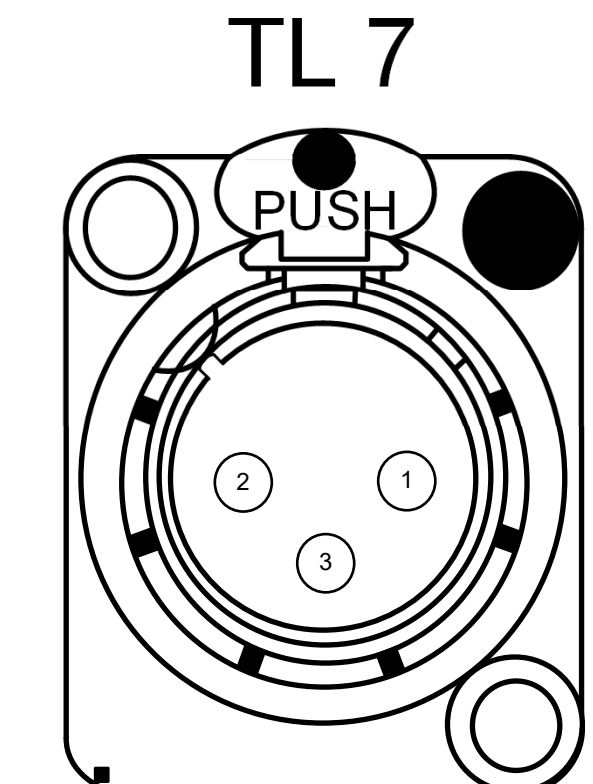
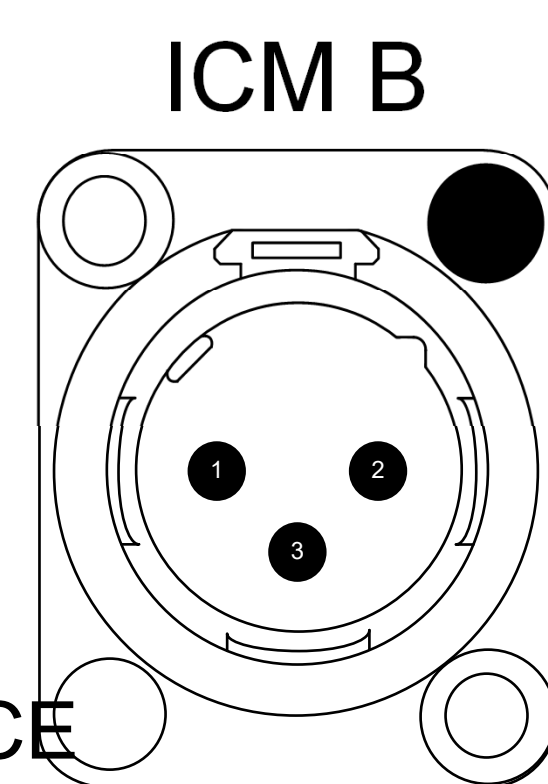
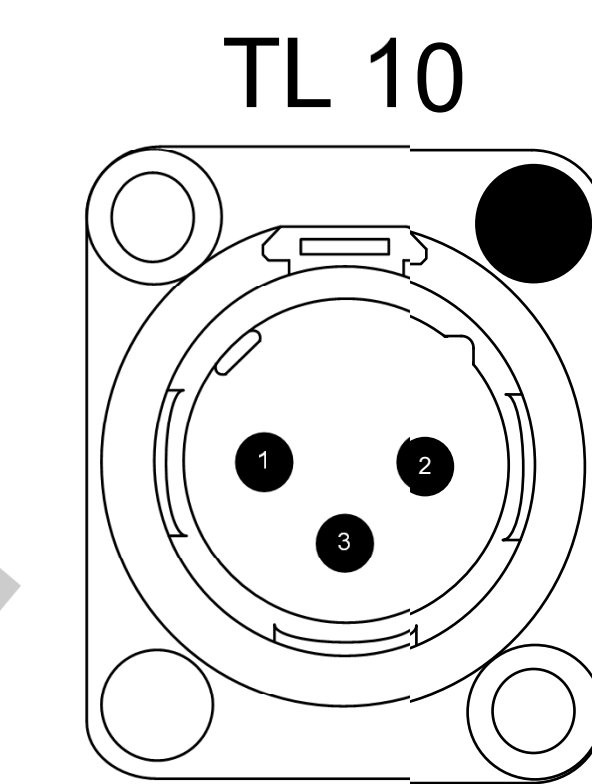
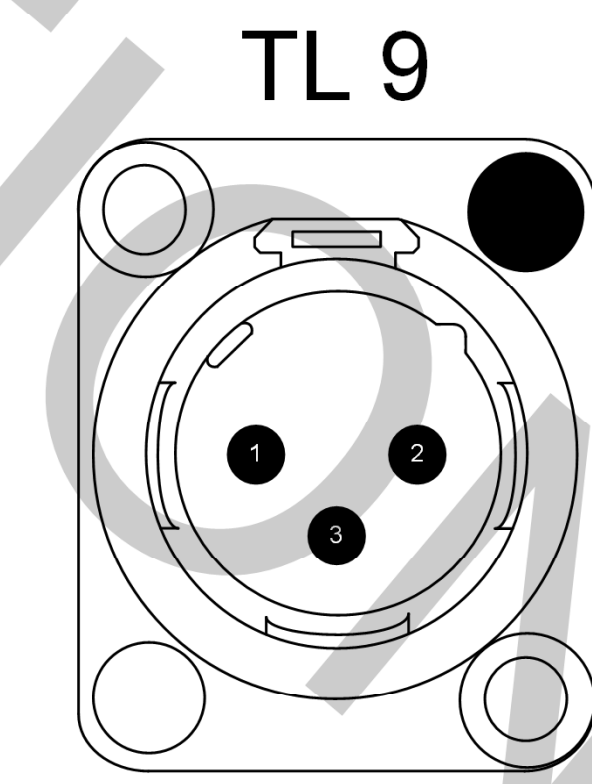
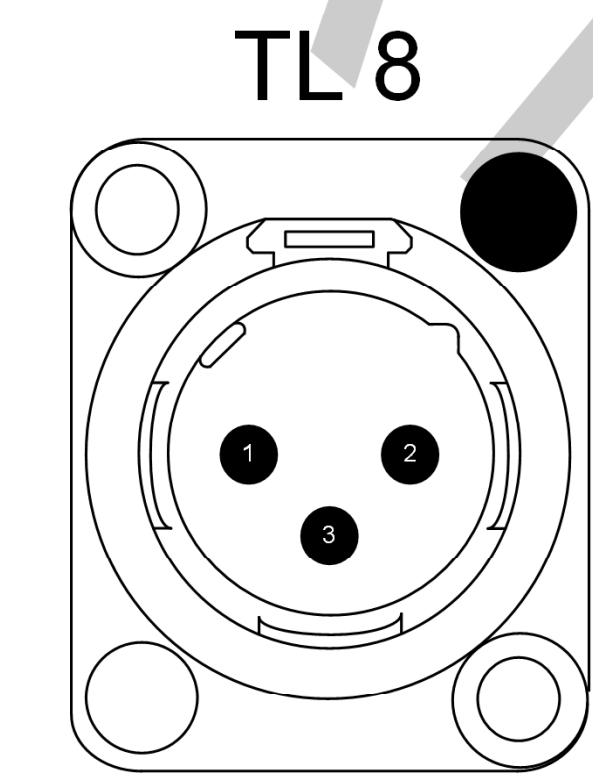
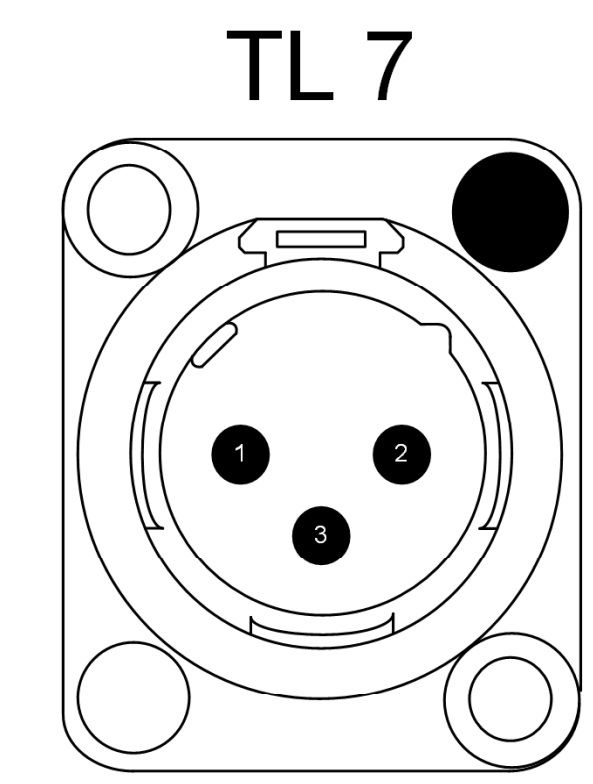
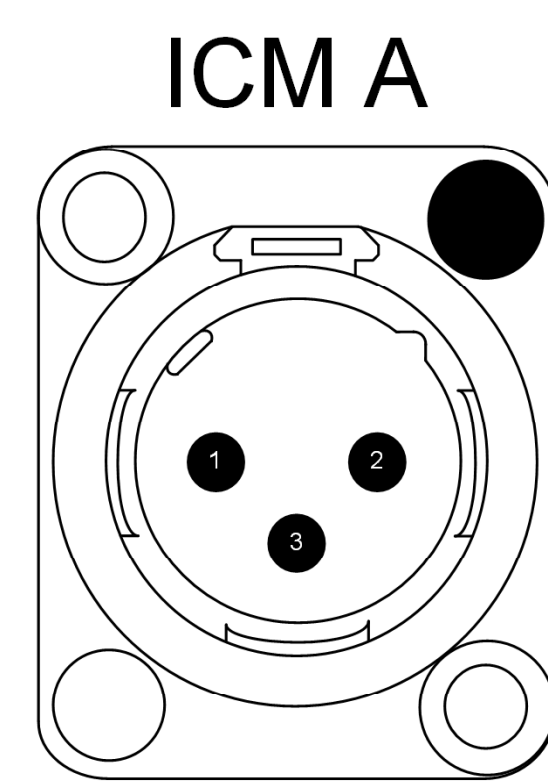
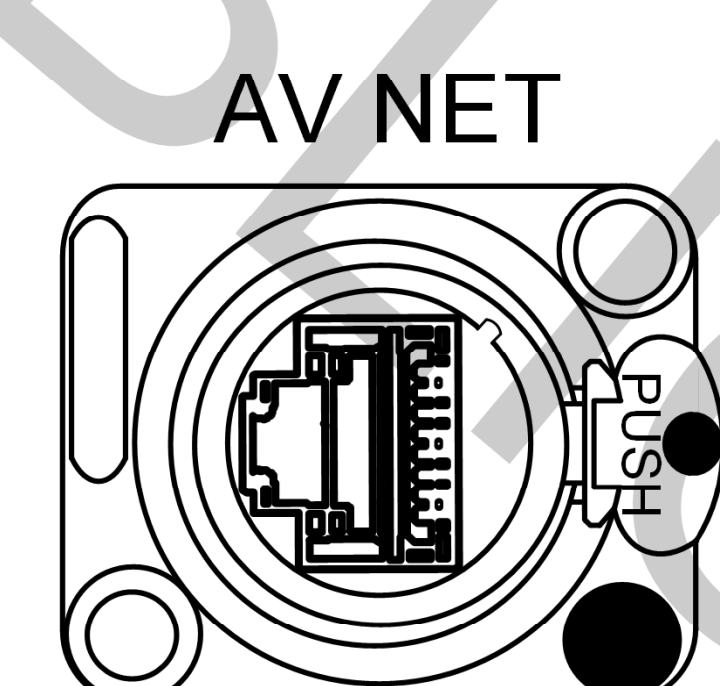
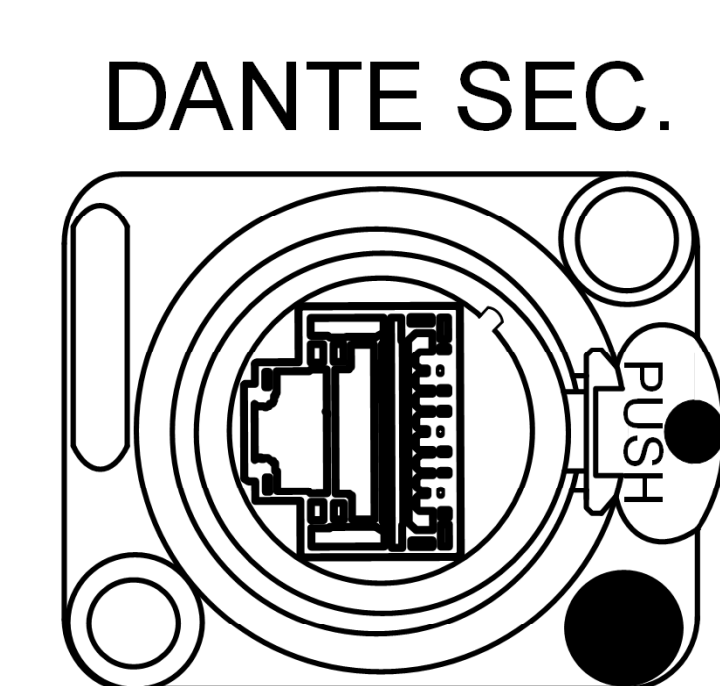
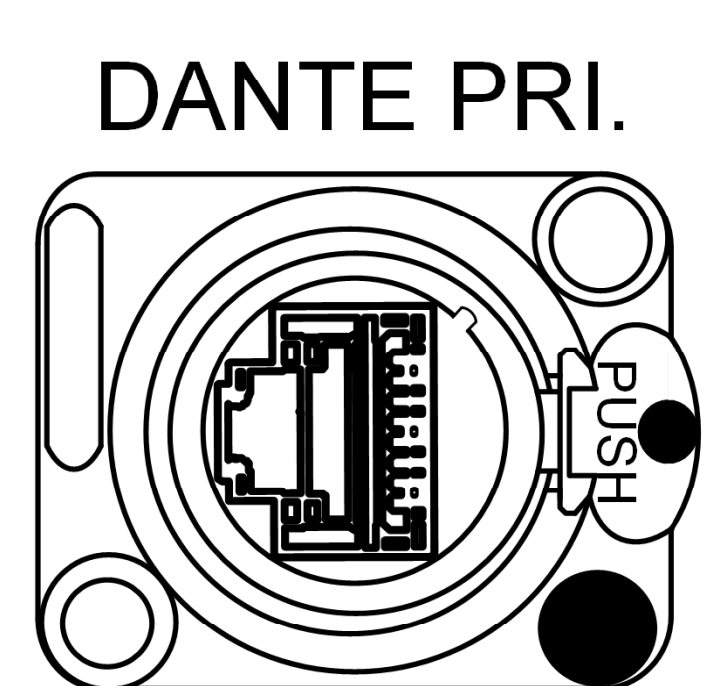
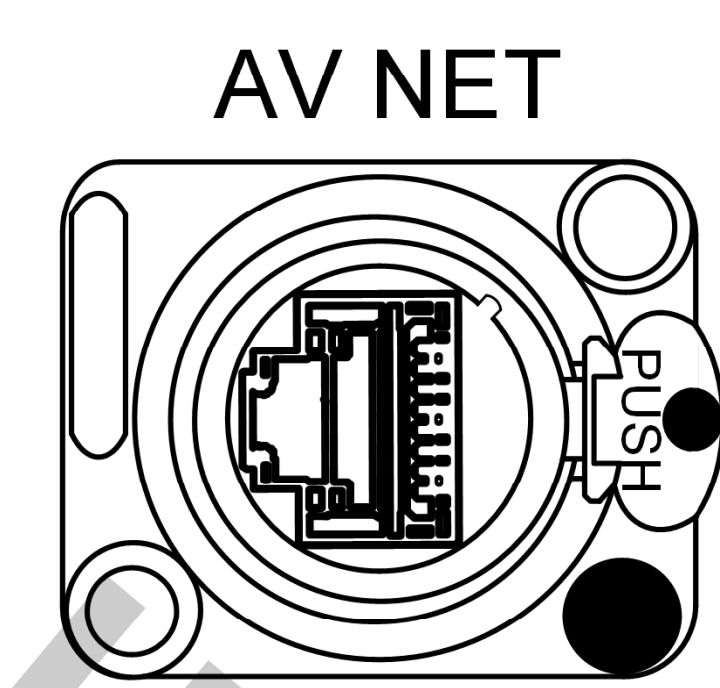
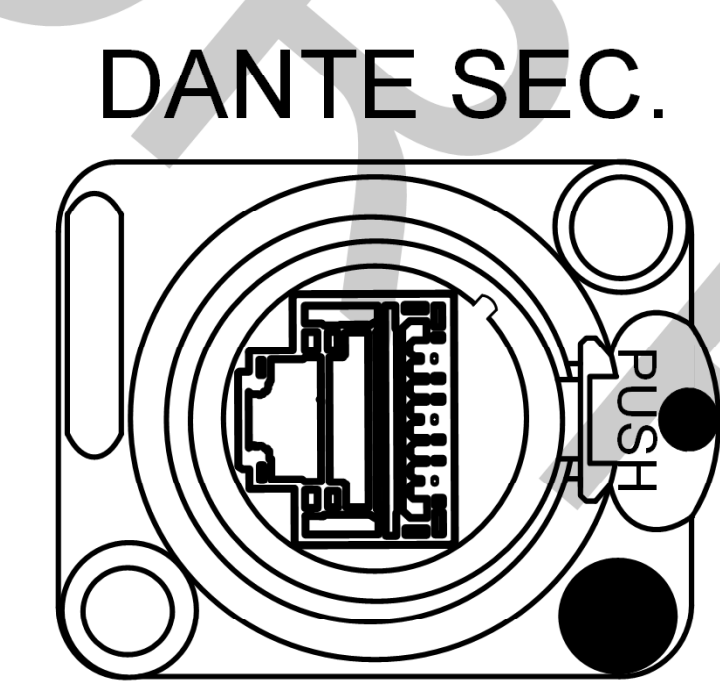
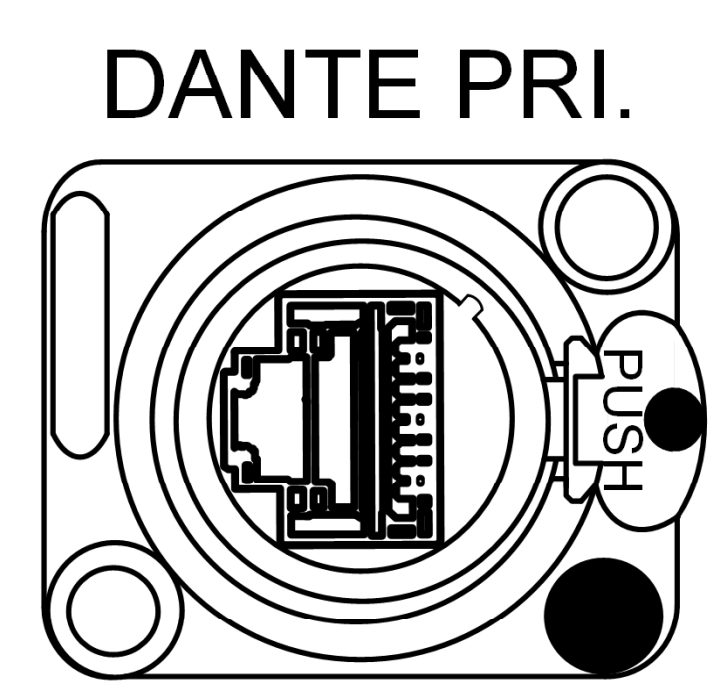
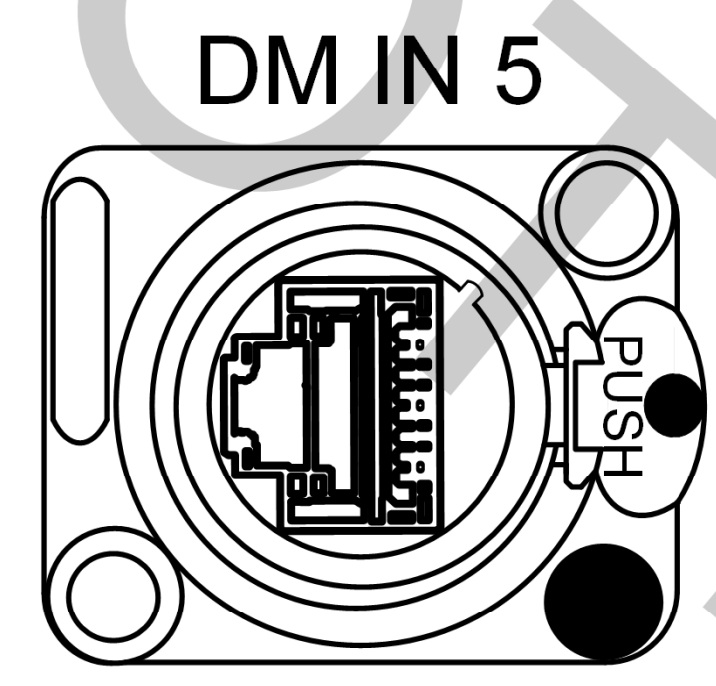
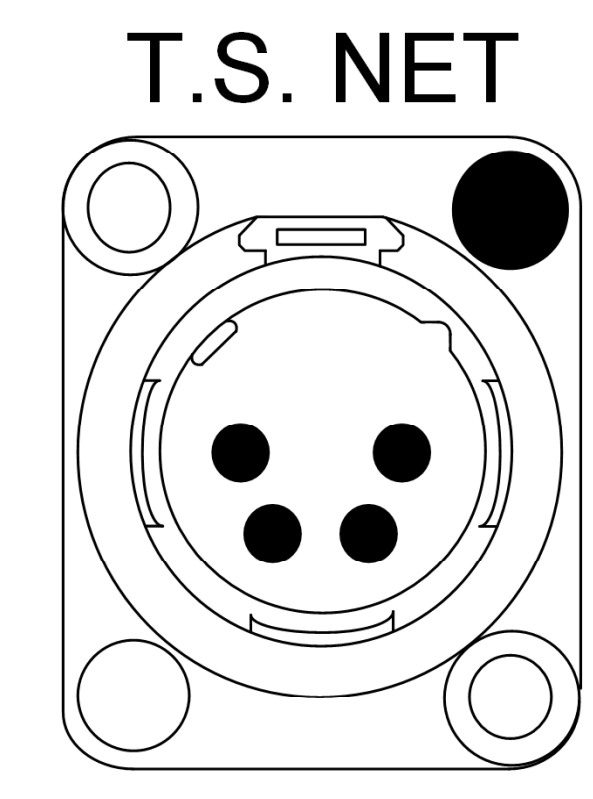
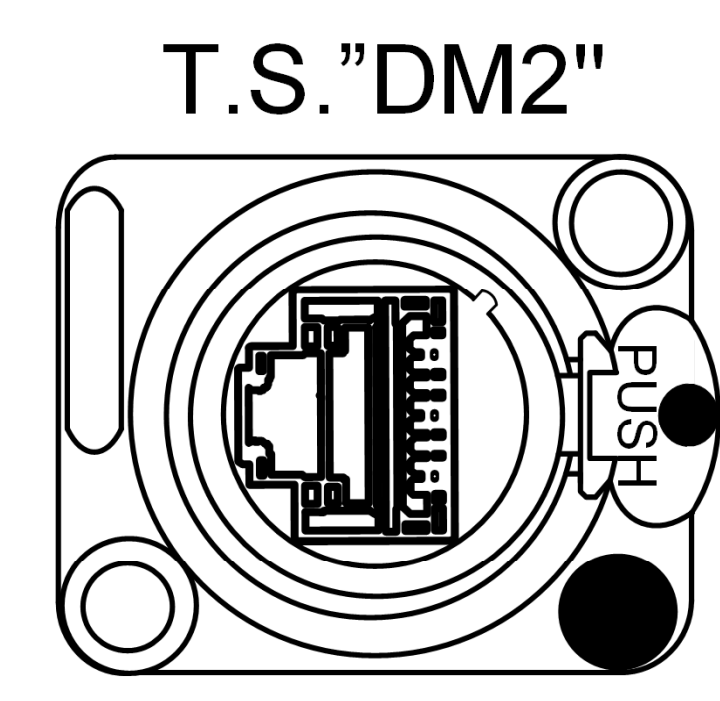
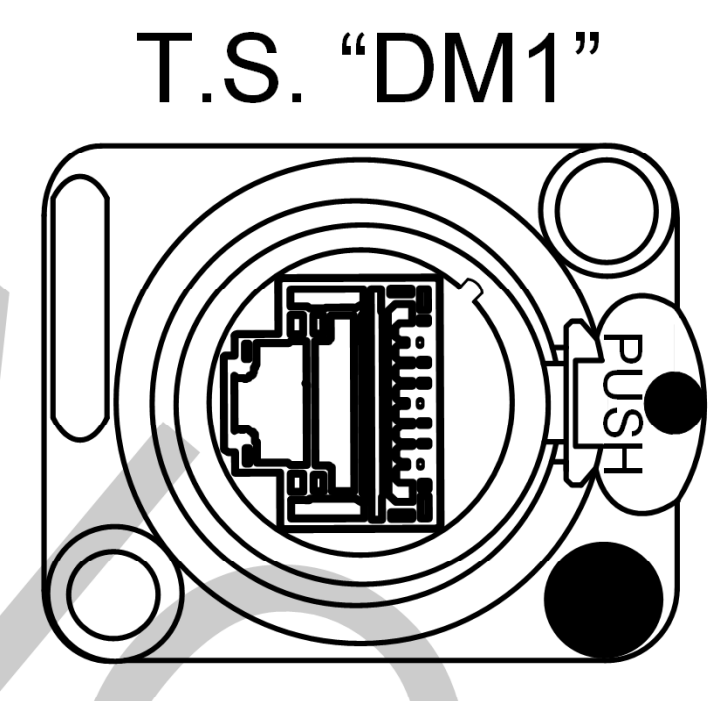

FOR REFERENCE
PURPOSES ONLY

FOR REFERENCE
PURPOSES ONLY

CONTROL BOOTH "CMBP"

NOT TO SCALE

FOR REFERENCE
PURPOSES ONLY

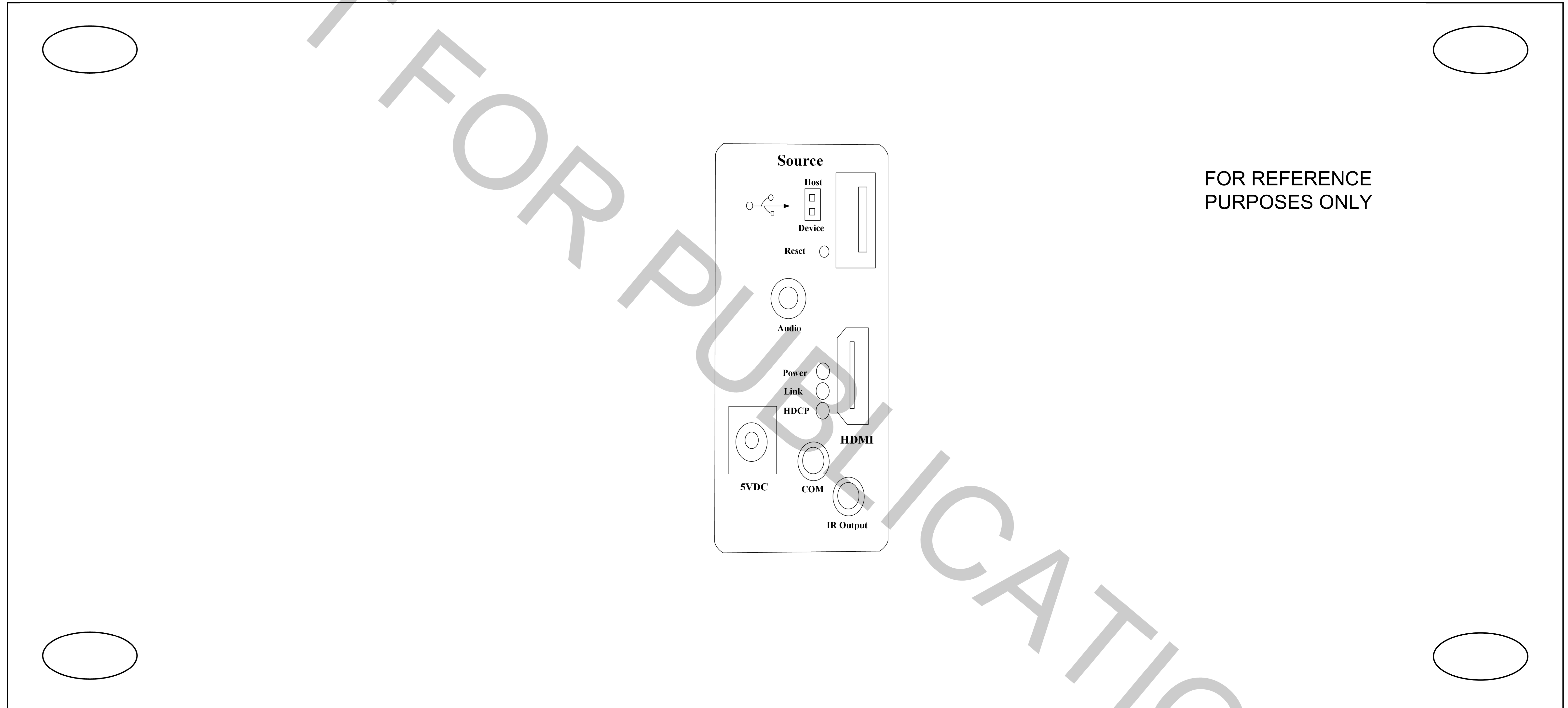

FOR REFERENCE
PURPOSES ONLY

PAN 1

NOT TO SCALE

FOR REFERENCE
PURPOSES ONLY

FOR REFERENCE
PURPOSES ONLY

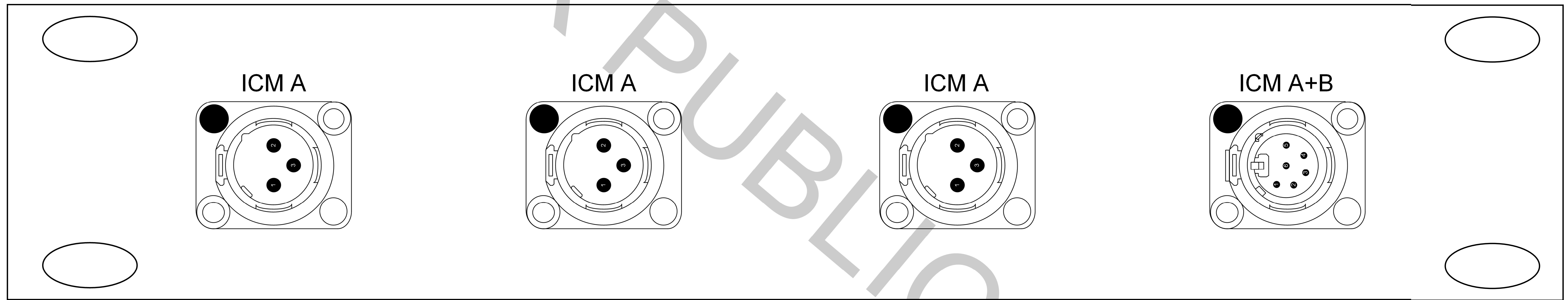

FOR REFERENCE
PURPOSES ONLY

PAN 2
NOT TO SCALE

FOR REFERENCE
PURPOSES ONLY

FOR REFERENCE
PURPOSES ONLY

FOR REFERENCE
PURPOSES ONLY

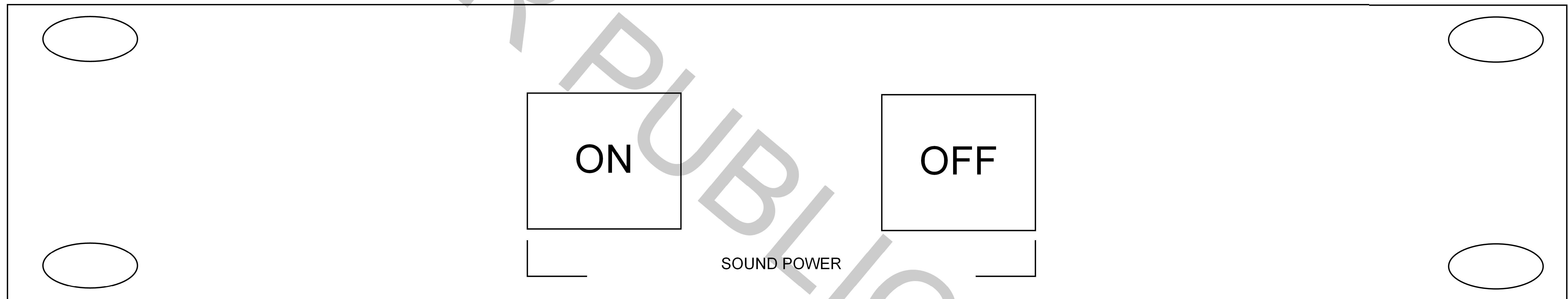

PAN 3
NOT TO SCALE

FOR REFERENCE
PURPOSES ONLY

FOR REFERENCE
PURPOSES ONLY

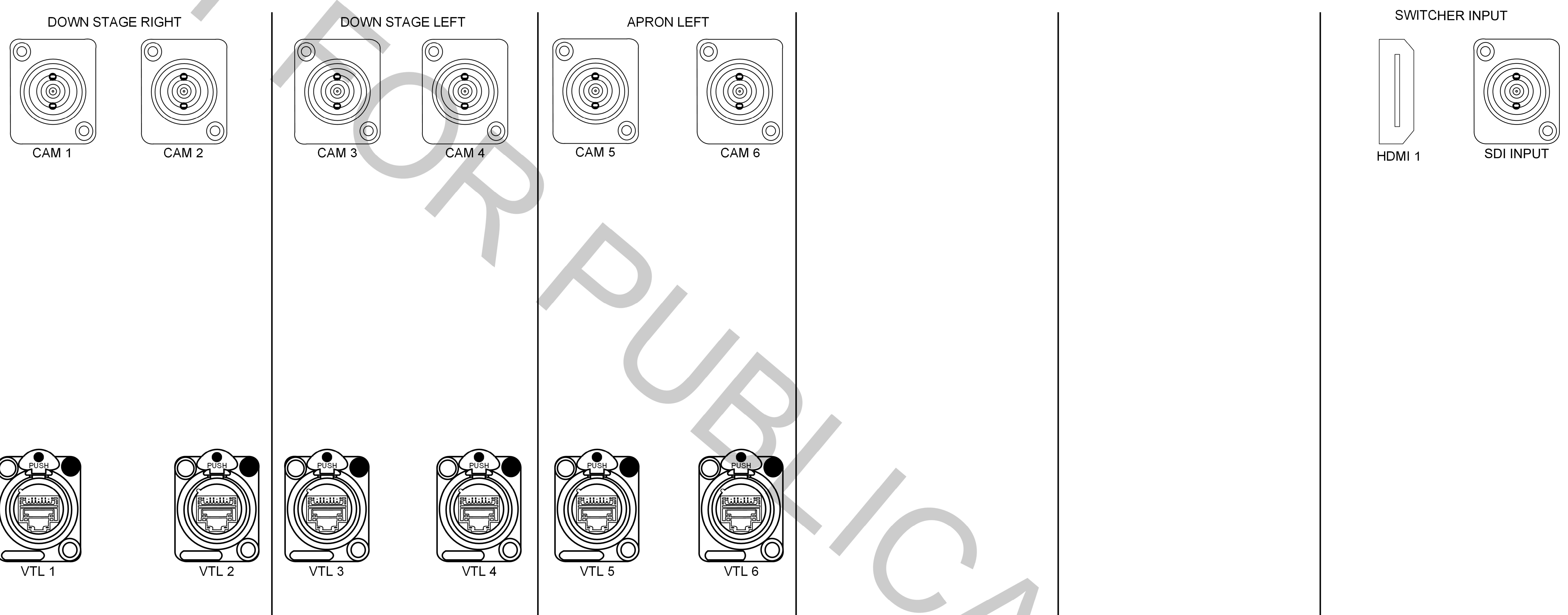

FOR REFERENCE
PURPOSES ONLY

PAN 4

NOT TO SCALE

FOR REFERENCE
PURPOSES ONLY

FOR REFERENCE
PURPOSES ONLY

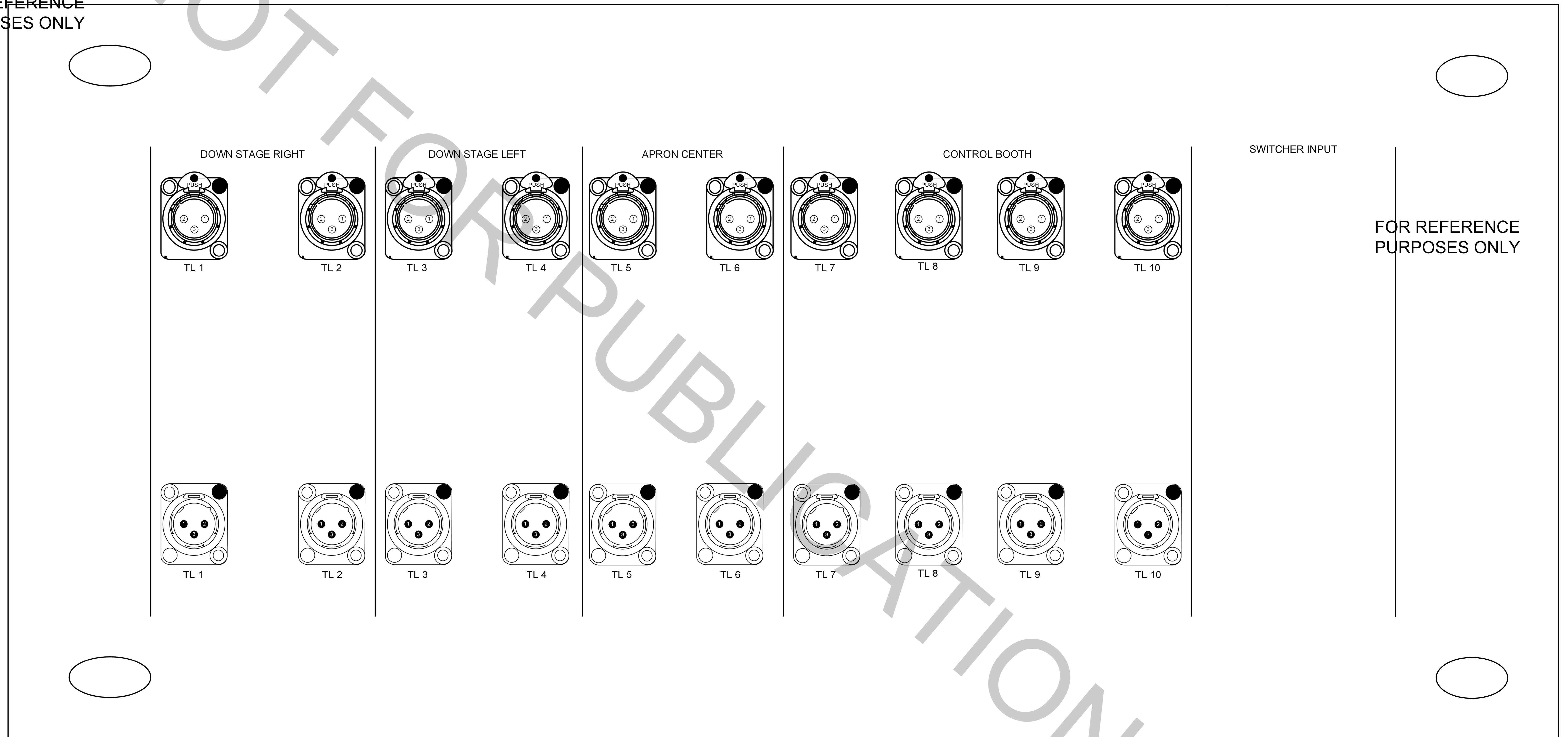

FOR REFERENCE
PURPOSES ONLY

PAN 5

NOT TO SCALE

FOR REFERENCE
PURPOSES ONLY

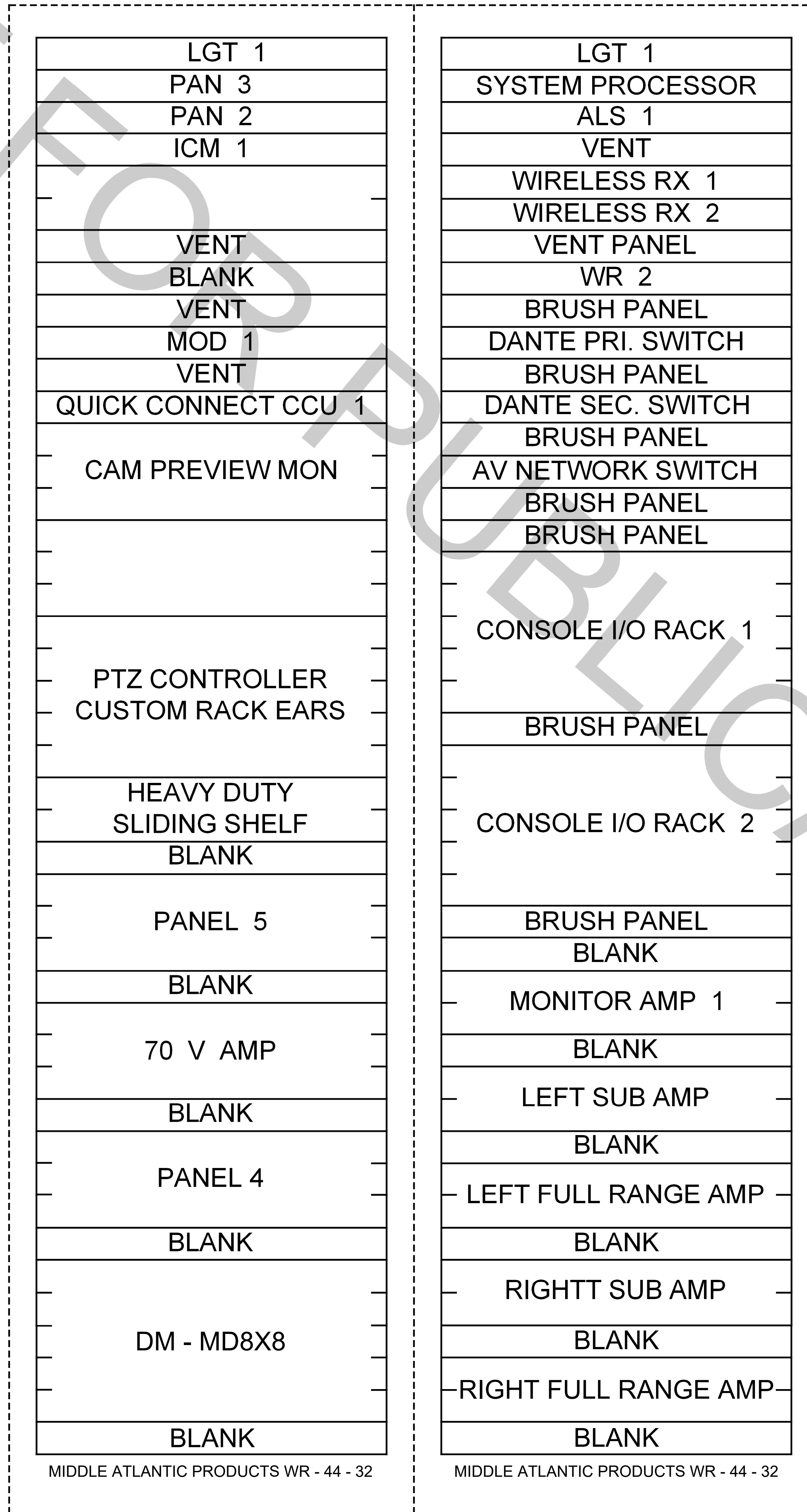

SOUND RACK 2 (RS2)

SOUND RACK 1 (RS1)

FOR REFERENCE
PURPOSES ONLY

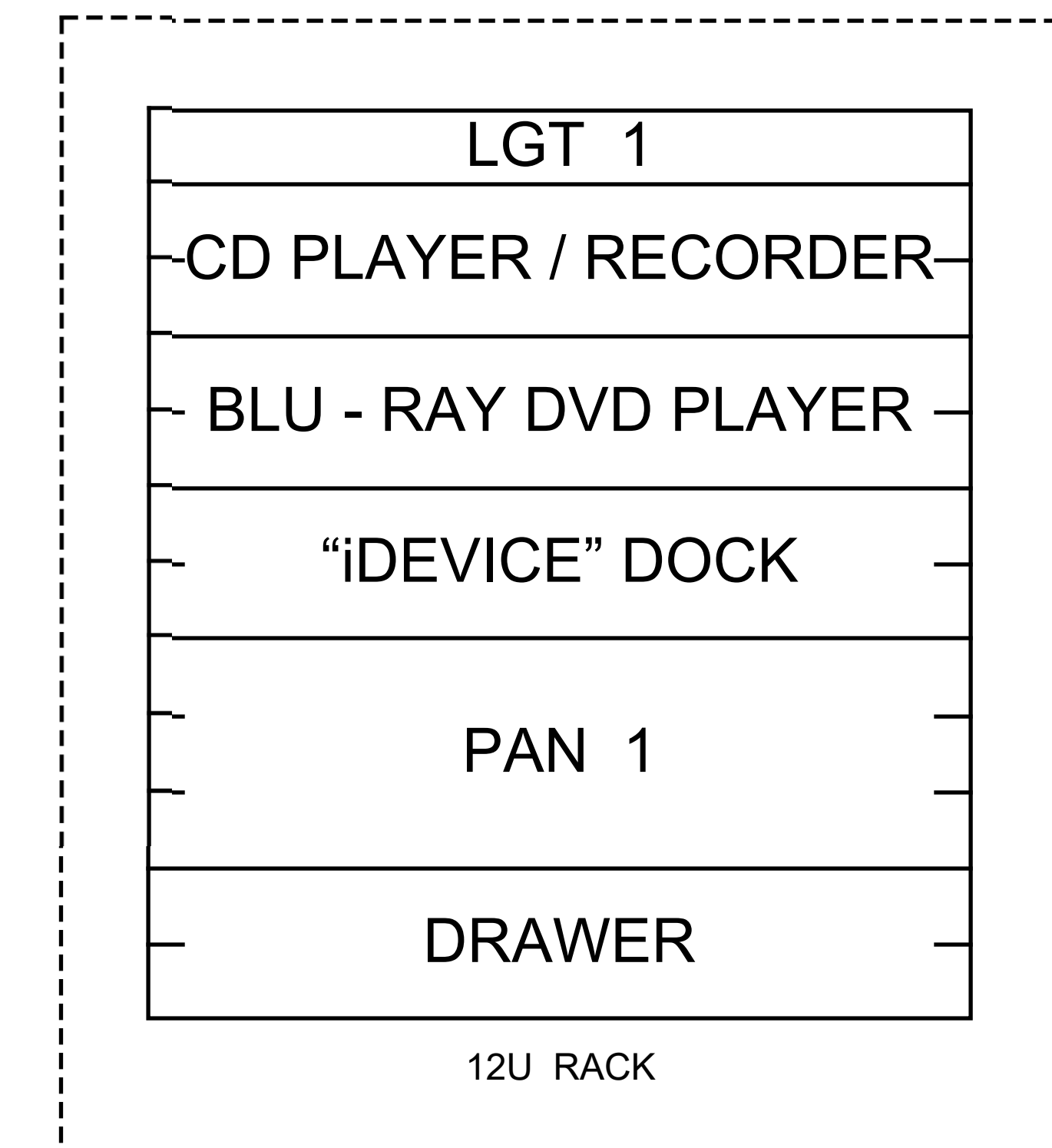

FOR REFERENCE
PURPOSES ONLY

FD (IDF) KEYNOTES X

1. WALL FIELD FOR SERVICES INDICATED – BEGINNING SIX (6) INCHES A.F.F. PROVIDE AND INSTALL READYSPEC 4' BY 4' SECTIONS OF VOICE AND DATA BACKBOARD 8" HIGH. PROVIDED WITH MANUFACTURER PAINTED TWO (2) COATS OF WHITE FIRE RETARDANT PAINT. PAINT TWO (2) INCH STENCIL LETTERS ON BOTH SIDES TOP AND BOTTOM. LETTERS FOR EACH APPLICABLE SYSTEM TO BE INSTALLED SHALL BE IN DISTINCT COLORS AS LISTED BELOW:

VOICE / DATA:
INTERCOM:
SECURITY:
FIRE ALARM:
HVAC / AUX:

YELLOW
GREEN
ORANGE
RED
BLACK

2. RE-ENTERABLE AND RE-USEABLE FIREWALL PENETRATION ASSEMBLIES, QUANTIFY AND LOCATIONS PROJECT SPECIFIC AS INDICATED. "EZPATH" PRODUCT OR EQUIVALENT MECHANICAL FIRE PROTECTION AS APPROVED BY PROJECT ENGINEER.
3. MINIMUM THREE (3) NEMA L6 30R 208VAC TWIST LOCK POWER RECEPTACLE TO BE INSTALLED IN THE IDF AT LOCATIONS INDICATED. ALL POWER RECEPTACLES INSTALLED VERTICAL AT 80" A.F.F. ALL LOCATIONS – TYPICAL. SURFACE MOUNTED APPLICATION NOT ACCEPTABLE IN NEW CONSTRUCTION U.O.N. MINIMUM ONE (1) NEMA 5 20R 120VAC DUPLEX POWER RECEPTACLE INSTALLED EVERY EIGHT FEET HORIZONTAL 360 DEGREES AROUND PERIMETER OF SPACE. ALL POWER RECEPTACLES INSTALLED VERTICAL AT 80" A.F.F. ALL LOCATIONS – TYPICAL. SURFACE MOUNTED APPLICATION NOT ACCEPTABLE IN NEW CONSTRUCTION U.O.N.
4. DATA OUTLETS SHALL BE INSTALLED PROJECT SPECIFIC AS INDICATED TYPICAL AT 80" A.F.F. WITHIN 12" HORIZONTAL OF DUPLEX POWER RECEPTACLE.
5. TELECOMMUNICATIONS GROUNDING BUS BAR "TGBB" SYSTEMS GROUND BAR – REFER TO SYSTEMS GROUNDING RISER AS DETERMINED BY PROJECT ENGINEER.
6. 12" WIDE LADDER RACK INSTALLED CONTINUOUSLY AS SHOWN – TYPICAL. LAYOUT REQUIREMENTS SHALL BE PROJECT SPECIFIC.
7. AIR CONDITIONER SPLIT UNIT INSTALLED OVER THE DOOR AS SHOWN. ALL HVAC PIPES AND DRAINS SHALL IMMEDIATELY TURN AND BE PIPED BY HVAC TRADES TO THE OUTSIDE OF THE FD (IDF) SPACE.
8. MINIMUM THREE (3) FOUR INCH TELECOMMUNICATIONS BACKBONE CONDUITS WITH THREE (3) THREE CELL FABRIC INNERDUCTS (FOR MULTIPLE STORY FLOORS MINIMUM TWO (2) FOUR INCH TELECOMMUNICATIONS SLEEVES) PER FD (IDF) SPACE.
9. FINAL RACK PLACEMENT SHALL BE CONFIRMED BY PROJECT ENGINEER AND SDOC TECHNOLOGY SERVICES DEPARTMENT REPRESENTATIVE PRIOR TO ANCHORING.
10. ALL FD (IDF) SPACES SHALL BE MINIMUM TEN (10) FEET LONG BY TEN (10) FEET WIDE.
11. ALL IDF ENTRY DOOR OPENINGS SHALL BE MINIMUM FOUR (4) FEET WIDE.
12. ALL UNDERGROUND BACKBONE CONDUIT SHALL CONTAIN DETECTABLE MAXCELL THREE (3) THREE CELL FABRIC INTERDUCT.

FOR REFERENCE
PURPOSES ONLY

FOR REFERENCE
PURPOSES ONLY

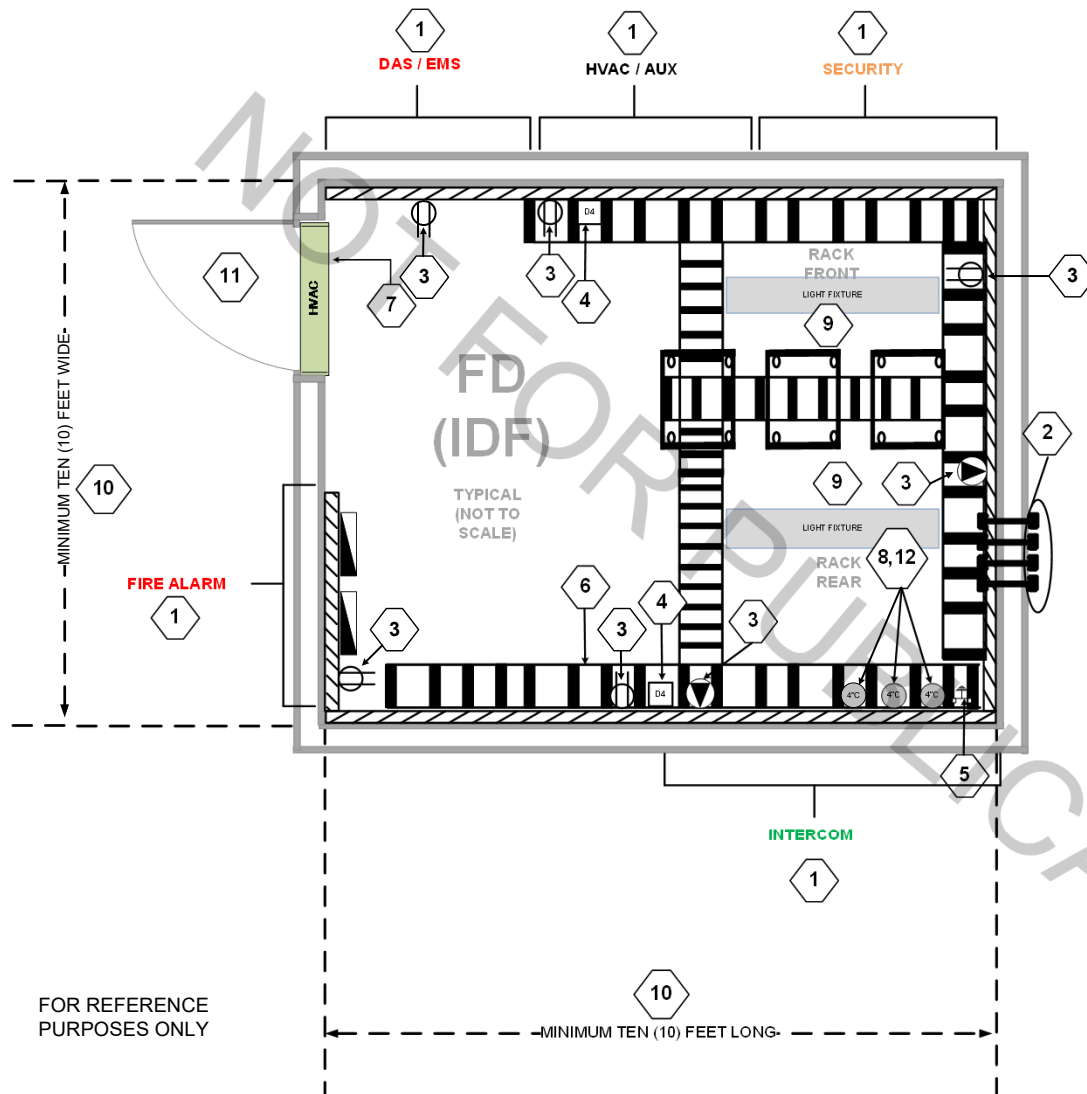

TYPICAL FD (IDF) SPACE
CONFIGURATION

FOR REFERENCE
PURPOSES ONLY

CD (MDF) KEYNOTE

FOR REFERENCE
PURPOSES ONLY

FOR REFERENCE
PURPOSES ONLY

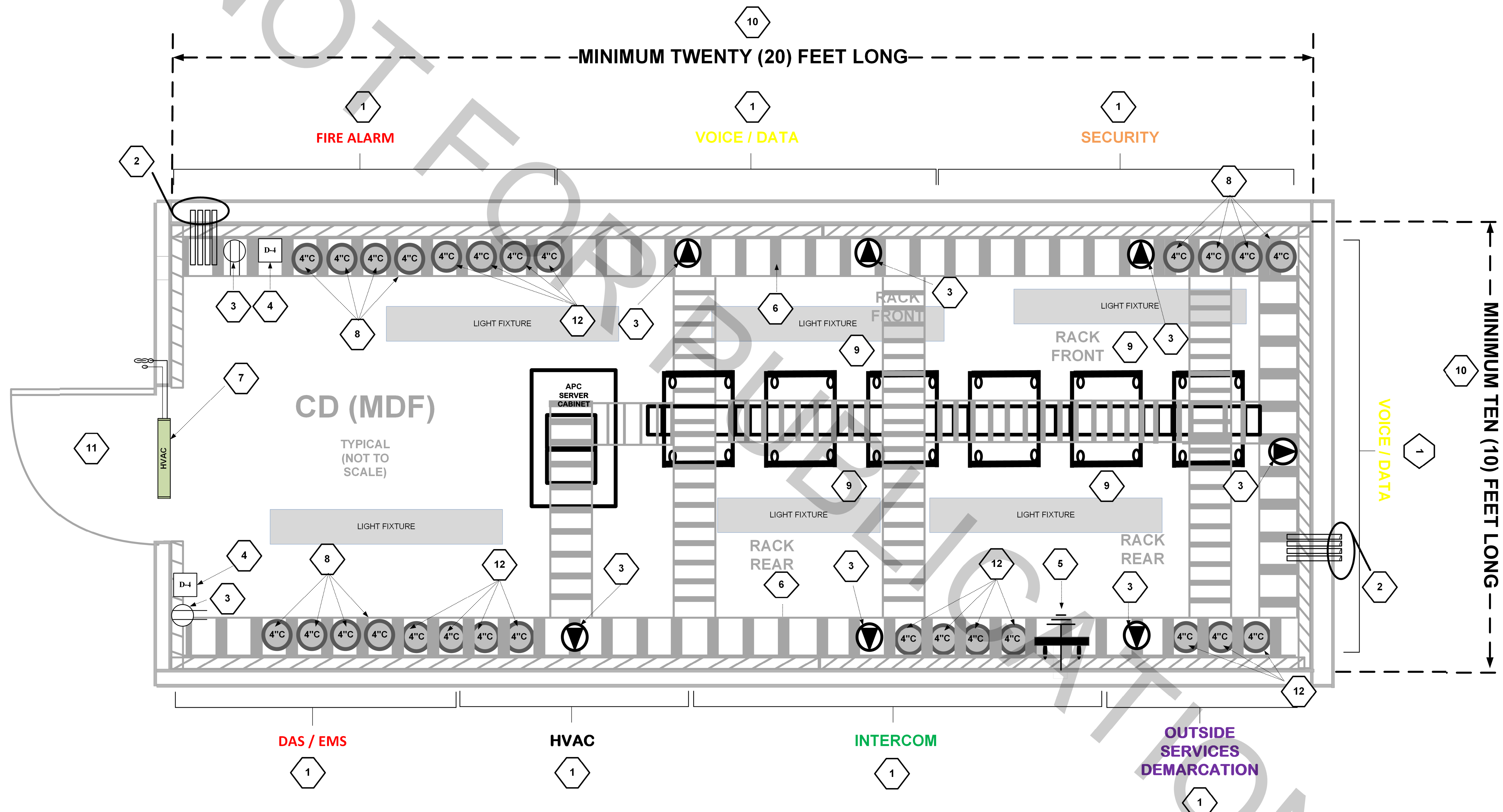

FOR REFERENCE
PURPOSES ONLY

TYPICAL CD (MDF) SPACE CONFIGURATION

- WALL FIELD FOR SERVICES INDICATED – BEGINNING SIX (6) INCHES A.F.F. PROVIDE AND INSTALL READYSPEC 4' BY 4' SECTIONS OF VOICE AND DATA BACKBOARD 8' HIGH, PROVIDED WITH MANUFACTURER PAINTED TWO (2) COATS OF WHITE FIRE RETARDANT PAINT. PAINT TWO (2) INCH STENCIL LETTERS ON BOTH SIDES TOP AND BOTTOM. LETTERS FOR EACH APPLICABLE SYSTEM TO BE INSTALLED SHALL BE IN DISTINCT COLORS AS LISTED BELOW:

VOICE / DATA:	YELLOW
INTERCOM:	GREEN
SECURITY:	ORANGE
FIRE ALARM:	RED
HVAC:	BLACK
OUTSIDE SERVICES:	PURPLE
- RE-ENTERABLE AND RE-USEABLE FIREWALL PENETRATION ASSEMBLIES, QUANTIFY AND LOCATIONS PROJECT SPECIFIC AS INDICATED. "EZPATH" PRODUCT OR EQUIVALENT AS APPROVED BY PROJECT ENGINEER.
- MINIMUM SIX (6) NEMA 208VAC L6 30R TWISTLOCK POWER RECEPTACLE TO BE INSTALLED IN THE IDF AT LOCATIONS INDICATED. ALL POWER RECEPTACLES INSTALLED VERTICAL AT 80" A.F.F. ALL LOCATIONS – TYPICAL. SURFACE MOUNTED APPLICATION NOT ACCEPTABLE IN NEW CONSTRUCTION U.O.N. MINIMUM ONE (1) 120VAC 15A DUPLEX POER RECEPTACLE INSTALLED EVERY EIGHT FEET HORIZONTAL 360 DEGREES AROUND PERIMETER OF SPACE. ALL POWER RECEPTACLES INSTALLED VERTICAL AT 80" A.F.F. ALL LOCATIONS – TYPICAL. SURFACE MOUNTED APPLICATION NOT ACCEPTABLE IN NEW CONSTRUCTION U.O.N.
- DATA OUTLETS SHALL BE INSTALLED PROJECT SPECIFIC AS INDICATED TYPICAL AT 80" A.F.F. WITHIN 12" HORIZONTAL OF DUPLEX POWER RECEPTACLE.
- TELECOMMUNICATIONS GROUNDING BUS BAR "TGBB" SYSTEMS GROUND BAR – REFER TO SYSTEMS GROUNDING RISER AS DETERMINED BY PROJECT ENGINEER.
- 12" WIDE LADDER RACK INSTALLED CONTINUOUSLY AS SHOWN – TYPICAL. LAYOUT REQUIREMENTS SHALL BE PROJECT SPECIFIC.
- AIR CONDITIONER SPLIT UNIT INSTALLED OVER THE DOOR AS SHOWN. ALL HVAC PIPES AND DRAINS SHALL IMMEDIATELY TURN AND BE PIPED BY HVAC TRADES TO THE OUTSIDE OF THE IDF SPACE.
- MINIMUM THREE (3) FOUR INCH TELECOMMUNICATION BACKBONE CONDUITS WITH THREE FABRIC INNERDUCTS (FOR MULTIPLE STORY FLOORS MINIMUM TWO (2) FOUR INCH TELECOMMUNICATIONS SLEEVES) PER IDF SPACE.
- FINAL RACK PLACEMENT SHALL BE CONFIRMED BY PROJECT ENGINEER AND SDOC TECHNOLOGY SERVICES DEPARTMENT REPRESENTATIVE PRIOR TO ANCHORING.
- ALL MDF SPACES SHALL BE MINIMUM TWENTY (20) FEET LONG BY TEN (10) FEET WIDE.
- ALL MDF ENTRY DOOR OPENINGS SHALL BE MINIMUM FOUR (4) FEET WIDE.
- ALL UNDERGROUND BACKBONE / SERVICE PROVIDER CONDUIT SHALL CONTAIN DETECTABLE MAXCELL THREE (3) THREE CELL FABRIC INTERDUCT.

FOR REFERENCE PURPOSES ONLY

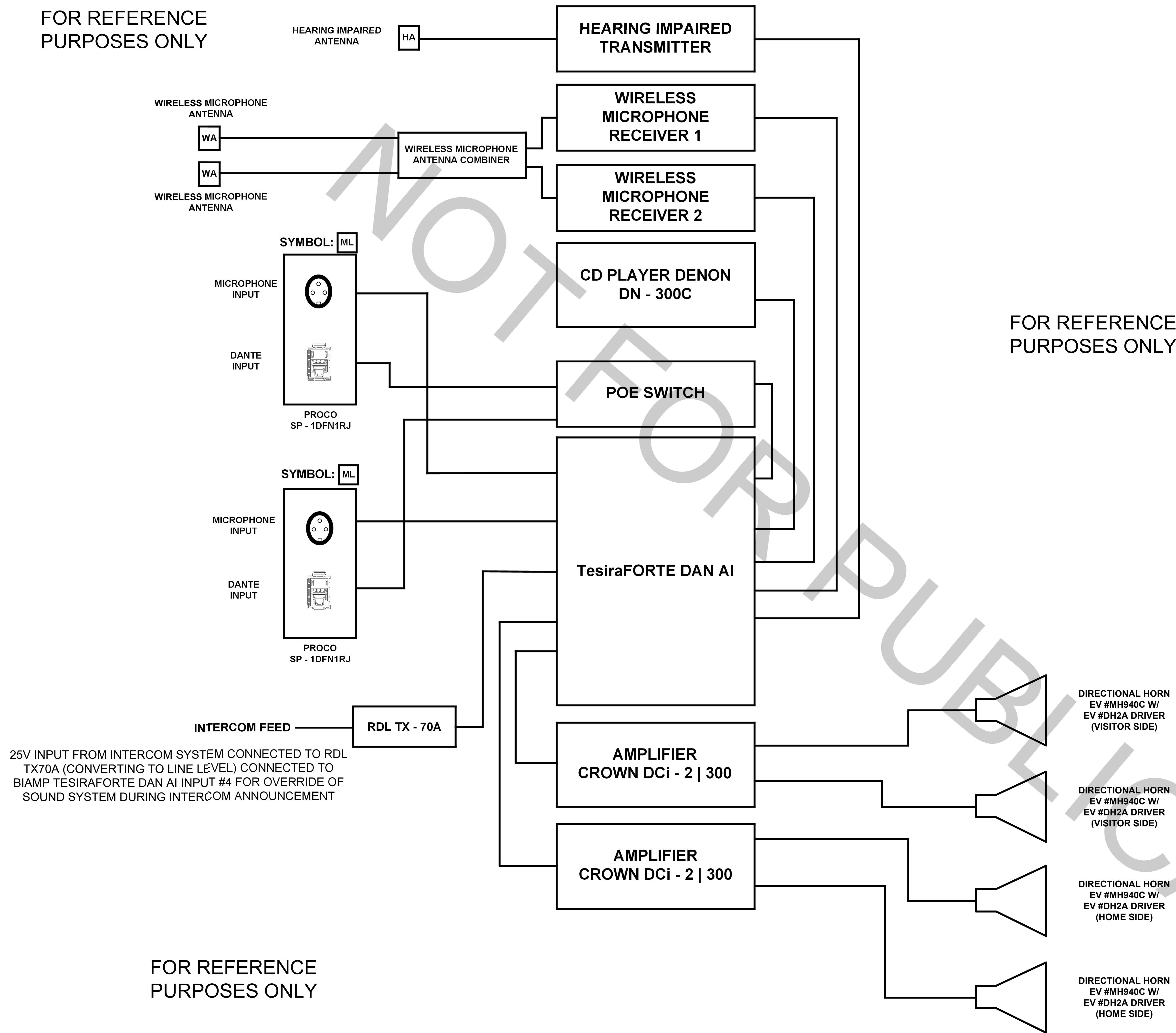

WALL MOUNT LOWELL LWR - 2123 WITH VENTED FRONT DOOR AND KEY LOCK

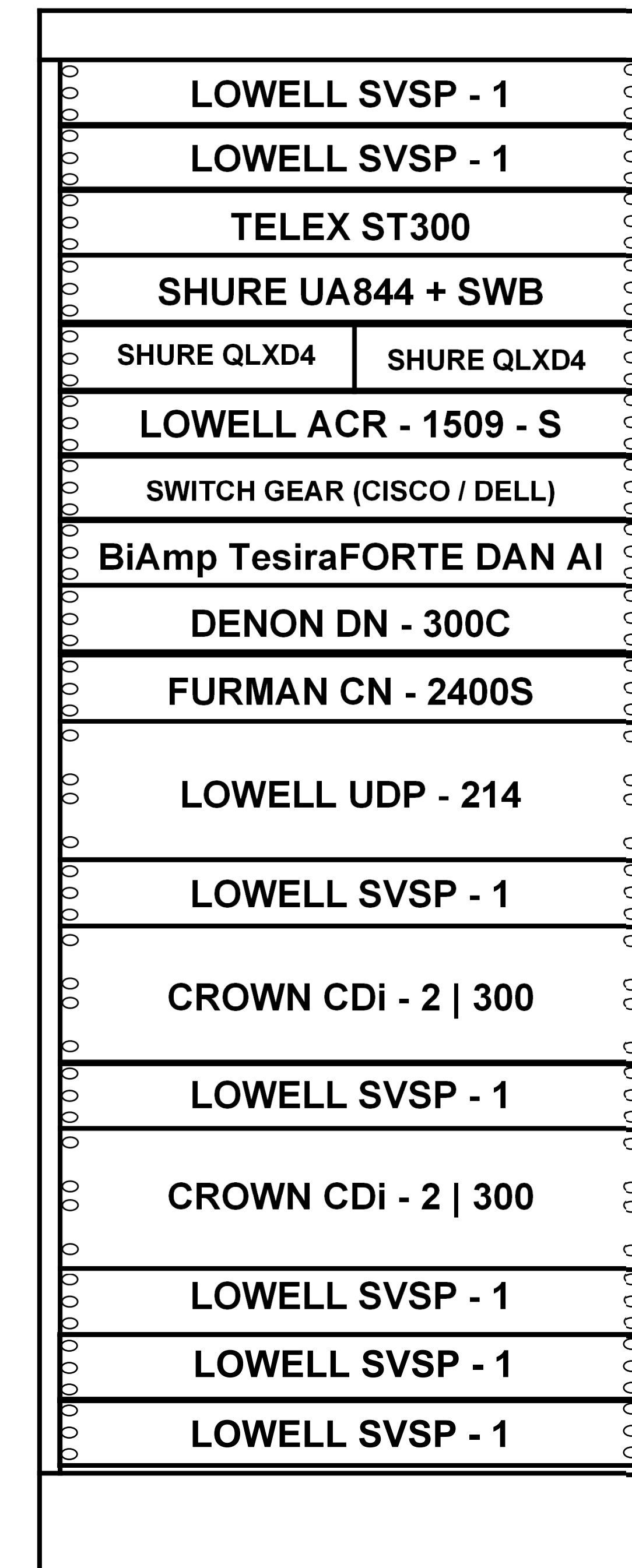

FOR REFERENCE PURPOSES ONLY

ADDITIONAL COMPONENTS:

- (2) SHURE QLXD1 WIRELESS BODY PACK TRANSMITTERS
- (2) SHURE QLXD2 / SM58 HANDHELD WIRELESS MICROPHONE TRANSMITTERS
- (2) SHURE WL185 LAVALIER CONDENSER MICROPHONES
- (2) SHURE SM58S CARDIOID MICROPHONES
- (2) 25' XLR / UNBALANCED MICROPHONE CABLES
- (2) 50' XLR MICROPHONE CABLES
- (2) MICROPHONE DESK STANDS
- (2) AUDINATE ADP-DAI-AU-2X0, DANTE AVIO INPUT ADAPTERS
- (2) RDL SF-BNC2, BI-DIRECTIONAL UNBALANCED STEREO AUDIO NETWORK INTERFACE

FOR REFERENCE PURPOSES ONLY

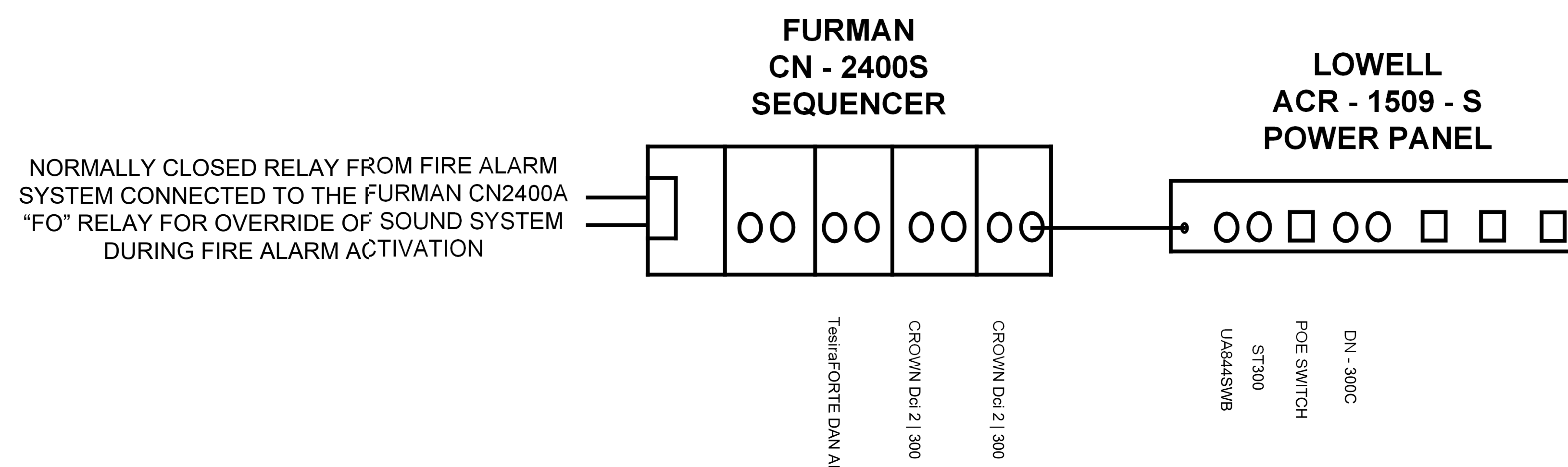

TYPICAL SPORTS STADIUM SOUND SYSTEM

NOT TO SCALE

FOR REFERENCE
PURPOSES ONLY

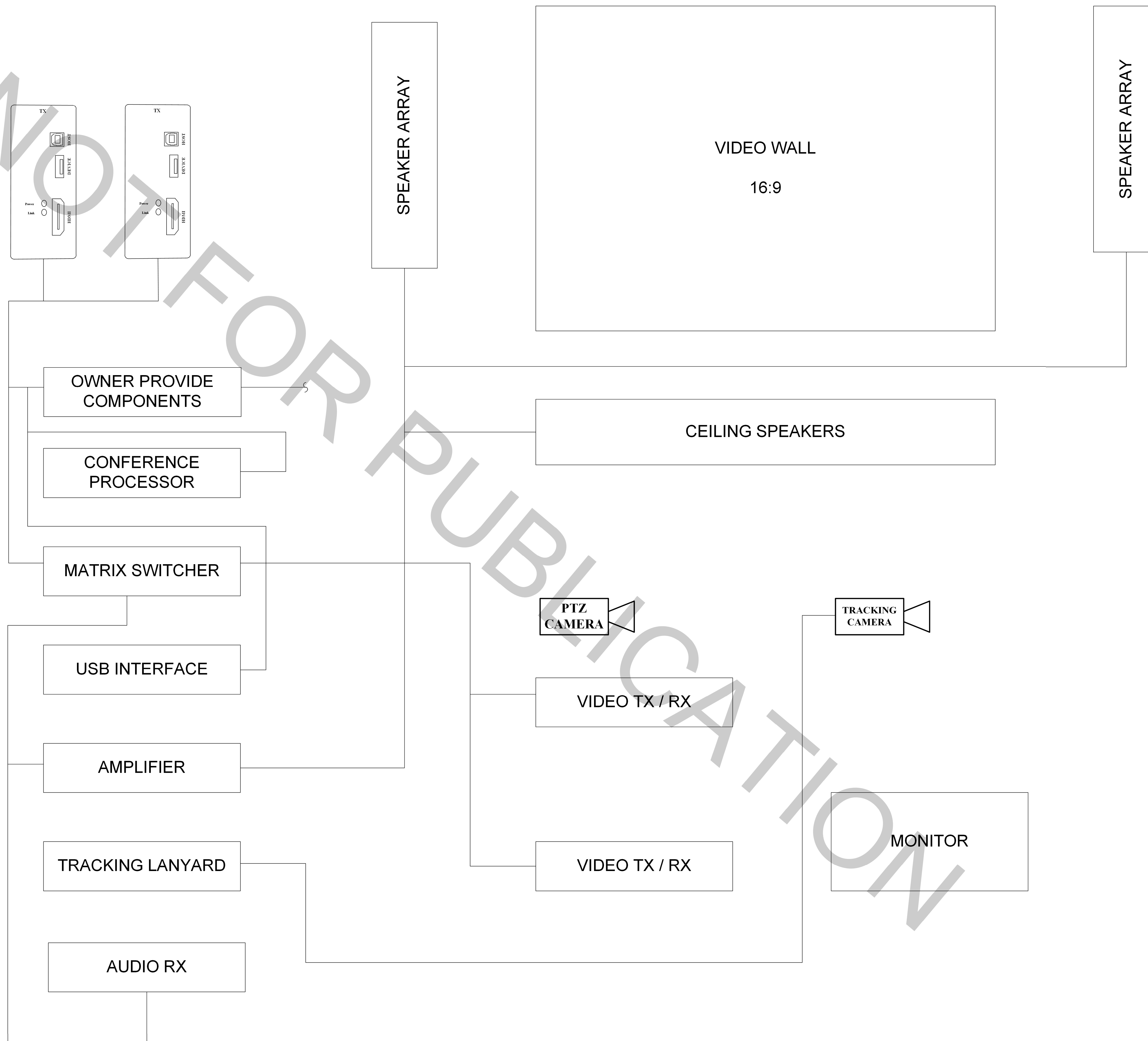

FOR REFERENCE
PURPOSES ONLY

FOR REFERENCE
PURPOSES ONLY

TYPICAL VIDEO WALL

FOR REFERENCE
PURPOSES ONLY

FOR REFERENCE
PURPOSES ONLY

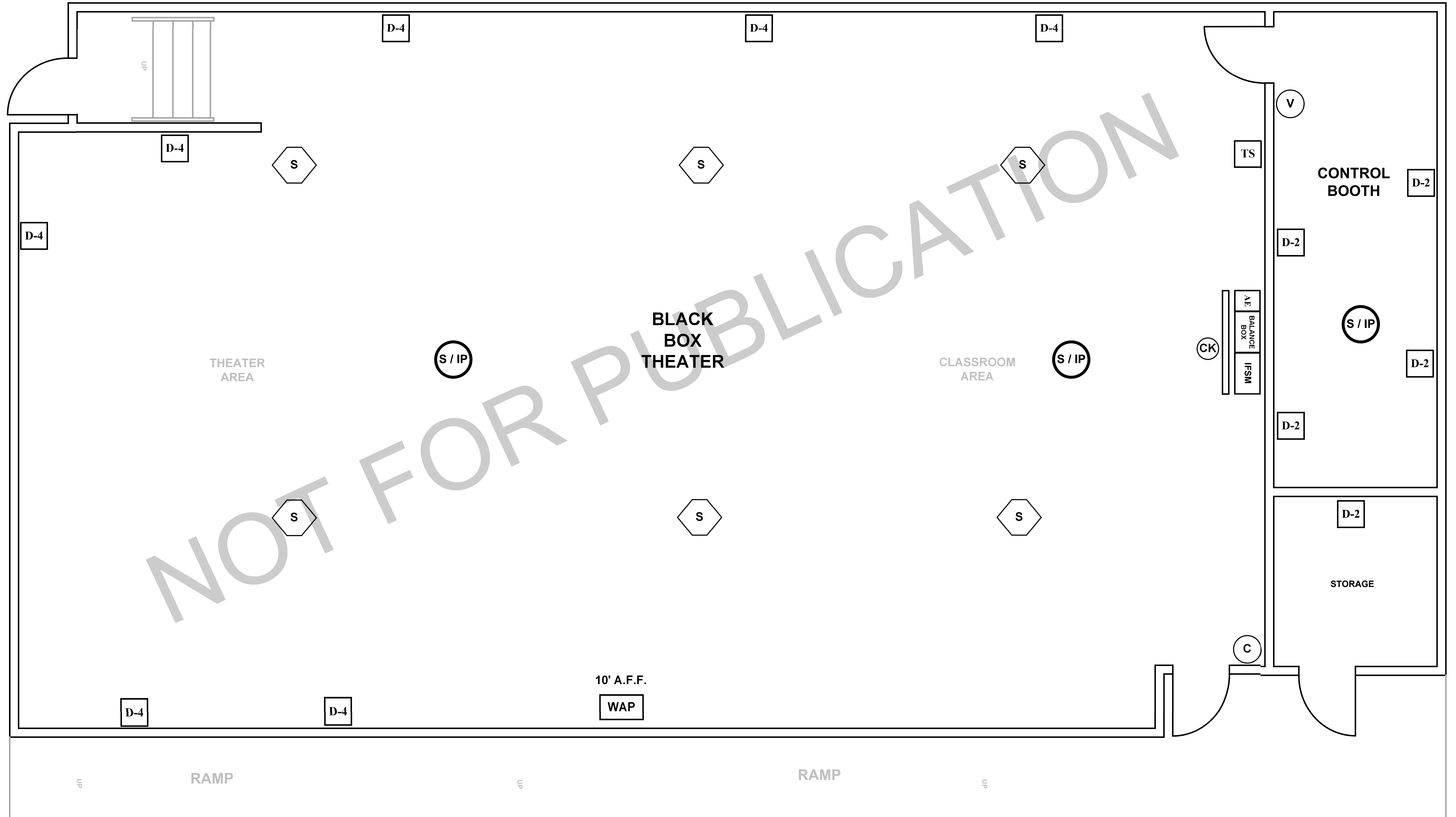

FOR REFERENCE
PURPOSES ONLY

TYPICAL BLACK BOX THEATER

FOR REFERENCE
PURPOSES ONLY

NOT TO SCALE

FOR REFERENCE
PURPOSES ONLY

FOR REFERENCE
PURPOSES ONLY

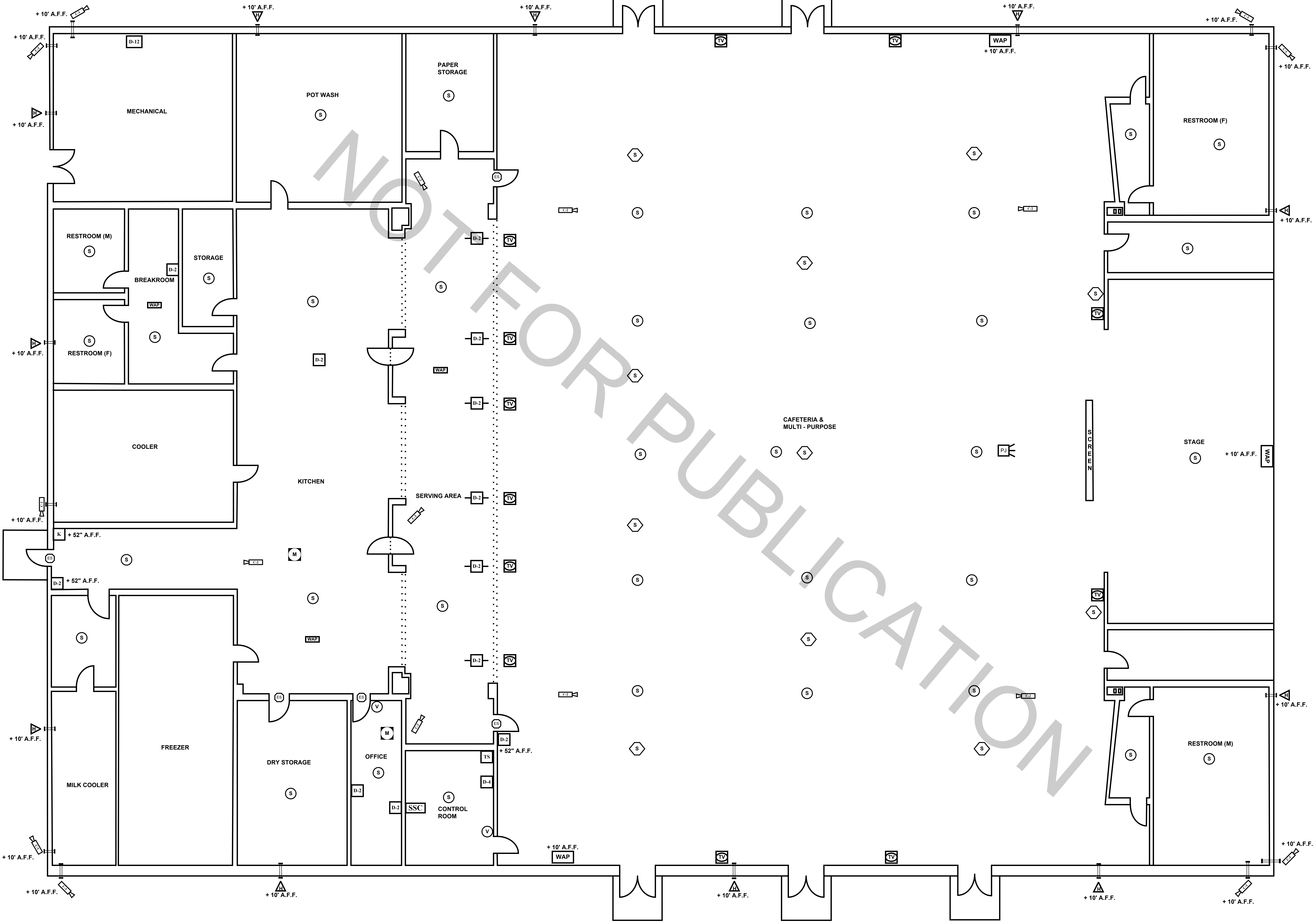

TYPICAL ELEMENTARY / MIDDLE SCHOOL CAFETORIUM

NOT TO SCALE

FOR REFERENCE
PURPOSES ONLY

FOR REFERENCE PURPOSES ONLY

FOR REFERENCE PURPOSES ONLY

26" A.F.F.

JAR

AE

C

S

S

S/IP

WAP

S

S

D2

FOR REFERENCE PURPOSES ONLY

FOR REFERENCE PURPOSES ONLY

STANDARD ELEMENTARY SCHOOL CLASSROOM "TYPICAL"

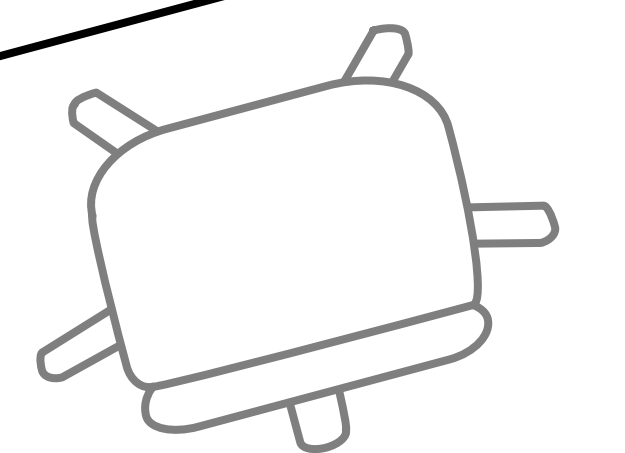

NOT FOR BIDDING

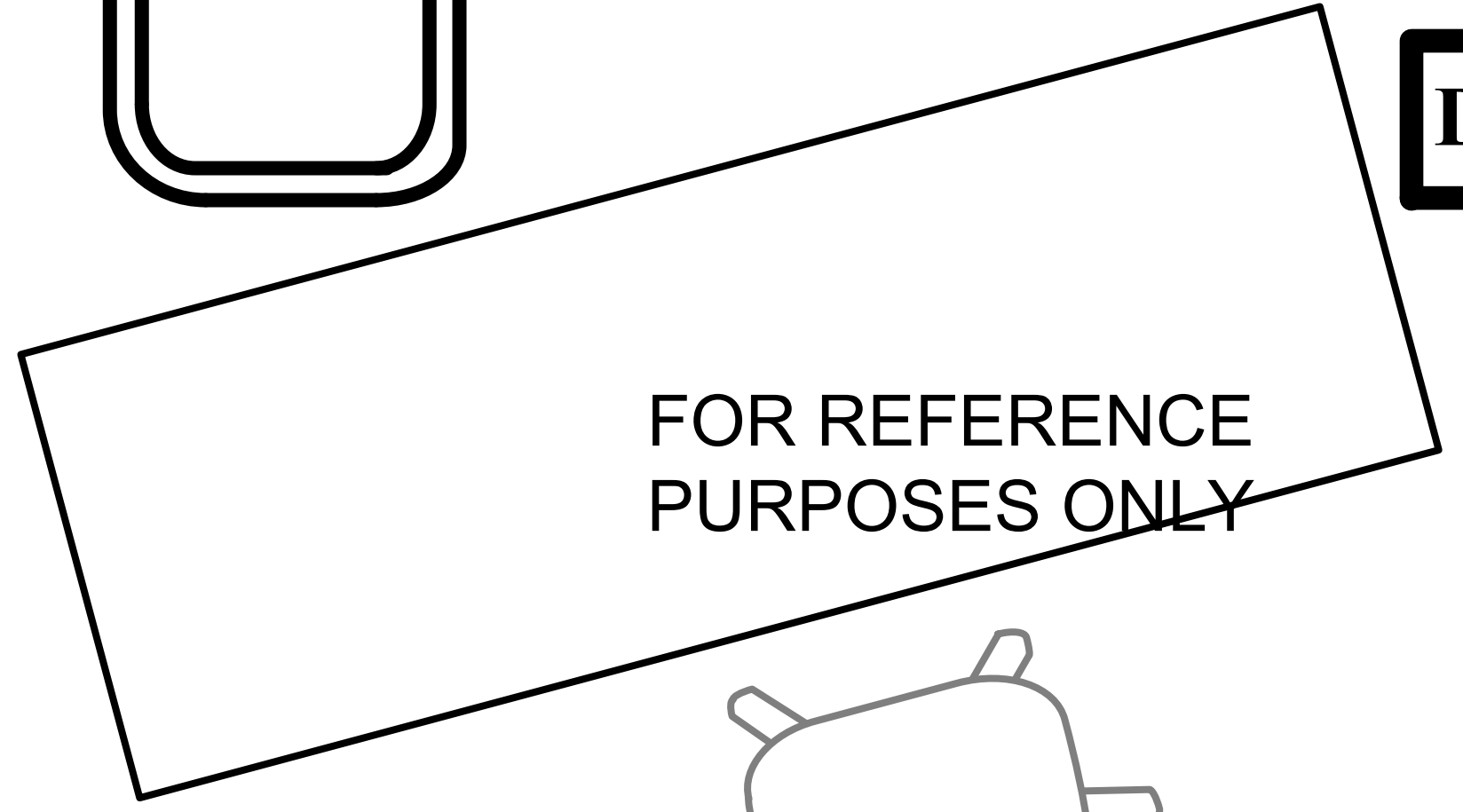
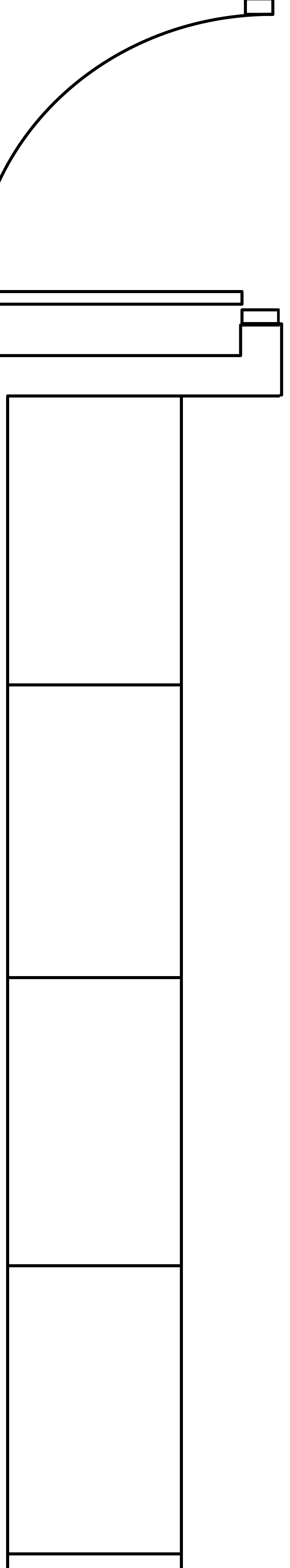
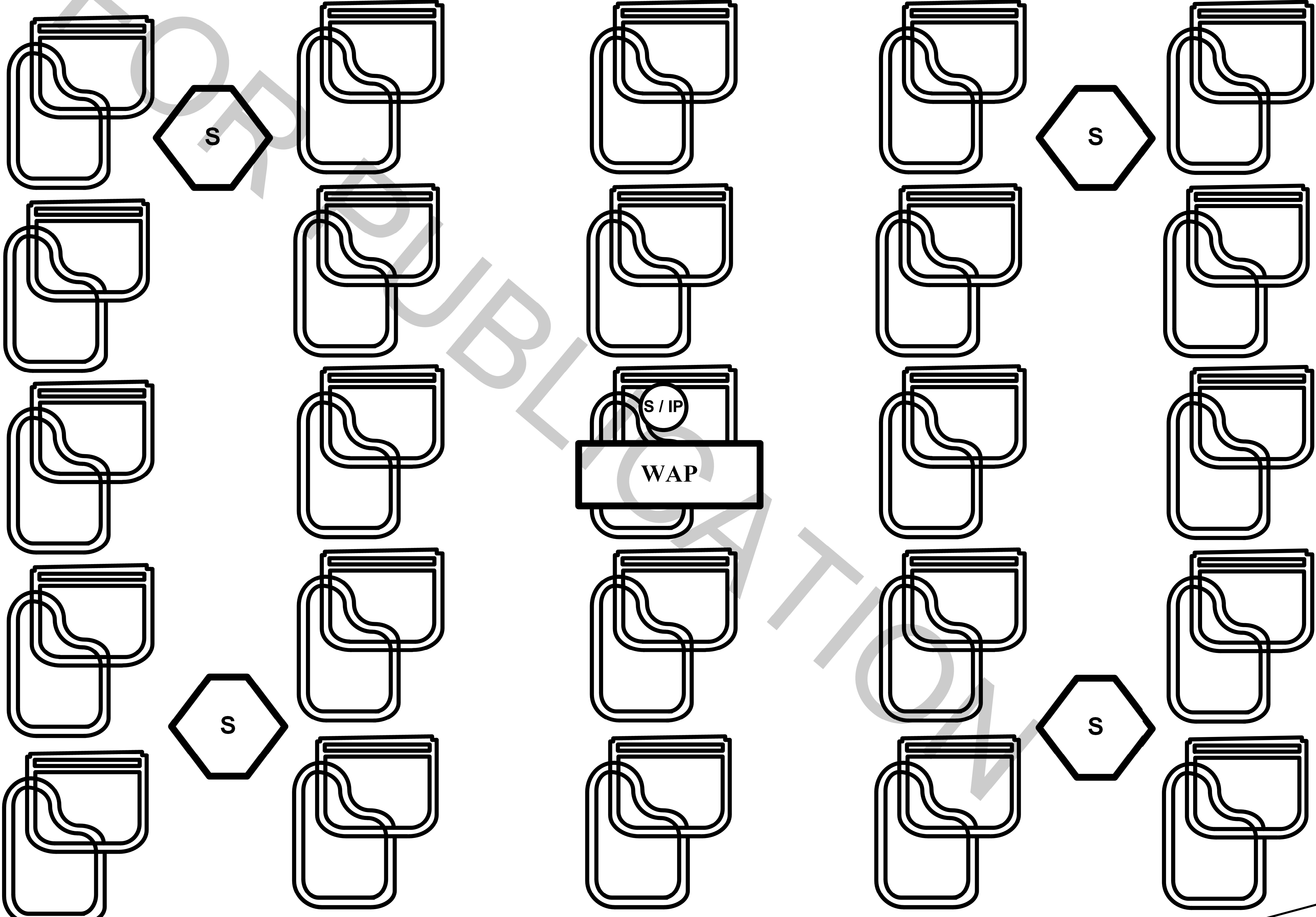
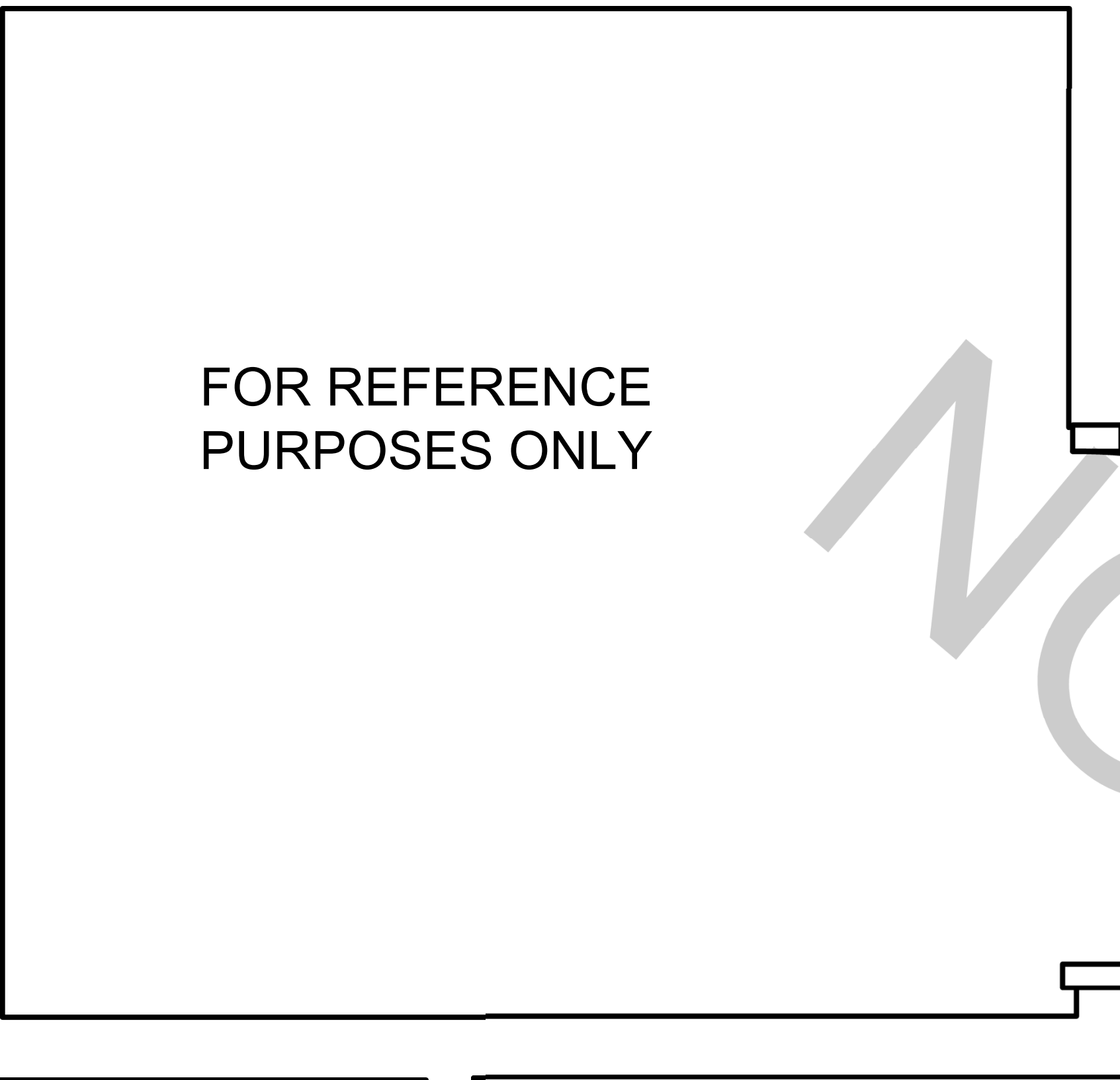
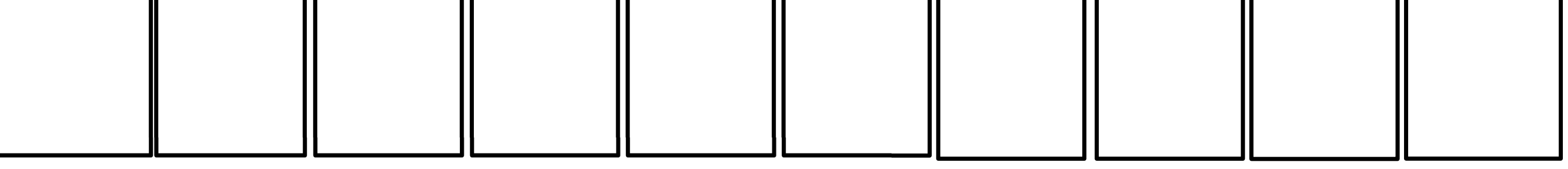
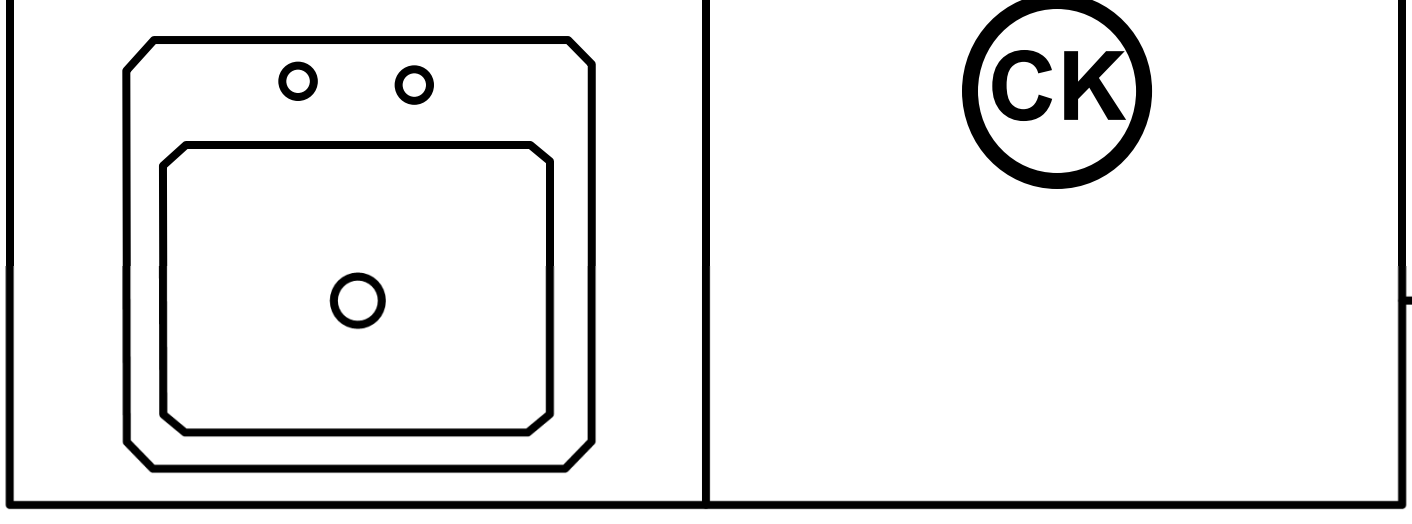

AE JAR

26" A.F.F.

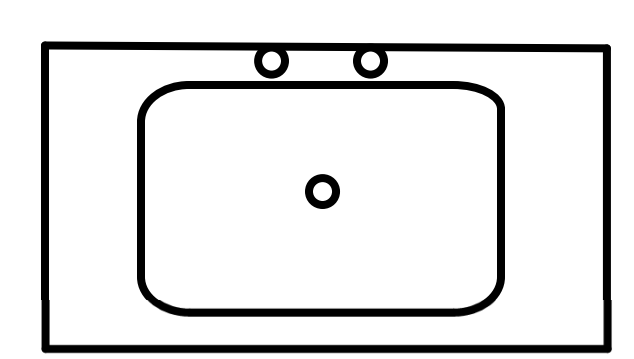
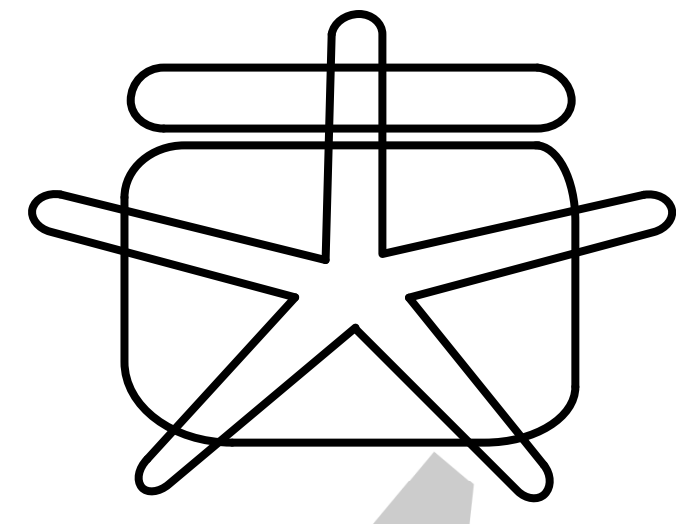

FOR REFERENCE PURPOSES ONLY

D2

STANDARD ELEMENTARY SCHOOL SKILLS LAB "TYPICAL"

FOR REFERENCE PURPOSES ONLY

NOT TO SCALE

CK

S

M

WAP

S / IP

S

D4

FOR REFERENCE PURPOSES ONLY

C

S

S

D4

FOR REFERENCE PURPOSES ONLY

D4

D4

D4

D4

D4

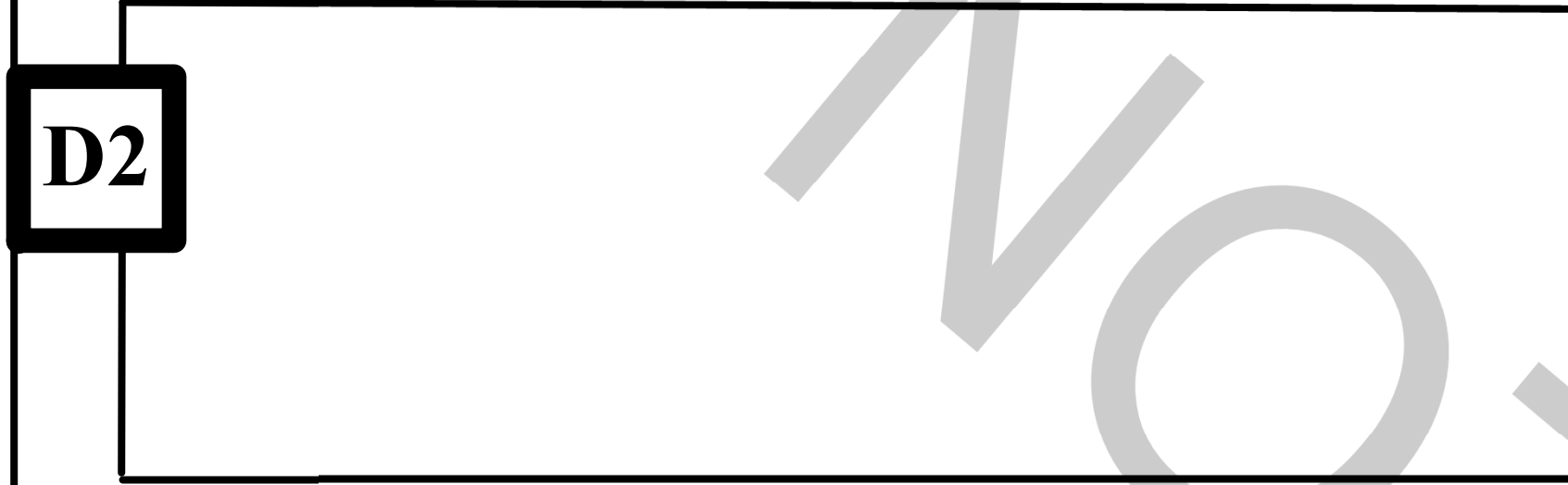
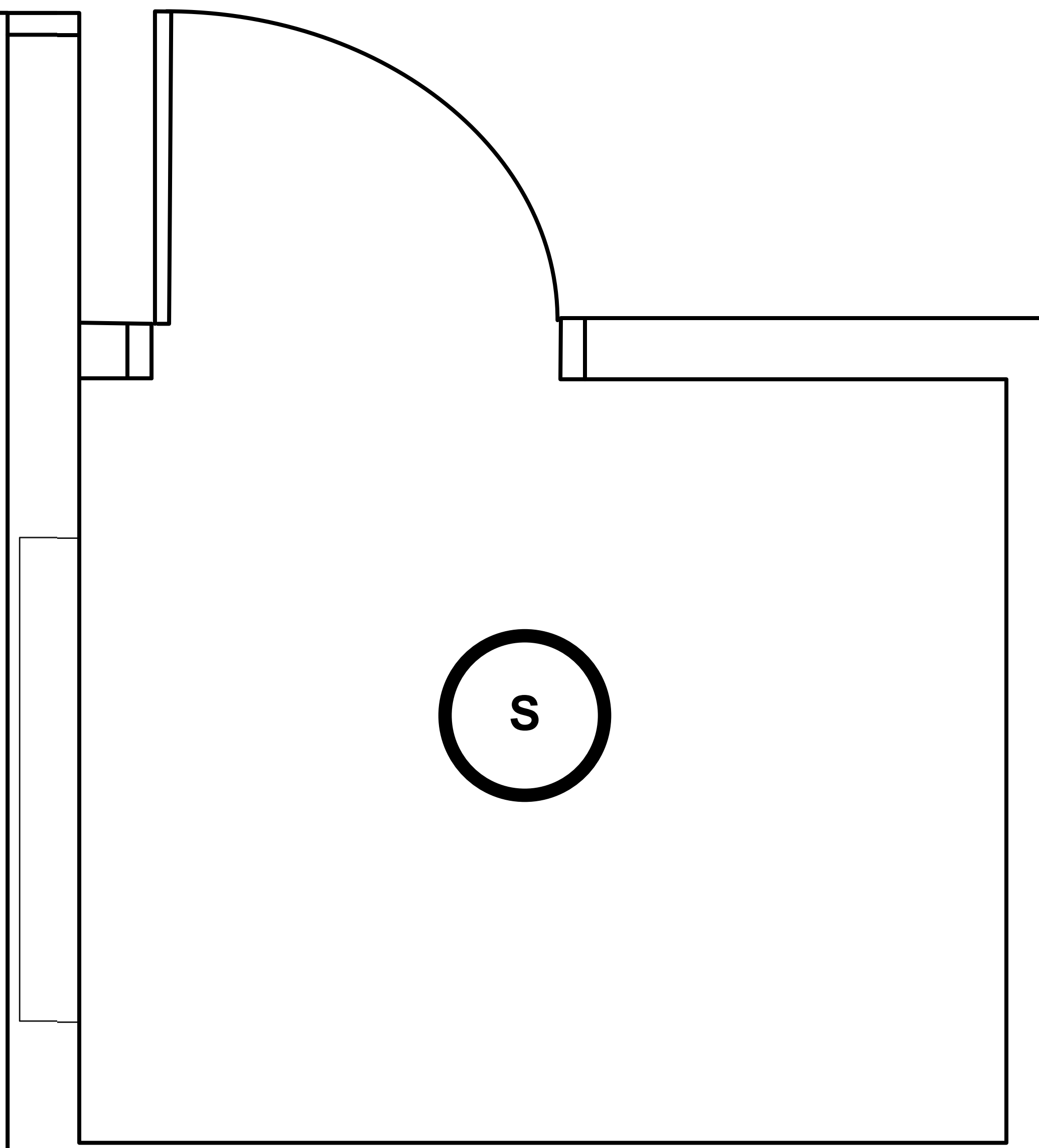
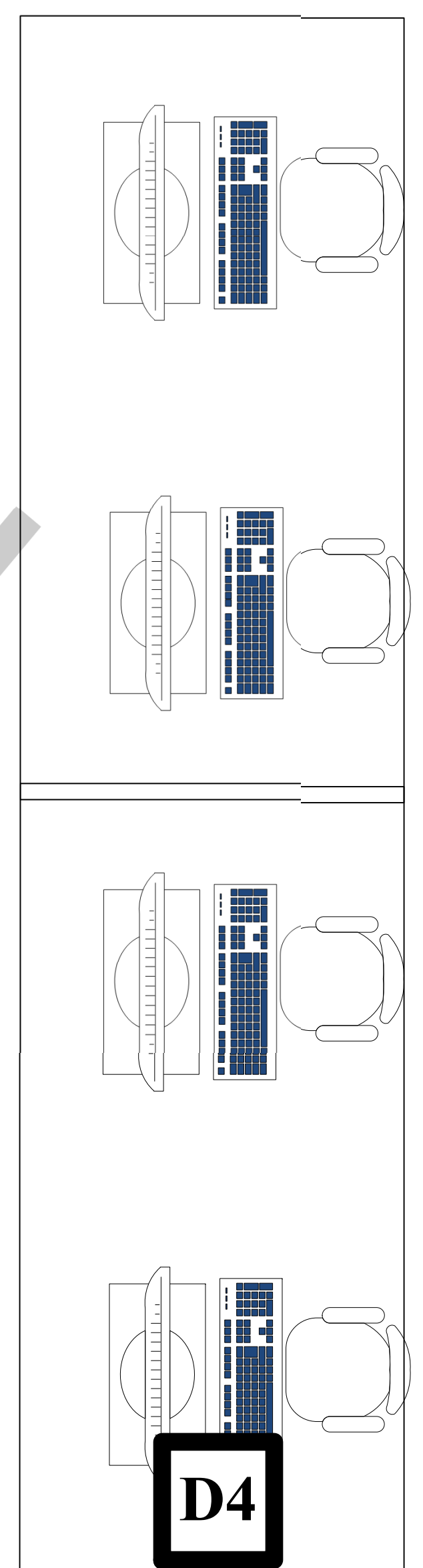
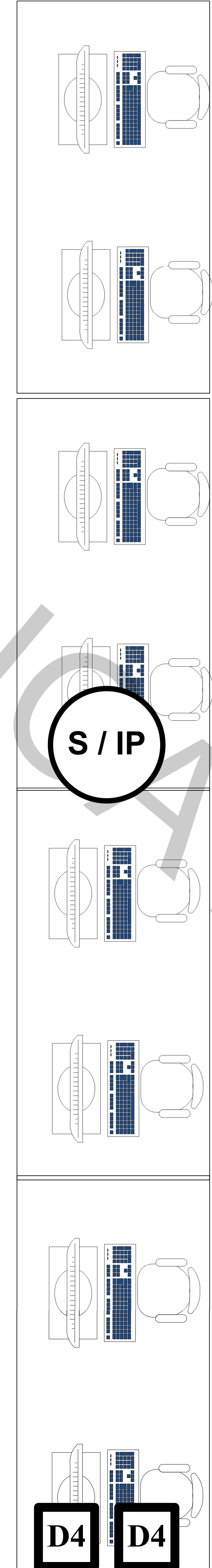
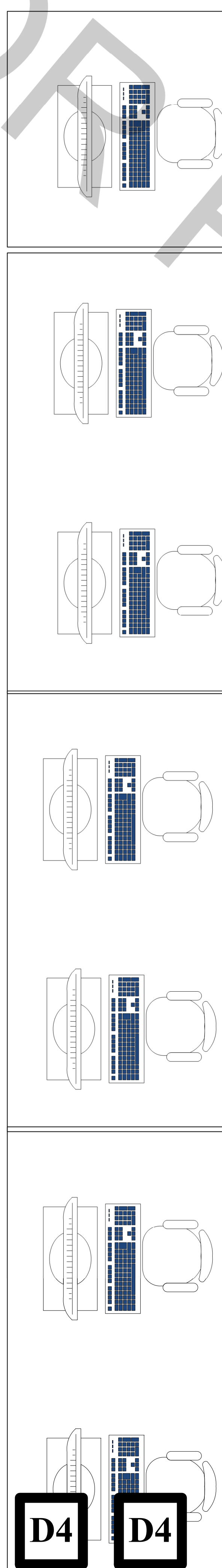
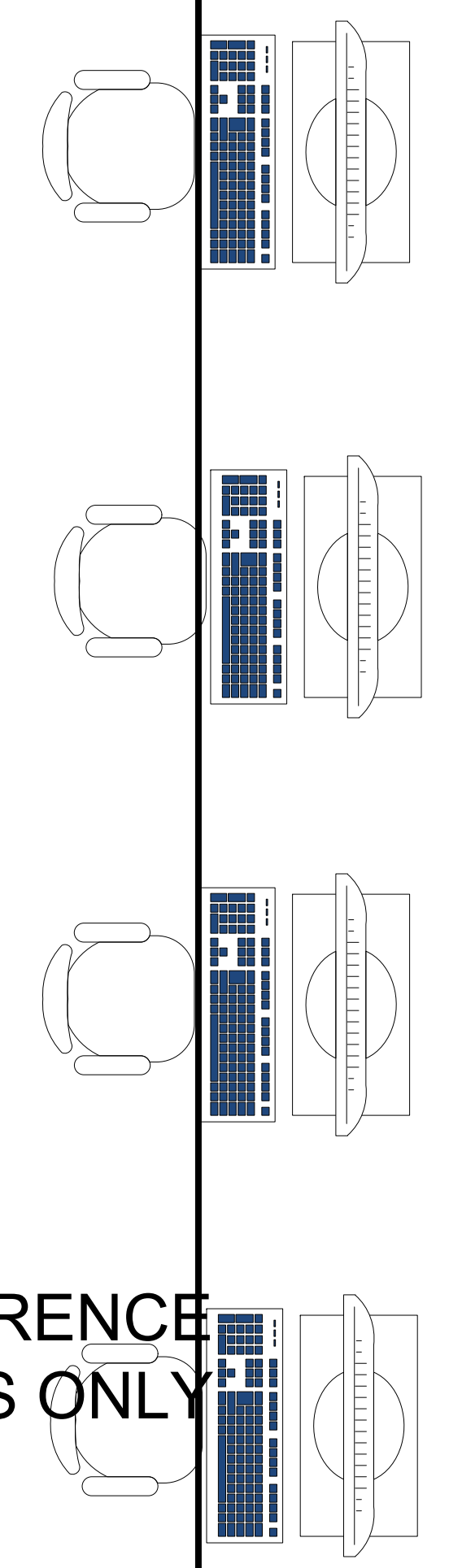

FOR REFERENCE
PURPOSES ONLY

STANDARD MIDDLE SCHOOL CLASSROOM "TYPICAL"

NOT TO SCALE

FOR REFERENCE
PURPOSES ONLY

FOR REFERENCE
PURPOSES ONLY

FOR REFERENCE
PURPOSES ONLY

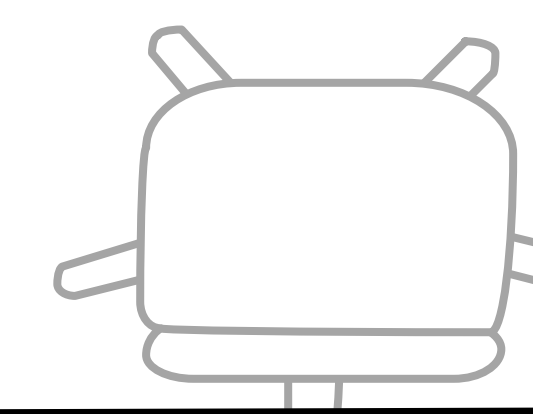
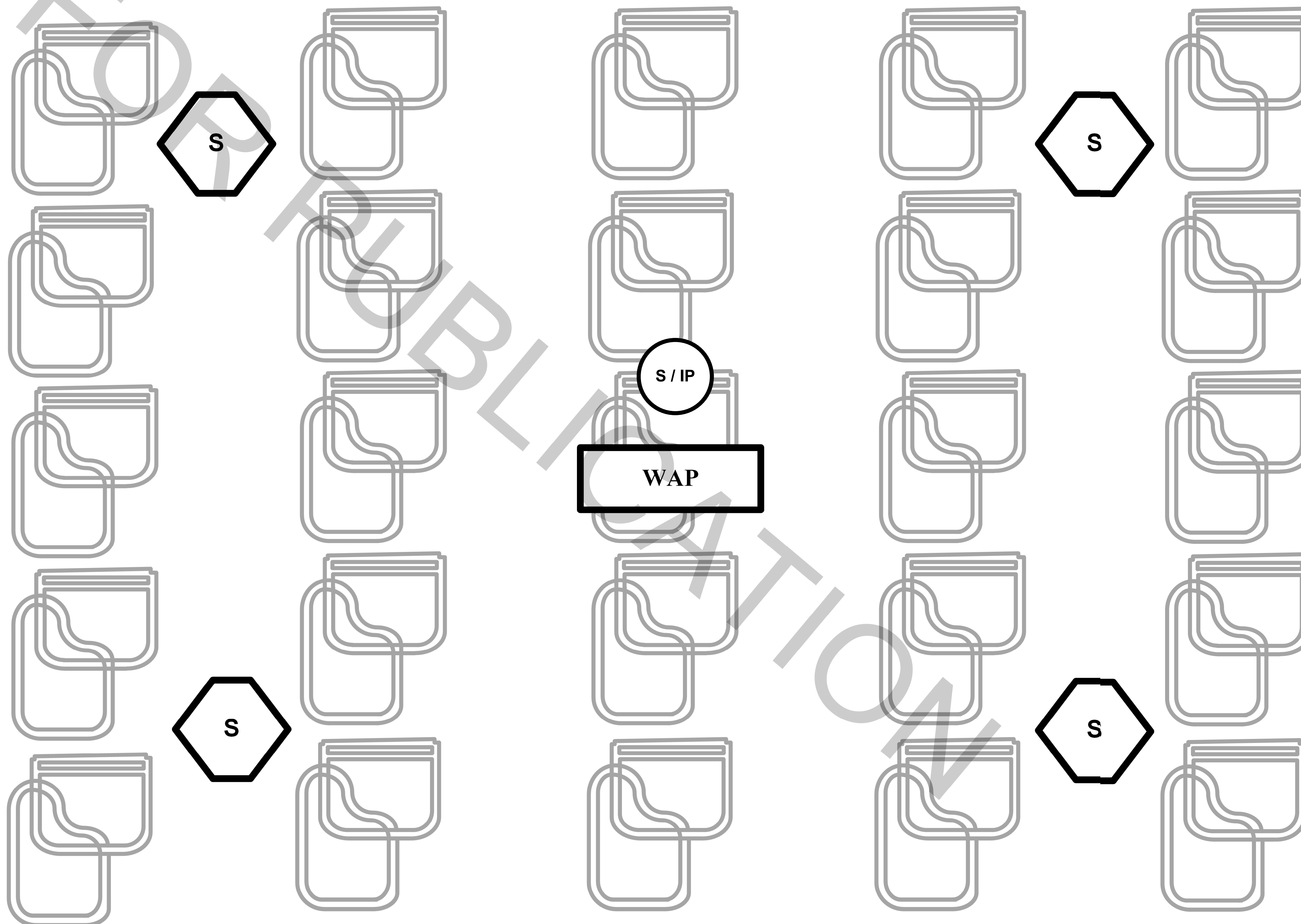
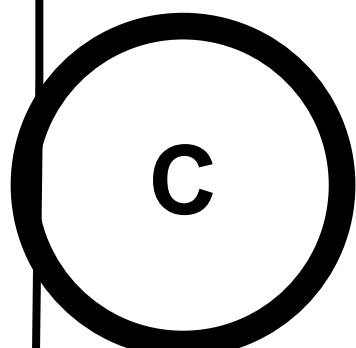

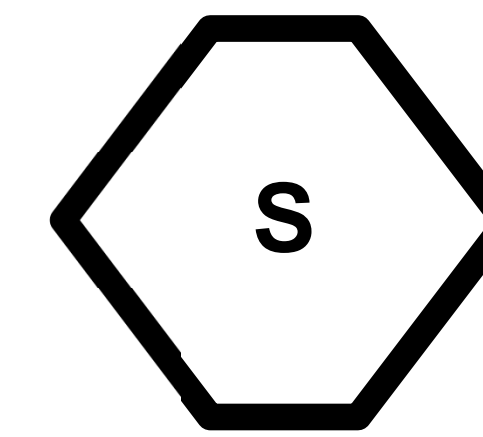
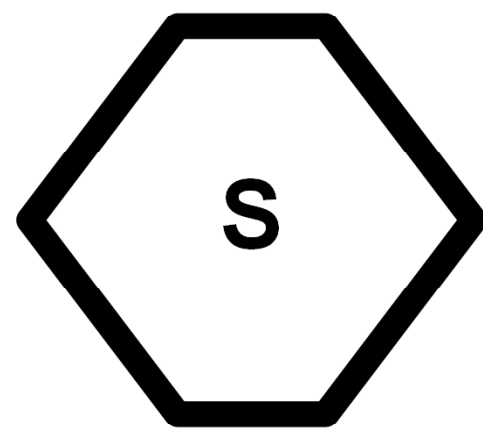
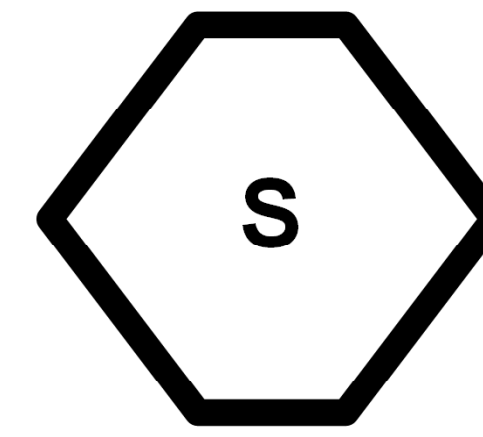
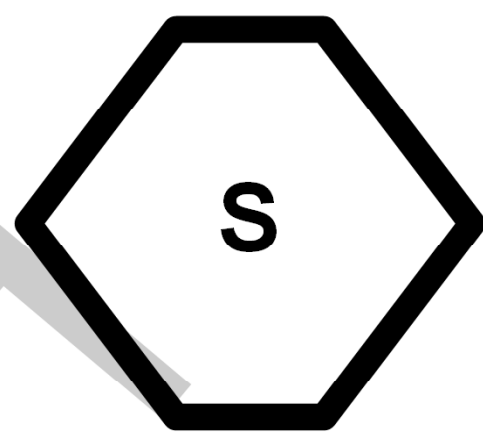
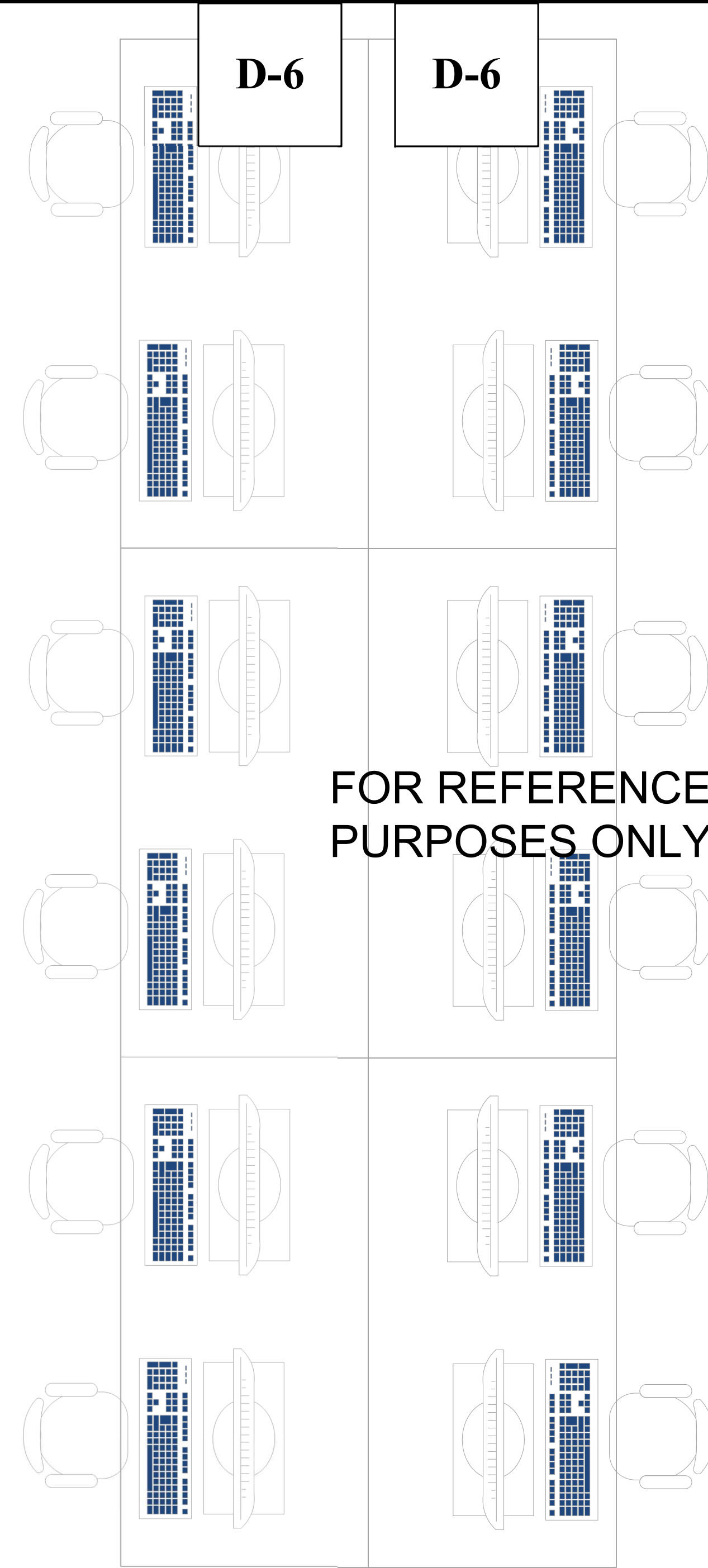
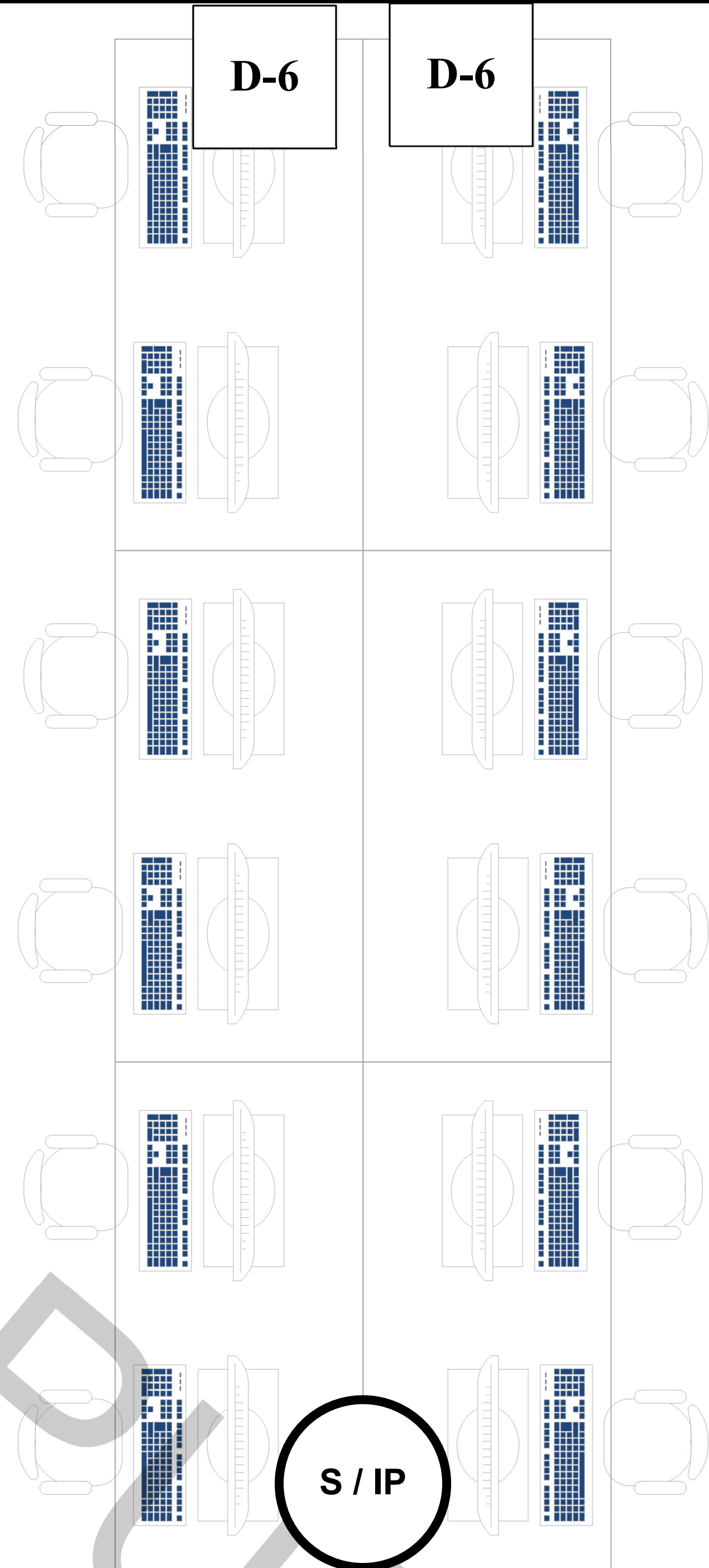
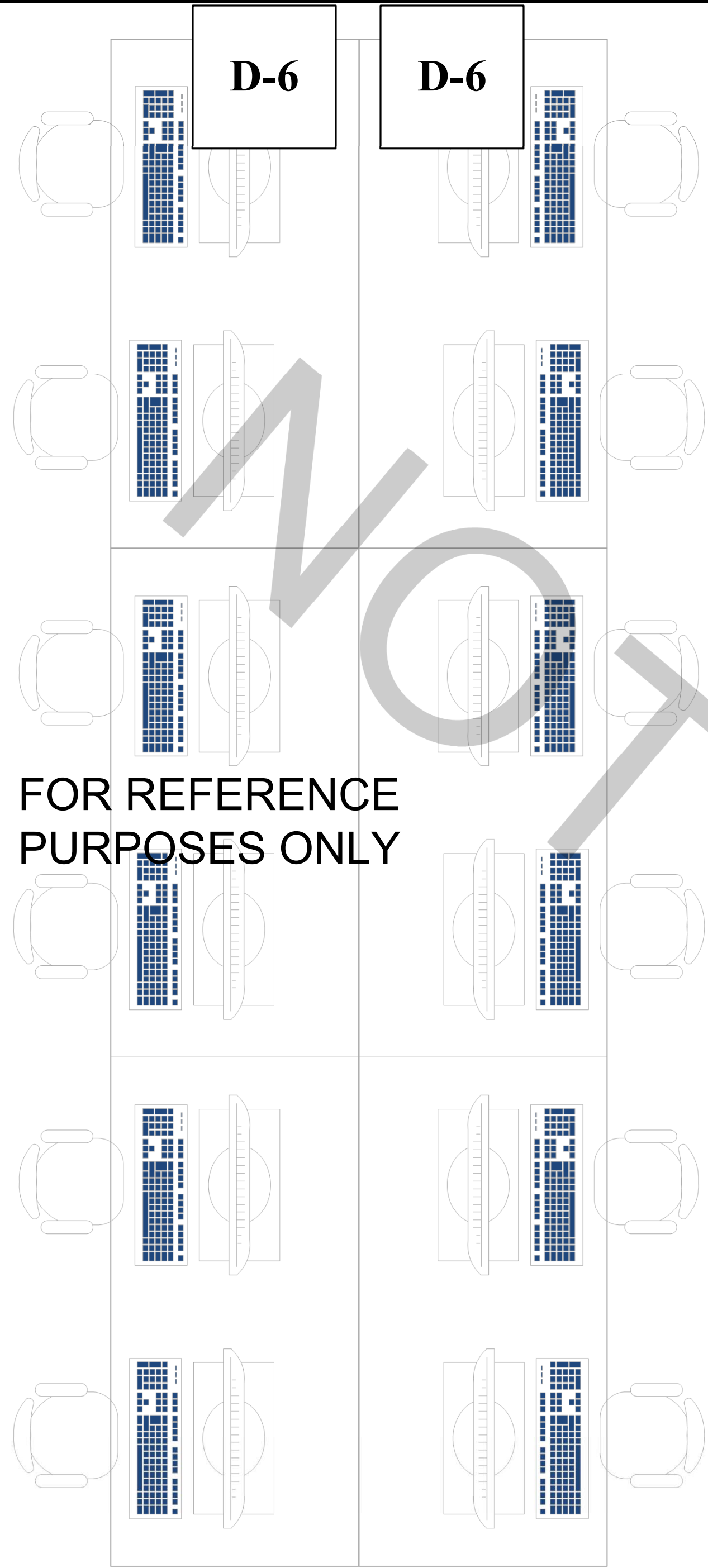

STANDARD MIDDLE SCHOOL SKILLS LAB "TYPICAL" "A" CONFIGURATION
NOT TO SCALE

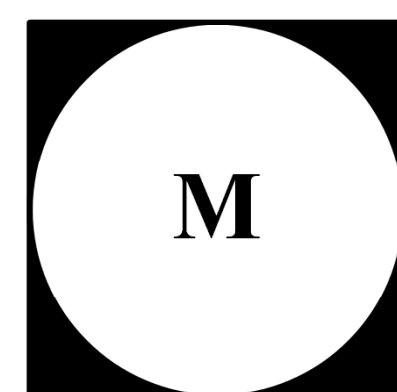

26" A.F.F.
AE JAR

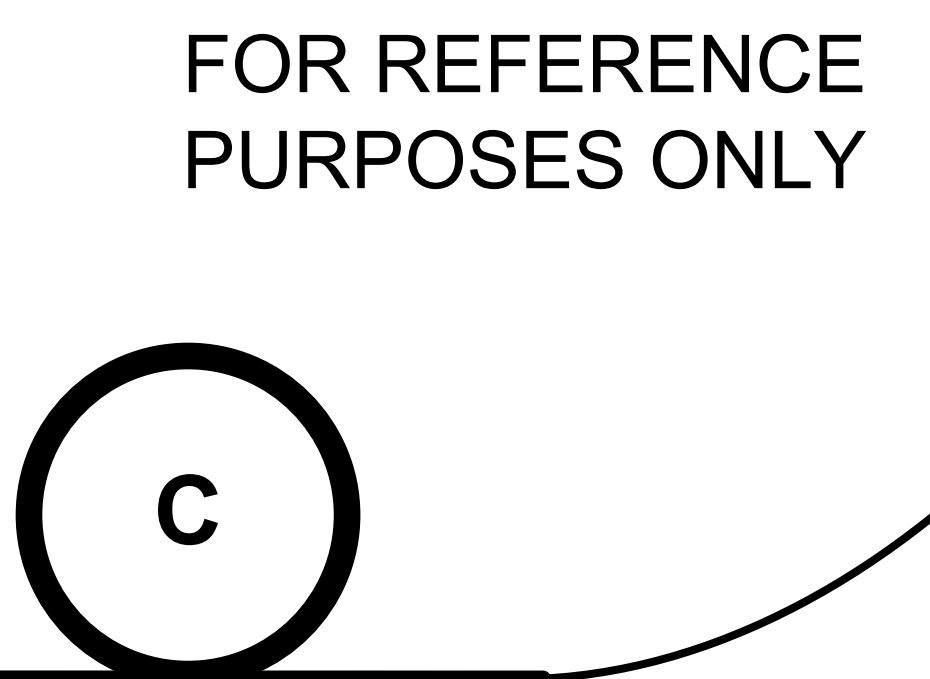
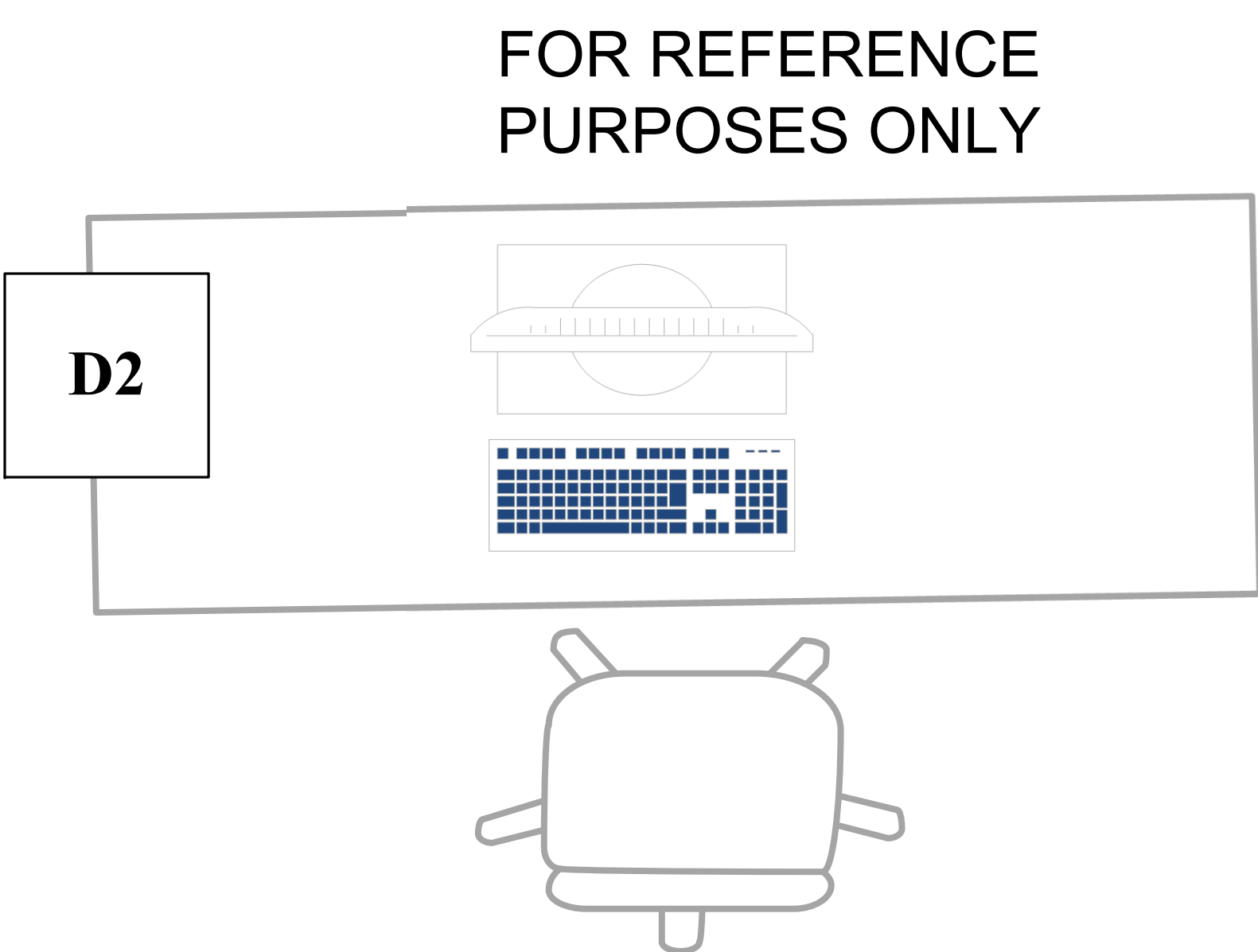

FOR REFERENCE
PURPOSES ONLY

FOR REFERENCE
PURPOSES ONLY

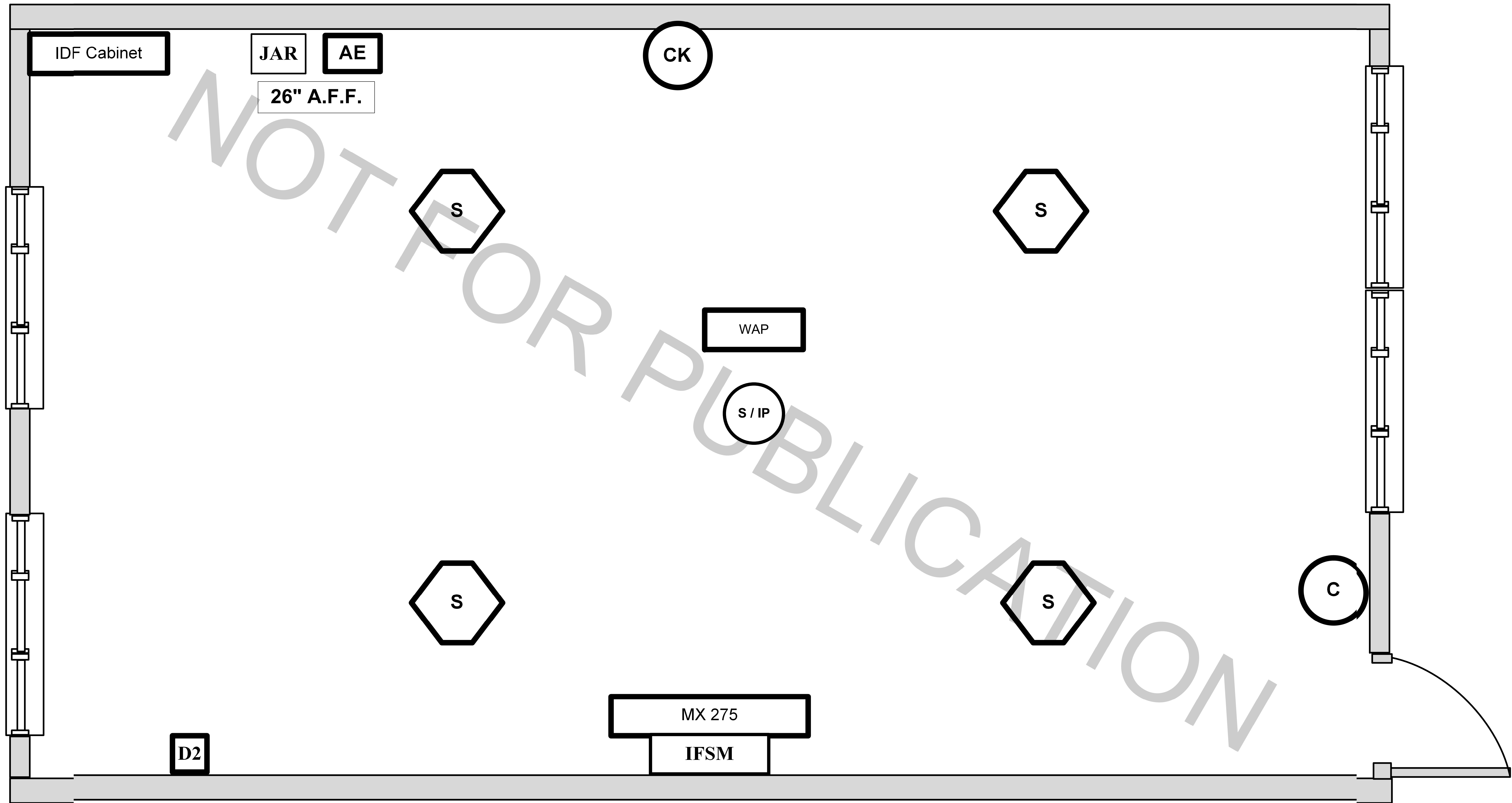

FOR REFERENCE
PURPOSES ONLY

FOR REFERENCE
PURPOSES ONLY

Portable Interior Layout Typical w/Teaching Wall

Not to Scale
All locations are approximations

FOR REFERENCE
PURPOSES ONLY

FOR REFERENCE
PURPOSES ONLY

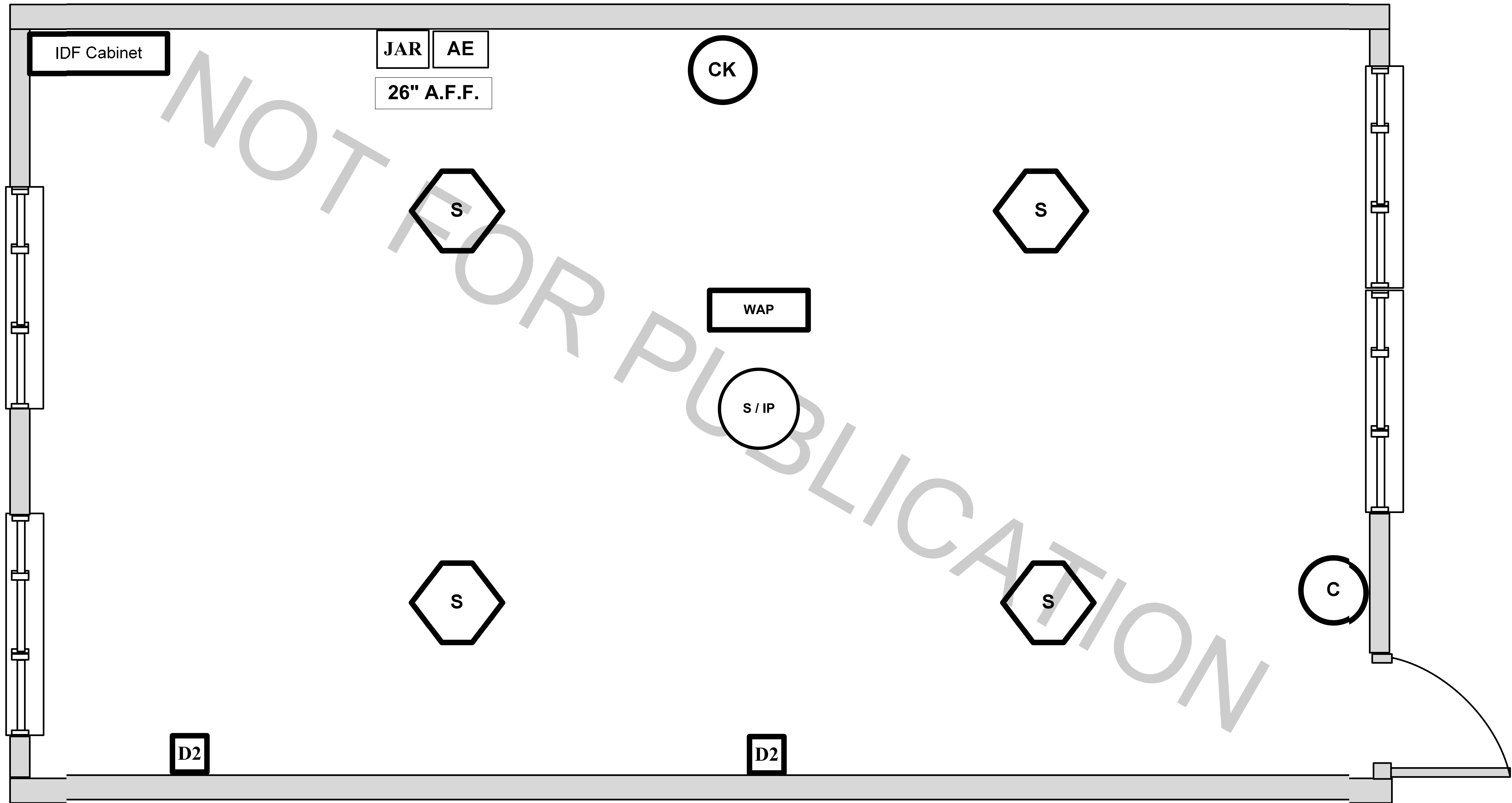

FOR REFERENCE
PURPOSES ONLY

FOR REFERENCE
PURPOSES ONLY

Portable Interior Layout Typical w/o Teaching Wall

Not to Scale
All locations are approximations

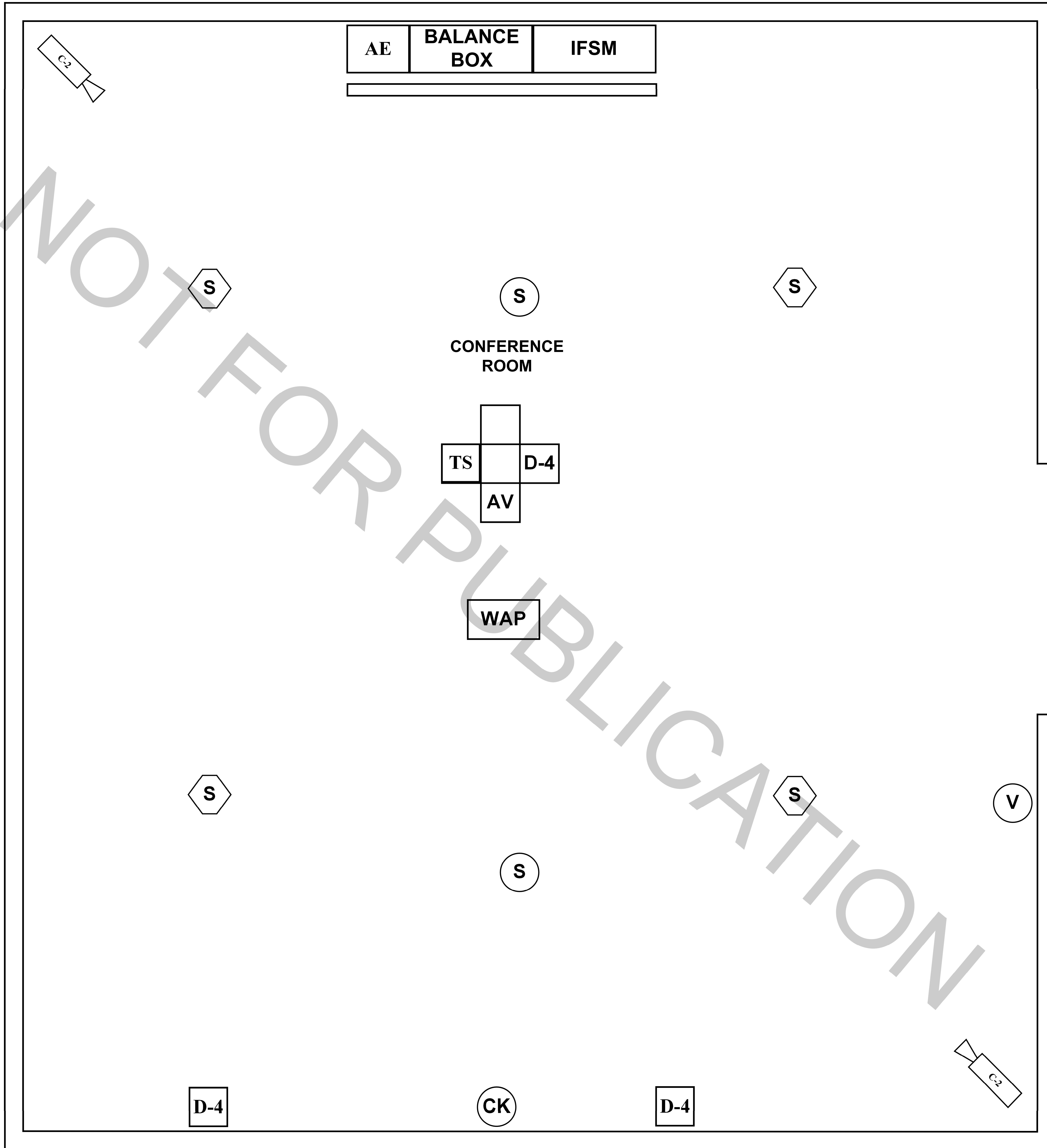

FOR REFERENCE
PURPOSES ONLY

TYPICAL CONFERENCE ROOM

NOT TO SCALE

FOR REFERENCE
PURPOSES ONLY

FOR REFERENCE PURPOSES ONLY

FOR REFERENCE PURPOSES ONLY

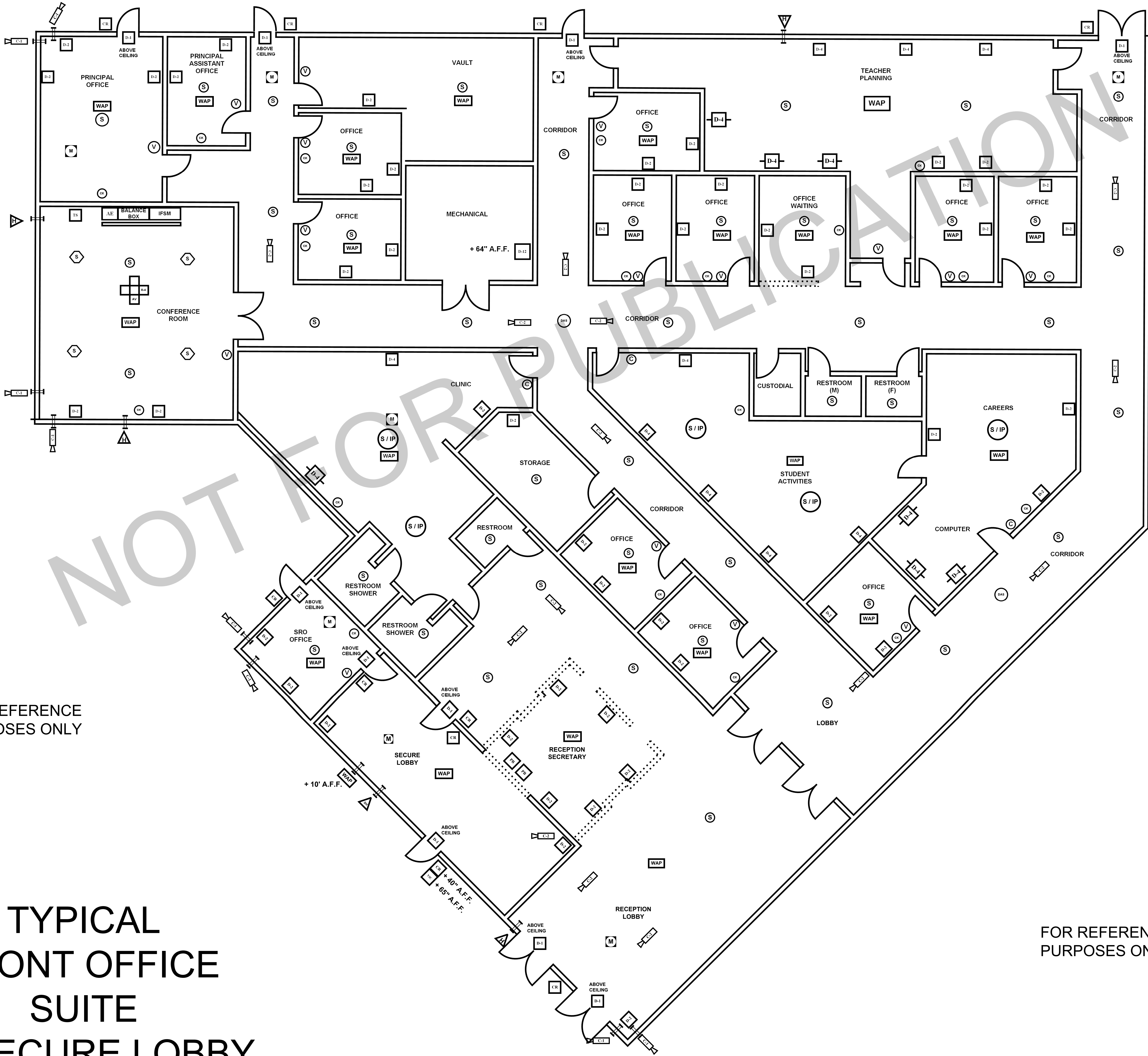

FOR REFERENCE PURPOSES ONLY

**TYPICAL
FRONT OFFICE
SUITE
W/ SECURE LOBBY**

NOT TO SCALE

FOR REFERENCE PURPOSES ONLY

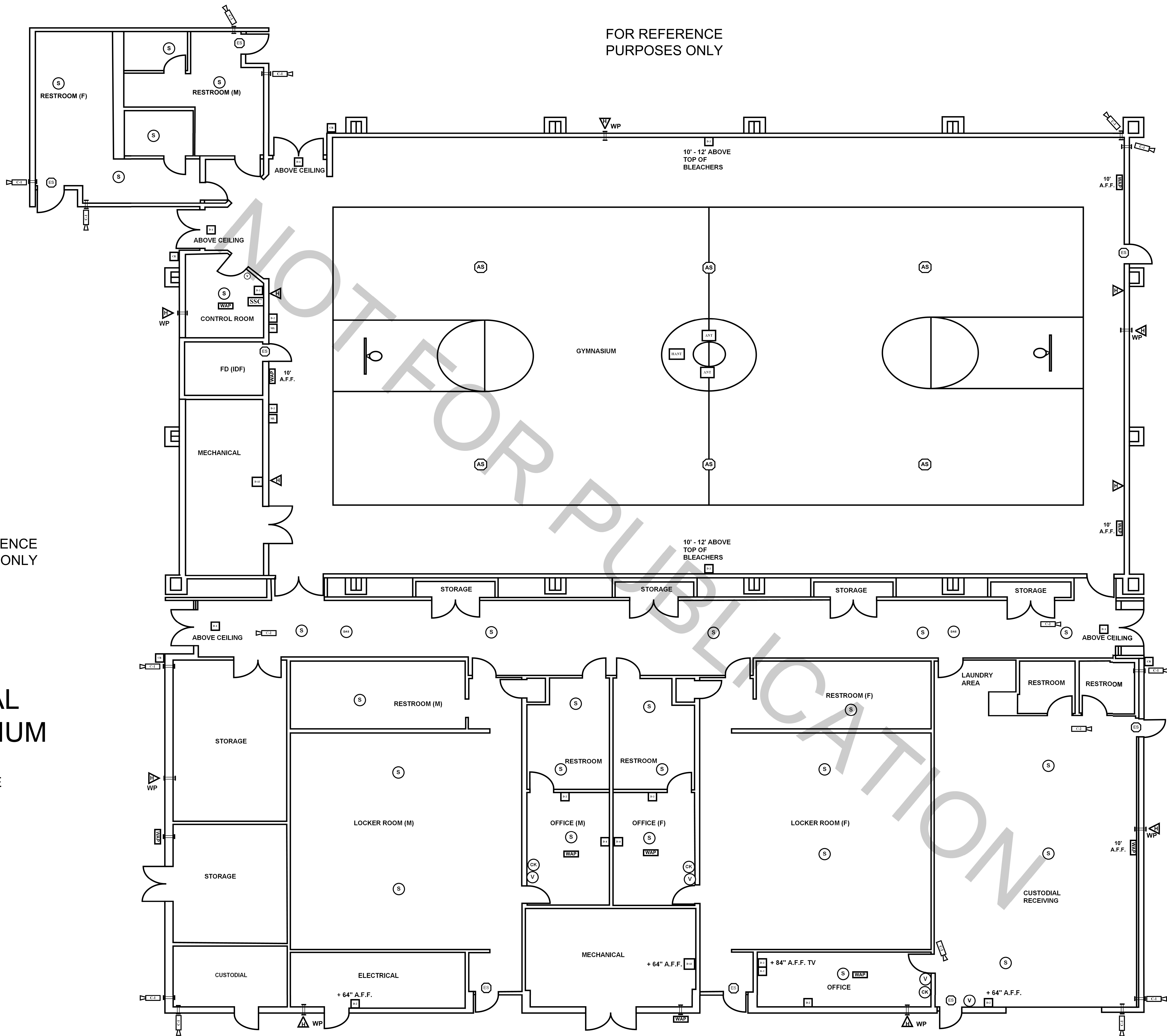

FOR REFERENCE
PURPOSES ONLY

FOR REFERENCE
PURPOSES ONLY

TYPICAL GYMNASIUM

NOT TO SCALE

FOR REFERENCE
PURPOSES ONLY

FOR REFERENCE
PURPOSES ONLY

FOR REFERENCE
PURPOSES ONLY

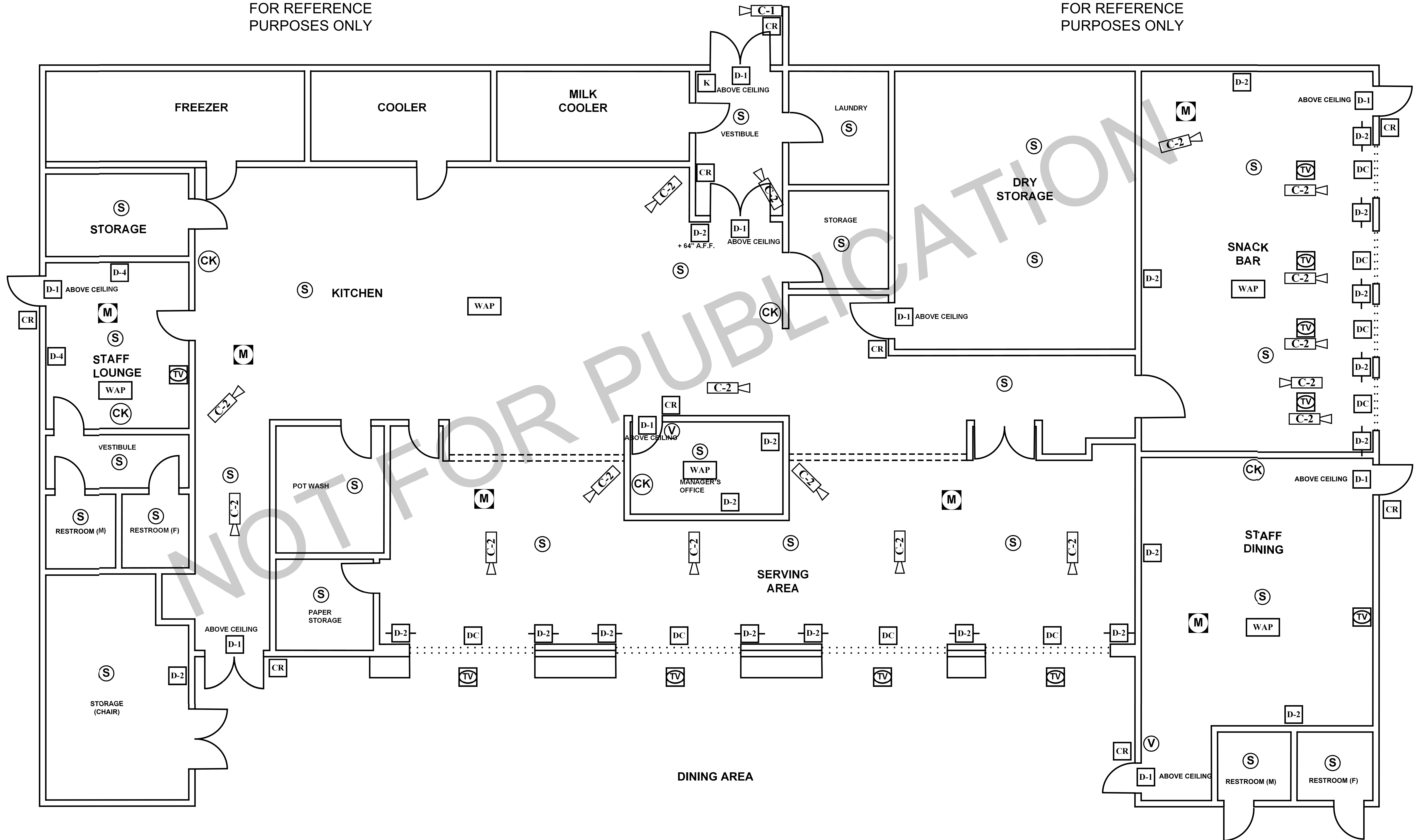

FOR REFERENCE
PURPOSES ONLY

FOR REFERENCE
PURPOSES ONLY

TYPICAL KITCHEN WITH SERVING AREA

NOT TO SCALE

FOR REFERENCE PURPOSES ONLY

FOR REFERENCE PURPOSES ONLY

TYPICAL MEDIA CENTER

NOT TO SCALE

FOR REFERENCE PURPOSES ONLY

FOR REFERENCE PURPOSES ONLY

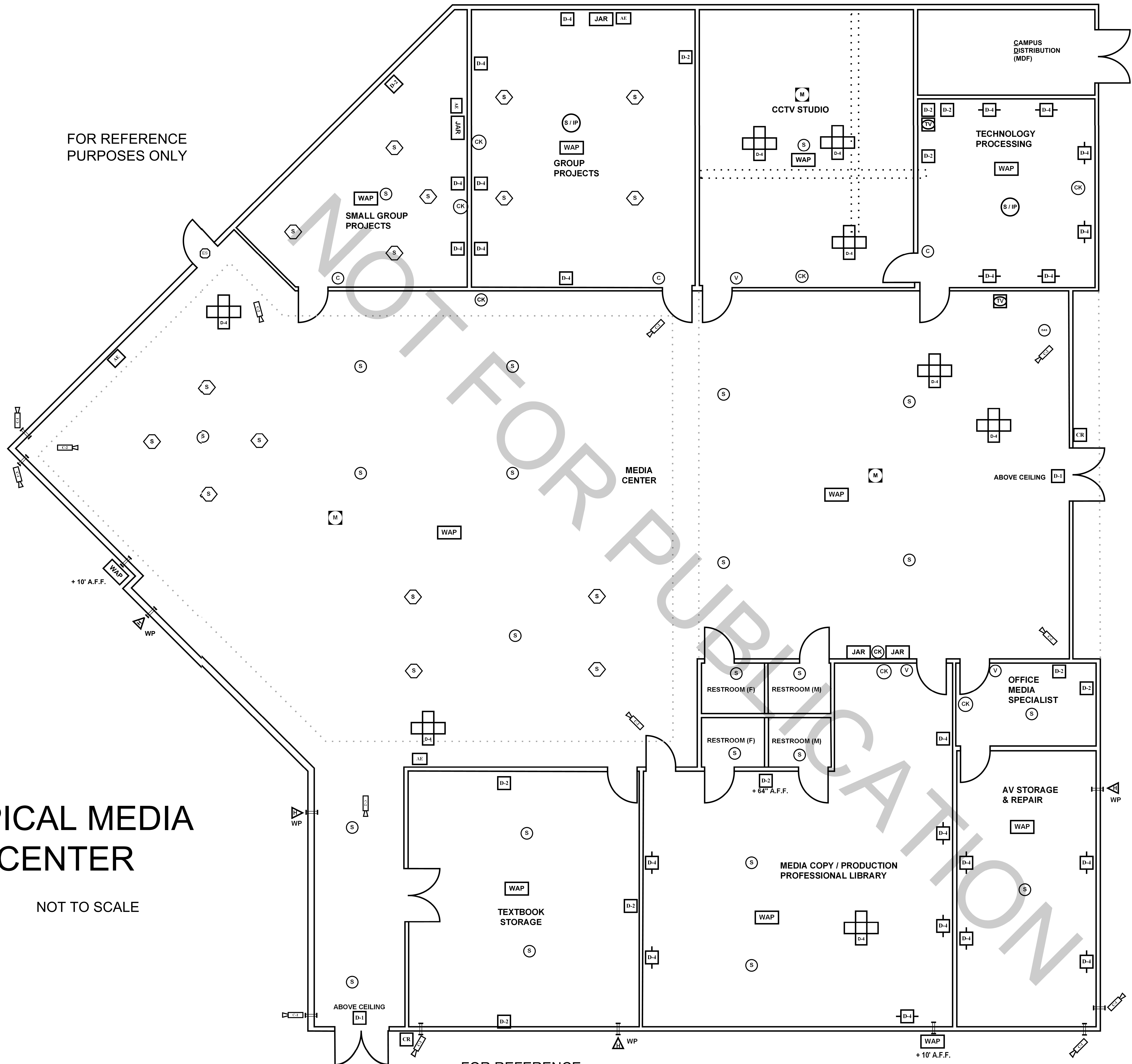

FOR REFERENCE
PURPOSES ONLY

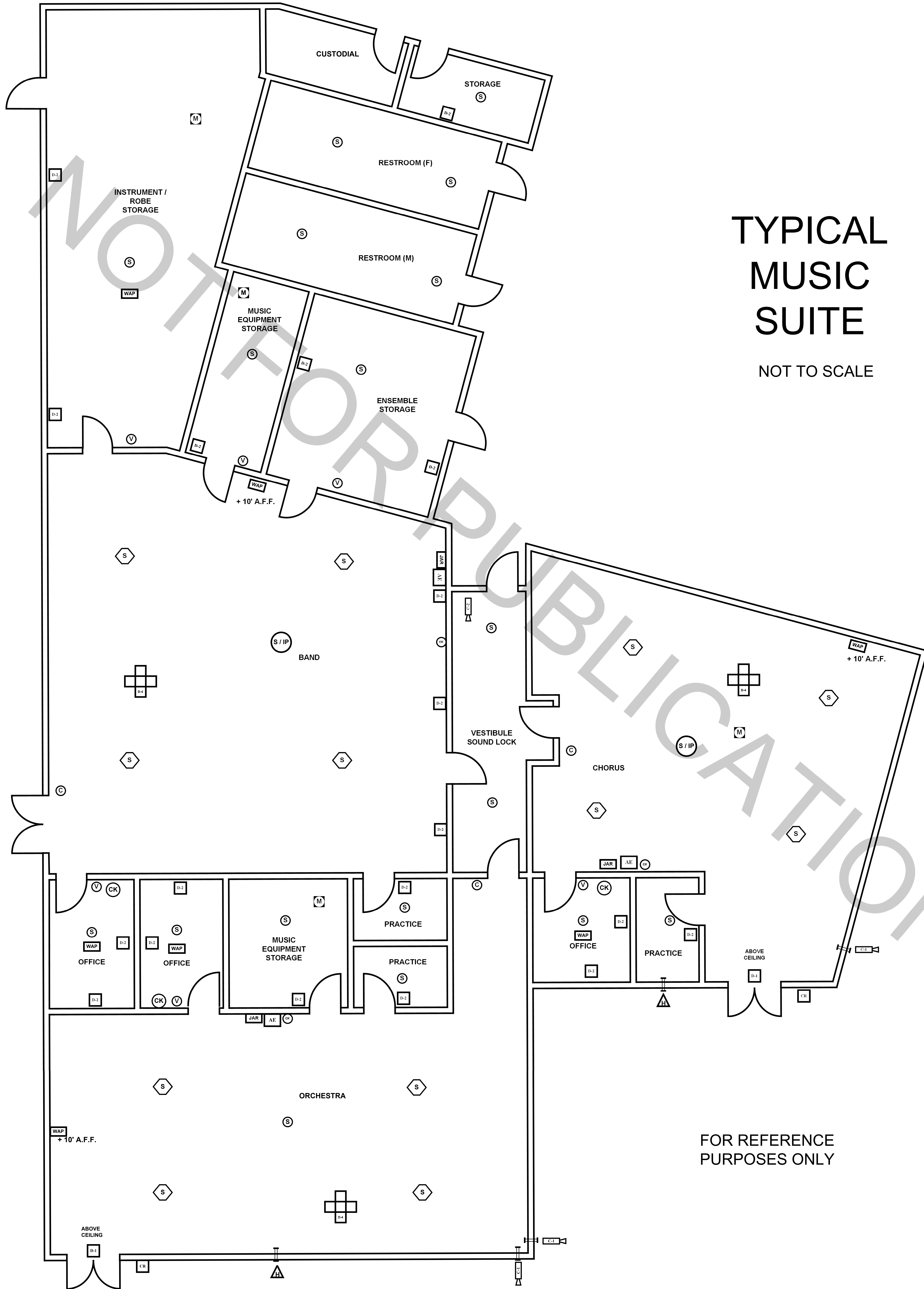

TYPICAL MUSIC SUITE

NOT TO SCALE

FOR REFERENCE
PURPOSES ONLY

FOR REFERENCE
PURPOSES ONLY

FOR REFERENCE PURPOSES ONLY

FOR REFERENCE PURPOSES ONLY

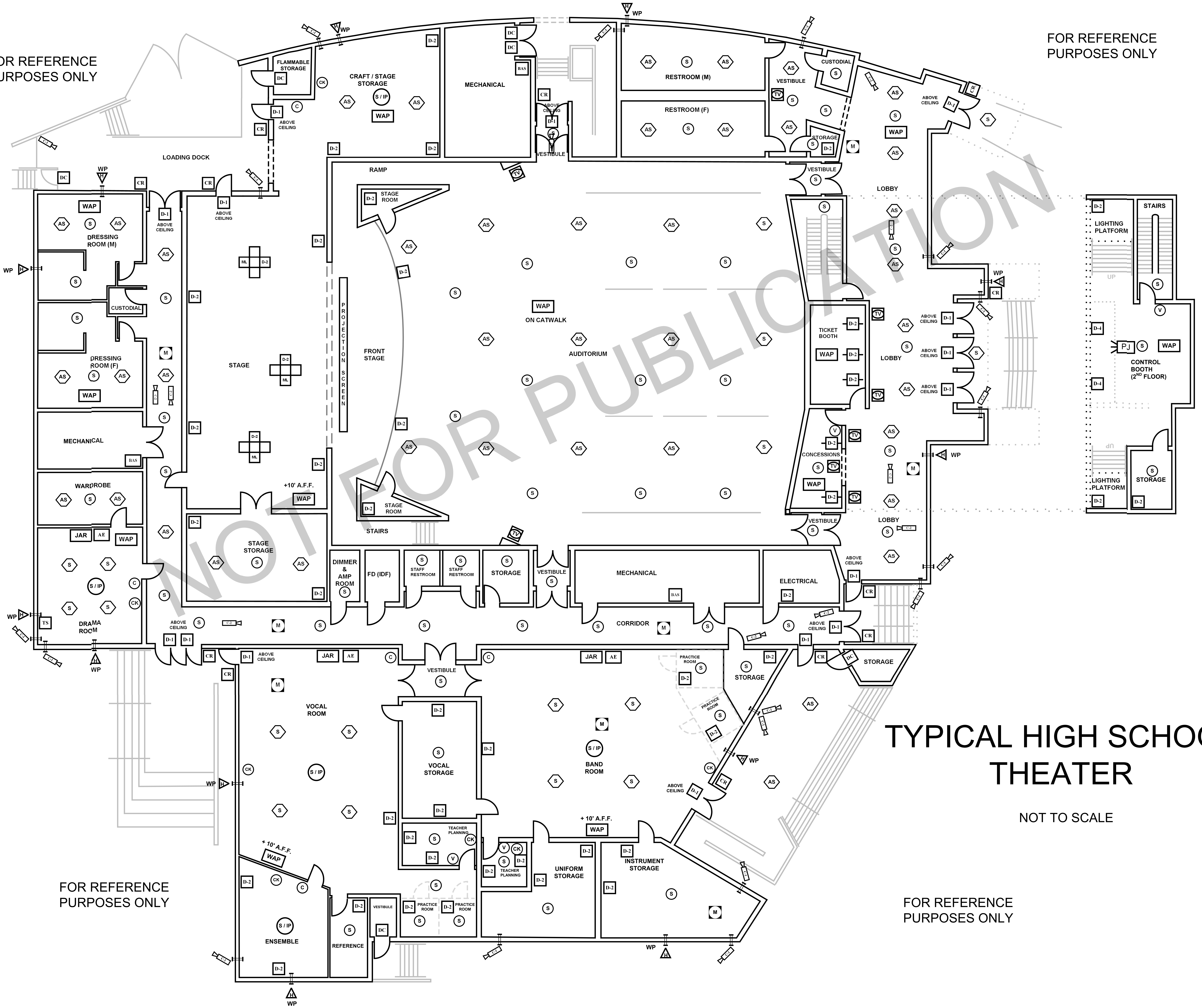

TYPICAL HIGH SCHOOL THEATER

NOT TO SCALE

FOR REFERENCE PURPOSES ONLY

FOR REFERENCE PURPOSES ONLY